

Operating Manual

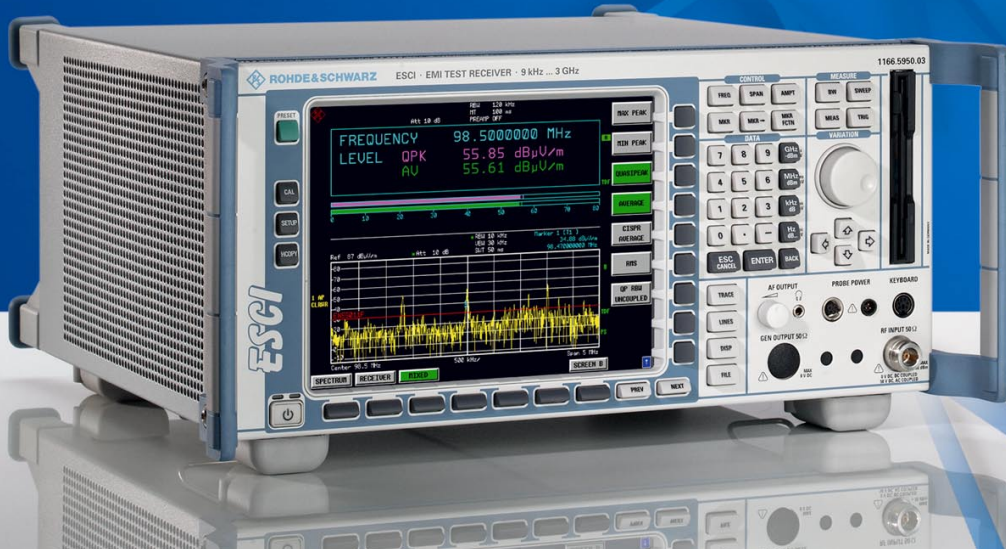

EMI Test Receiver

R&S® ESCI
1166.5950.03

This manual consists of 2 volumes:

Volume 1

Printed in the Federal
Republic of Germany



Dear Customer,

R&S® is a registered trademark of Rohde & Schwarz GmbH & Co. KG
Trade names are trademarks of the owners.

Tabbed Divider Overview

Volume 1 - Operating Manual - Manual Control

Data Sheet

Safety Instructions
Certificate of Quality
EU Certificate of Conformity
Support Center Address
List of R&S Representatives

Manuals for Test Receiver R&S ESCI

Tabbed Divider

1	Chapter 1:	Putting into Operation
2	Chapter 2:	Getting Started
3	Chapter 3:	Operation
4	Chapter 4:	Functional Description
5		Index

Volume 2 - Operating Manual - Remote Control

Safety Instructions

Tabbed Divider

5	Chapter 5:	Remote Control – Basics
6	Chapter 6:	Remote Control – Commands
7	Chapter 7:	Remote Control – Program Examples
8	Chapter 8:	Maintenance and Hardware Interfaces
9	Chapter 9:	Error Messages
10		Index



Before putting the product into operation for the first time, make sure to read the following



Safety Instructions

Rohde & Schwarz makes every effort to keep the safety standard of its products up to date and to offer its customers the highest possible degree of safety. Our products and the auxiliary equipment required for them are designed and tested in accordance with the relevant safety standards. Compliance with these standards is continuously monitored by our quality assurance system. This product has been designed and tested in accordance with the EC Certificate of Conformity and has left the manufacturer's plant in a condition fully complying with safety standards. To maintain this condition and to ensure safe operation, observe all instructions and warnings provided in this manual. If you have any questions regarding these safety instructions, Rohde & Schwarz will be happy to answer them.

Furthermore, it is your responsibility to use the product in an appropriate manner. This product is designed for use solely in industrial and laboratory environments or in the field and must not be used in any way that may cause personal injury or property damage. You are responsible if the product is used for an intention other than its designated purpose or in disregard of the manufacturer's instructions. The manufacturer shall assume no responsibility for such use of the product.

The product is used for its designated purpose if it is used in accordance with its operating manual and within its performance limits (see data sheet, documentation, the following safety instructions). Using the products requires technical skills and knowledge of English. It is therefore essential that the products be used exclusively by skilled and specialized staff or thoroughly trained personnel with the required skills. If personal safety gear is required for using Rohde & Schwarz products, this will be indicated at the appropriate place in the product documentation.

Symbols and safety labels

Observe operating instructions	Weight indication for units >18 kg	Danger of electric shock	Warning! Hot surface	PE terminal	Ground	Ground terminal	Attention! Electrostatic sensitive devices

Supply voltage ON/OFF	Standby indication	Direct current (DC)	Alternating current (AC)	Direct/alternating current (DC/AC)	Device fully protected by double/reinforced insulation

Safety Instructions

Observing the safety instructions will help prevent personal injury or damage of any kind caused by dangerous situations. Therefore, carefully read through and adhere to the following safety instructions before putting the product into operation. It is also absolutely essential to observe the additional safety instructions on personal safety that appear in other parts of the documentation. In these safety instructions, the word "product" refers to all merchandise sold and distributed by Rohde & Schwarz, including instruments, systems and all accessories.

Tags and their meaning

DANGER	This tag indicates a safety hazard with a high potential of risk for the user that can result in death or serious injuries.
WARNING	This tag indicates a safety hazard with a medium potential of risk for the user that can result in death or serious injuries.
CAUTION	This tag indicates a safety hazard with a low potential of risk for the user that can result in slight or minor injuries.
ATTENTION	This tag indicates the possibility of incorrect use that can cause damage to the product.
NOTE	This tag indicates a situation where the user should pay special attention to operating the product but which does not lead to damage.

These tags are in accordance with the standard definition for civil applications in the European Economic Area. Definitions that deviate from the standard definition may also exist. It is therefore essential to make sure that the tags described here are always used only in connection with the associated documentation and the associated product. The use of tags in connection with unassociated products or unassociated documentation can result in misinterpretations and thus contribute to personal injury or material damage.

Basic safety instructions

1. The product may be operated only under the operating conditions and in the positions specified by the manufacturer. Its ventilation must not be obstructed during operation. Unless otherwise specified, the following requirements apply to Rohde & Schwarz products:
prescribed operating position is always with the housing floor facing down, IP protection 2X, pollution severity 2, overvoltage category 2, use only in enclosed spaces, max. operation altitude max. 2000 m. Unless specified otherwise in the data sheet, a tolerance of $\pm 10\%$ shall apply to the nominal voltage and of $\pm 5\%$ to the nominal frequency.
2. Applicable local or national safety regulations and rules for the prevention of accidents must be observed in all work performed. The product may be opened only by authorized, specially trained personnel. Prior to performing any work on the product or opening the product, the product must be disconnected from the supply network. Any adjustments, replacements of parts, maintenance or repair must be carried out only by technical personnel authorized by Rohde & Schwarz. Only original parts may be used for replacing parts relevant to safety (e.g. power switches, power transformers, fuses). A safety test must always be performed after parts relevant to safety have been replaced (visual inspection, PE conductor test, insulation resistance measurement, leakage current measurement, functional test).
3. As with all industrially manufactured goods, the use of substances that induce an allergic reaction (allergens, e.g. nickel) such as aluminum cannot be generally excluded. If you develop an allergic reaction (such as a skin rash, frequent sneezing, red eyes or respiratory difficulties), consult a physician immediately to determine the cause.

Safety Instructions

4. If products/components are mechanically and/or thermally processed in a manner that goes beyond their intended use, hazardous substances (heavy-metal dust such as lead, beryllium, nickel) may be released. For this reason, the product may only be disassembled, e.g. for disposal purposes, by specially trained personnel. Improper disassembly may be hazardous to your health. National waste disposal regulations must be observed.
5. If handling the product yields hazardous substances or fuels that must be disposed of in a special way, e.g. coolants or engine oils that must be replenished regularly, the safety instructions of the manufacturer of the hazardous substances or fuels and the applicable regional waste disposal regulations must be observed. Also observe the relevant safety instructions in the product documentation.
6. Depending on the function, certain products such as RF radio equipment can produce an elevated level of electromagnetic radiation. Considering that unborn life requires increased protection, pregnant women should be protected by appropriate measures. Persons with pacemakers may also be endangered by electromagnetic radiation. The employer is required to assess workplaces where there is a special risk of exposure to radiation and, if necessary, take measures to avert the danger.
7. Operating the products requires special training and intense concentration. Make certain that persons who use the products are physically, mentally and emotionally fit enough to handle operating the products; otherwise injuries or material damage may occur. It is the responsibility of the employer to select suitable personnel for operating the products.
8. Prior to switching on the product, it must be ensured that the nominal voltage setting on the product matches the nominal voltage of the AC supply network. If a different voltage is to be set, the power fuse of the product may have to be changed accordingly.
9. In the case of products of safety class I with movable power cord and connector, operation is permitted only on sockets with earthing contact and protective earth connection.
10. Intentionally breaking the protective earth connection either in the feed line or in the product itself is not permitted. Doing so can result in the danger of an electric shock from the product. If extension cords or connector strips are implemented, they must be checked on a regular basis to ensure that they are safe to use.
11. If the product has no power switch for disconnection from the AC supply, the plug of the connecting cable is regarded as the disconnecting device. In such cases, it must be ensured that the power plug is easily reachable and accessible at all times (length of connecting cable approx. 2 m). Functional or electronic switches are not suitable for providing disconnection from the AC supply. If products without power switches are integrated in racks or systems, a disconnecting device must be provided at the system level.
12. Never use the product if the power cable is damaged. By taking appropriate safety measures and carefully laying the power cable, ensure that the cable cannot be damaged and that no one can be hurt by e.g. tripping over the cable or suffering an electric shock.
13. The product may be operated only from TN/TT supply networks fused with max. 16 A.
14. Do not insert the plug into sockets that are dusty or dirty. Insert the plug firmly and all the way into the socket. Otherwise this can result in sparks, fire and/or injuries.
15. Do not overload any sockets, extension cords or connector strips; doing so can cause fire or electric shocks.
16. For measurements in circuits with voltages $V_{rms} > 30 V$, suitable measures (e.g. appropriate measuring equipment, fusing, current limiting, electrical separation, insulation) should be taken to avoid any hazards.
17. Ensure that the connections with information technology equipment comply with IEC 950/EN 60950.
18. Never remove the cover or part of the housing while you are operating the product. This will expose circuits and components and can lead to injuries, fire or damage to the product.

Safety Instructions

19. If a product is to be permanently installed, the connection between the PE terminal on site and the product's PE conductor must be made first before any other connection is made. The product may be installed and connected only by a skilled electrician.
20. For permanently installed equipment without built-in fuses, circuit breakers or similar protective devices, the supply circuit must be fused in such a way that suitable protection is provided for users and products.
21. Do not insert any objects into the openings in the housing that are not designed for this purpose. Never pour any liquids onto or into the housing. This can cause short circuits inside the product and/or electric shocks, fire or injuries.
22. Use suitable overvoltage protection to ensure that no overvoltage (such as that caused by a thunderstorm) can reach the product. Otherwise the operating personnel will be endangered by electric shocks.
23. Rohde & Schwarz products are not protected against penetration of water, unless otherwise specified (see also safety instruction 1.). If this is not taken into account, there exists the danger of electric shock or damage to the product, which can also lead to personal injury.
24. Never use the product under conditions in which condensation has formed or can form in or on the product, e.g. if the product was moved from a cold to a warm environment.
25. Do not close any slots or openings on the product, since they are necessary for ventilation and prevent the product from overheating. Do not place the product on soft surfaces such as sofas or rugs or inside a closed housing, unless this is well ventilated.
26. Do not place the product on heat-generating devices such as radiators or fan heaters. The temperature of the environment must not exceed the maximum temperature specified in the data sheet.
27. Batteries and storage batteries must not be exposed to high temperatures or fire. Keep batteries and storage batteries away from children. If batteries or storage batteries are improperly replaced, this can cause an explosion (warning: lithium cells). Replace the battery or storage battery only with the matching Rohde & Schwarz type (see spare parts list). Batteries and storage batteries are hazardous waste. Dispose of them only in specially marked containers. Observe local regulations regarding waste disposal. Do not short-circuit batteries or storage batteries.
28. Please be aware that in the event of a fire, toxic substances (gases, liquids etc.) that may be hazardous to your health may escape from the product.
29. Please be aware of the weight of the product. Be careful when moving it; otherwise you may injure your back or other parts of your body.
30. Do not place the product on surfaces, vehicles, cabinets or tables that for reasons of weight or stability are unsuitable for this purpose. Always follow the manufacturer's installation instructions when installing the product and fastening it to objects or structures (e.g. walls and shelves).
31. Handles on the products are designed exclusively for personnel to hold or carry the product. It is therefore not permissible to use handles for fastening the product to or on means of transport such as cranes, fork lifts, wagons, etc. The user is responsible for securely fastening the products to or on the means of transport and for observing the safety regulations of the manufacturer of the means of transport. Noncompliance can result in personal injury or material damage.
32. If you use the product in a vehicle, it is the sole responsibility of the driver to drive the vehicle safely. Adequately secure the product in the vehicle to prevent injuries or other damage in the event of an accident. Never use the product in a moving vehicle if doing so could distract the driver of the vehicle. The driver is always responsible for the safety of the vehicle; the manufacturer assumes no responsibility for accidents or collisions.
33. If a laser product (e.g. a CD/DVD drive) is integrated in a Rohde & Schwarz product, do not use any other settings or functions than those described in the documentation. Otherwise this may be hazardous to your health, since the laser beam can cause irreversible damage to your eyes. Never try to take such products apart, and never look into the laser beam.



Por favor lea imprescindiblemente antes de la primera puesta en funcionamiento las siguientes informaciones de seguridad



Informaciones de seguridad

Es el principio de Rohde & Schwarz de tener a sus productos siempre al día con los estándares de seguridad y de ofrecer a sus clientes el máximo grado de seguridad. Nuestros productos y todos los equipos adicionales son siempre fabricados y examinados según las normas de seguridad vigentes. Nuestra sección de gestión de la seguridad de calidad controla constantemente que sean cumplidas estas normas. Este producto ha sido fabricado y examinado según el comprobante de conformidad adjunto según las normas de la CE y ha salido de nuestra planta en estado impecable según los estándares técnicos de seguridad. Para poder preservar este estado y garantizar un funcionamiento libre de peligros, deberá el usuario atenerse a todas las informaciones, informaciones de seguridad y notas de alerta. Rohde&Schwarz está siempre a su disposición en caso de que tengan preguntas referentes a estas informaciones de seguridad.

Además queda en la responsabilidad del usuario utilizar el producto en la forma debida. Este producto solamente fue elaborado para ser utilizado en la industria y el laboratorio o para fines de campo y de ninguna manera deberá ser utilizado de modo que alguna persona/cosa pueda ser dañada. El uso del producto fuera de sus fines definidos o despreciando las informaciones de seguridad del fabricante queda en la responsabilidad del usuario. El fabricante no se hace en ninguna forma responsable de consecuencias a causa del maluso del producto.

Se parte del uso correcto del producto para los fines definidos si el producto es utilizado dentro de las instrucciones del correspondiente manual del uso y dentro del margen de rendimiento definido (ver hoja de datos, documentación, informaciones de seguridad que siguen). El uso de los productos hace necesarios conocimientos profundos y el conocimiento del idioma inglés. Por eso se deberá tener en cuenta de exclusivamente autorizar para el uso de los productos a personas péritas o debidamente minuciosamente instruidas con los conocimientos citados. Si fuera necesaria indumentaria de seguridad para el uso de productos de R&S, encontrará la información debida en la documentación del producto en el capítulo correspondiente.

Símbolos y definiciones de seguridad

Ver manual de instrucciones del uso	Informaciones para maquinaria con un peso de > 18kg	Peligro de golpe de corriente	¡Advertencia! Superficie caliente	Conexión a conductor protector	Conexión a tierra	Conexión a masa conductora	¡Cuidado! Elementos de construcción con peligro de carga electrostática

potencia EN MARCHA/PARADA	Indicación Stand-by	Corriente continua DC	Corriente alterna AC	Corriente continua/alterna DC/AC	El aparato está protegido en su totalidad por un aislamiento de doble refuerzo

Informaciones de seguridad

Tener en cuenta las informaciones de seguridad sirve para tratar de evitar daños y peligros de toda clase. Es necesario de que se lean las siguientes informaciones de seguridad concienzudamente y se tengan en cuenta debidamente antes de la puesta en funcionamiento del producto. También deberán ser tenidas en cuenta las informaciones para la protección de personas que encontrarán en otro capítulo de esta documentación y que también son obligatorias de seguir. En las informaciones de seguridad actuales hemos juntado todos los objetos vendidos por Rohde&Schwarz bajo la denominación de „producto“, entre ellos también aparatos, instalaciones así como toda clase de accesorios.

Palabras de señal y su significado

PELIGRO	Indica un punto de peligro con gran potencial de riesgo para el usuario. Punto de peligro que puede llevar hasta la muerte o graves heridas.
ADVERTENCIA	Indica un punto de peligro con un potencial de riesgo mediano para el usuario. Punto de peligro que puede llevar hasta la muerte o graves heridas .
ATENCIÓN	Indica un punto de peligro con un potencial de riesgo pequeño para el usuario. Punto de peligro que puede llevar hasta heridas leves o pequeñas
CUIDADO	Indica la posibilidad de utilizar mal el producto y a consecuencia dañarlo.
INFORMACIÓN	Indica una situación en la que deberían seguirse las instrucciones en el uso del producto, pero que no consecuentemente deben de llevar a un daño del mismo.

Las palabras de señal corresponden a la definición habitual para aplicaciones civiles en el ámbito de la comunidad económica europea. Pueden existir definiciones diferentes a esta definición. Por eso se debiera tener en cuenta que las palabras de señal aquí descritas sean utilizadas siempre solamente en combinación con la correspondiente documentación y solamente en combinación con el producto correspondiente. La utilización de las palabras de señal en combinación con productos o documentaciones que no les correspondan puede llevar a malinterpretaciones y tener por consecuencia daños en personas u objetos.

Informaciones de seguridad elementales

1. El producto solamente debe ser utilizado según lo indicado por el fabricante referente a la situación y posición de funcionamiento sin que se obstruya la ventilación. Si no se convino de otra manera, es para los productos R&S válido lo que sigue: como posición de funcionamiento se define principalmente la posición con el suelo de la caja para abajo , modo de protección IP 2X, grado de suciedad 2, categoría de sobrecarga eléctrica 2, utilizar solamente en estancias interiores, utilización hasta 2000 m sobre el nivel del mar.
A menos que se especifique otra cosa en la hoja de datos, se aplicará una tolerancia de $\pm 10\%$ sobre el voltaje nominal y de $\pm 5\%$ sobre la frecuencia nominal.
2. En todos los trabajos deberán ser tenidas en cuenta las normas locales de seguridad de trabajo y de prevención de accidentes. El producto solamente debe de ser abierto por personal périto autorizado. Antes de efectuar trabajos en el producto o abrirlo deberá este ser desconectado de la corriente. El ajuste, el cambio de partes, la manutención y la reparación deberán ser solamente efectuadas por electricistas autorizados por R&S. Si se reponen partes con importancia para los aspectos de seguridad (por ejemplo el enchufe, los transformadores o los fusibles), solamente podrán ser sustituidos por partes originales. Despues de cada recambio de partes elementales para la seguridad deberá ser efectuado un control de

Informaciones de seguridad

- seguridad (control a primera vista, control de conductor protector, medición de resistencia de aislamiento, medición de medición de la corriente conductora, control de funcionamiento).
3. Como en todo producto de fabricación industrial no puede ser excluido en general de que se produzcan al usarlo elementos que puedan generar alergias, los llamados elementos alergénicos (por ejemplo el níquel). Si se produjeran en el trato con productos R&S reacciones alérgicas, como por ejemplo urticaria, estornudos frecuentes, irritación de la conjuntiva o dificultades al respirar, se deberá consultar inmediatamente a un médico para averiguar los motivos de estas reacciones.
 4. Si productos / elementos de construcción son tratados fuera del funcionamiento definido de forma mecánica o térmica, pueden generarse elementos peligrosos (polvos de sustancia de metales pesados como por ejemplo plomo, berilio, níquel). La partición elemental del producto, como por ejemplo sucede en el tratamiento de materias residuales, debe de ser efectuada solamente por personal especializado para estos tratamientos. La partición elemental efectuada inadecuadamente puede generar daños para la salud. Se deben tener en cuenta las directivas nacionales referentes al tratamiento de materias residuales.
 5. En el caso de que se produjeran agentes de peligro o combustibles en la aplicación del producto que debieran de ser transferidos a un tratamiento de materias residuales, como por ejemplo agentes refrigerantes que deben ser repuestos en periodos definidos, o aceites para motores, deberán ser tenidas en cuenta las prescripciones de seguridad del fabricante de estos agentes de peligro o combustibles y las regulaciones regionales para el tratamiento de materias residuales. Cuiden también de tener en cuenta en caso dado las prescripciones de seguridad especiales en la descripción del producto.
 6. Ciertos productos, como por ejemplo las instalaciones de radiación HF, pueden a causa de su función natural, emitir una radiación electromagnética aumentada. En vista a la protección de la vida en desarrollo deberían ser protegidas personas embarazadas debidamente. También las personas con un bypass pueden correr peligro a causa de la radiación electromagnética. El empresario está comprometido a valorar y señalar áreas de trabajo en las que se corra un riesgo de exposición a radiaciones aumentadas de riesgo aumentado para evitar riesgos.
 7. La utilización de los productos requiere instrucciones especiales y una alta concentración en el manejo. Debe de ponerse por seguro de que las personas que manejen los productos estén a la altura de los requerimientos necesarios referente a sus aptitudes físicas, psíquicas y emocionales, ya que de otra manera no se pueden excluir lesiones o daños de objetos. El empresario lleva la responsabilidad de seleccionar el personal usuario apto para el manejo de los productos.
 8. Antes de la puesta en marcha del producto se deberá tener por seguro de que la tensión preseleccionada en el producto equivalga a la del la red de distribución. Si es necesario cambiar la preselección de la tensión también se deberán en caso dabo cambiar los fusibles correspondientes del producto.
 9. Productos de la clase de seguridad I con alimentación móvil y enchufe individual de producto solamente deberán ser conectados para el funcionamiento a tomas de corriente de contacto de seguridad y con conductor protector conectado.
 10. Queda prohibida toda clase de interrupción intencionada del conductor protector, tanto en la toma de corriente como en el mismo producto ya que puede tener como consecuencia el peligro de golpe de corriente por el producto. Si se utilizaran cables o enchufes de extensión se deberá poner al seguro, que es controlado su estado técnico de seguridad.
 11. Si el producto no está equipado con un interruptor para desconectarlo de la red, se deberá considerar el enchufe del cable de distribución como interruptor. En estos casos deberá asegurar de que el enchufe sea de fácil acceso y nabejo (medida del cable de distribución aproximadamente 2 m). Los interruptores de función o electrónicos no son aptos para el corte de la red eléctrica. Si los productos sin interruptor están integrados en construcciones o instalaciones, se deberá instalar el interruptor al nivel de la instalación.

Informaciones de seguridad

12. No utilice nunca el producto si está dañado el cable eléctrico. Asegure a través de las medidas de protección y de instalación adecuadas de que el cable de eléctrico no pueda ser dañado o de que nadie pueda ser dañado por él, por ejemplo al tropezar o por un golpe de corriente.
13. Solamente está permitido el funcionamiento en redes de distribución TN/TT aseguradas con fusibles de como máximo 16 A.
14. Nunca conecte el enchufe en tomas de corriente sucias o llenas de polvo. Introduzca el enchufe por completo y fuertemente en la toma de corriente. Si no tiene en consideración estas indicaciones se arriesga a que se originen chispas, fuego y/o heridas.
15. No sobrecargue las tomas de corriente, los cables de extensión o los enchufes de extensión ya que esto pudiera causar fuego o golpes de corriente.
16. En las mediciones en circuitos de corriente con una tensión de entrada de $U_{eff} > 30 \text{ V}$ se deberá tomar las precauciones debidas para impedir cualquier peligro (por ejemplo medios de medición adecuados, seguros, limitación de tensión, corte protector, aislamiento etc.).
17. En caso de conexión con aparatos de la técnica informática se deberá tener en cuenta que estos cumplan los requisitos de la EC950/EN60950.
18. Nunca abra la tapa o parte de ella si el producto está en funcionamiento. Esto pone a descubierto los cables y componentes eléctricos y puede causar heridas, fuego o daños en el producto.
19. Si un producto es instalado fijamente en un lugar, se deberá primero conectar el conductor protector fijo con el conductor protector del aparato antes de hacer cualquier otra conexión. La instalación y la conexión deberán ser efectuadas por un electricista especializado.
20. En caso de que los productos que son instalados fijamente en un lugar sean sin protector implementado, autointerruptor o similares objetos de protección, deberá la toma de corriente estar protegida de manera que los productos o los usuarios estén suficientemente protegidos.
21. Por favor, no introduzca ningún objeto que no esté destinado a ello en los orificios de la caja del aparato. No vierta nunca ninguna clase de líquidos sobre o en la caja. Esto puede producir corto circuitos en el producto y/o puede causar golpes de corriente, fuego o heridas.
22. Asegúrese con la protección adecuada de que no pueda originarse en el producto una sobrecarga por ejemplo a causa de una tormenta. Si no se verá el personal que lo utilice expuesto al peligro de un golpe de corriente.
23. Los productos R&S no están protegidos contra el agua si no es que exista otra indicación, ver también punto 1. Si no se tiene en cuenta esto se arriesga el peligro de golpe de corriente o de daños en el producto lo cual también puede llevar al peligro de personas.
24. No utilice el producto bajo condiciones en las que pueda producirse y se hayan producido líquidos de condensación en o dentro del producto como por ejemplo cuando se desplaza el producto de un lugar frío a un lugar caliente.
25. Por favor no cierre ninguna ranura u orificio del producto, ya que estas son necesarias para la ventilación e impiden que el producto se caliente demasiado. No pongan el producto encima de materiales blandos como por ejemplo sofás o alfombras o dentro de una caja cerrada, si esta no está suficientemente ventilada.
26. No ponga el producto sobre aparatos que produzcan calor, como por ejemplo radiadores o calentadores. La temperatura ambiental no debe superar la temperatura máxima especificada en la hoja de datos.

Informaciones de seguridad

27. Baterías y acumuladores no deben de ser expuestos a temperaturas altas o al fuego. Guardar baterías y acumuladores fuera del alcance de los niños. Si las baterías o los acumuladores no son cambiados con la debida atención existirá peligro de explosión (atención celulas de Litio). Cambiar las baterías o los acumuladores solamente por los del tipo R&S correspondiente (ver lista de piezas de recambio). Baterías y acumuladores son deshechos problemáticos. Por favor tirenlos en los recipientes especiales para este fin. Por favor tengan en cuenta las prescripciones nacionales de cada país referente al tratamiento de deshechos. Nunca sometan las baterías o acumuladores a un corto circuito.
28. Tengan en consideración de que en caso de un incendio pueden escaparse gases tóxicos del producto, que pueden causar daños a la salud.
29. Por favor tengan en cuenta que en caso de un incendio pueden desprenderse del producto agentes venenosos (gases, líquidos etc.) que pueden generar daños a la salud.
30. No sitúe el producto encima de superficies, vehículos, estantes o mesas, que por sus características de peso o de estabilidad no sean aptas para él. Siga siempre las instrucciones de instalación del fabricante cuando instale y asegure el producto en objetos o estructuras (por ejemplo paredes y estantes).
31. Las asas instaladas en los productos sirven solamente de ayuda para el manejo que solamente está previsto para personas. Por eso no está permitido utilizar las asas para la sujecion en o sobre medios de transporte como por ejemplo grúas, carretillas elevadoras de horquilla, carros etc. El usuario es responsable de que los productos sean sujetados de forma segura a los medios de transporte y de que las prescripciones de seguridad del fabricante de los medios de transporte sean tenidas en cuenta. En caso de que no se tengan en cuenta pueden causarse daños en personas y objetos.
32. Si llega a utilizar el producto dentro de un vehículo, queda en la responsabilidad absoluta del conductor que conducir el vehículo de manera segura. Asegure el producto dentro del vehículo debidamente para evitar en caso de un accidente las lesiones u otra clase de daños. No utilice nunca el producto dentro de un vehículo en movimiento si esto pudiera distraer al conductor. Siempre queda en la responsabilidad absoluta del conductor la seguridad del vehículo y el fabricante no asumirá ninguna clase de responsabilidad por accidentes o colisiones.
33. Dado el caso de que esté integrado un producto de laser en un producto R&S (por ejemplo CD/DVD-ROM) no utilice otras instalaciones o funciones que las descritas en la documentación. De otra manera pondrá en peligro su salud, ya que el rayo laser puede dañar irreversiblemente sus ojos. Nunca trate de descomponer estos productos. Nunca mire dentro del rayo laser.

Certified Quality System

DIN EN ISO 9001 : 2000
DIN EN 9100 : 2003
DIN EN ISO 14001 : 1996

DQS REG. NO 001954 QM/ST UM

QUALITÄTSZERTIFIKAT

Sehr geehrter Kunde,

Sie haben sich für den Kauf eines Rohde & Schwarz-Produktes entschieden. Hiermit erhalten Sie ein nach modernsten Fertigungsmethoden hergestelltes Produkt. Es wurde nach den Regeln unseres Managementsystems entwickelt, gefertigt und geprüft.

Das Rohde & Schwarz Managementsystem ist zertifiziert nach:

DIN EN ISO 9001:2000
DIN EN 9100:2003
DIN EN ISO 14001:1996

CERTIFICATE OF QUALITY

Dear Customer,

you have decided to buy a Rohde & Schwarz product. You are thus assured of receiving a product that is manufactured using the most modern methods available. This product was developed, manufactured and tested in compliance with our quality management system standards.

The Rohde & Schwarz quality management system is certified according to:

DIN EN ISO 9001:2000
DIN EN 9100:2003
DIN EN ISO 14001:1996

CERTIFICAT DE QUALITÉ

Cher Client,

vous avez choisi d'acheter un produit Rohde & Schwarz. Vous disposez donc d'un produit fabriqué d'après les méthodes les plus avancées. Le développement, la fabrication et les tests respectent nos normes de gestion qualité.

Le système de gestion qualité de Rohde & Schwarz a été homologué conformément aux normes:

DIN EN ISO 9001:2000
DIN EN 9100:2003
DIN EN ISO 14001:1996



ROHDE & SCHWARZ

Customer Support

Technical support – where and when you need it

For quick, expert help with any Rohde & Schwarz equipment, contact one of our Customer Support Centers. A team of highly qualified engineers provides telephone support and will work with you to find a solution to your query on any aspect of the operation, programming or applications of Rohde & Schwarz equipment.

Up-to-date information and upgrades

To keep your Rohde & Schwarz equipment always up-to-date, please subscribe to our electronic newsletter at

<http://www.rohde-schwarz.com/www/response.nsf/newsletterpreselection>

or request the desired information and upgrades via email from your Customer Support Center (addresses see below).

Feedback

We want to know if we are meeting your support needs. If you have any comments please email us and let us know CustomerSupport.Feedback@rohde-schwarz.com.

USA & Canada

Monday to Friday (except US public holidays)

8:00 AM – 8:00 PM Eastern Standard Time (EST)

Tel. from USA 888-test-rsa (888-837-8772) (opt 2)

From outside USA +1 410 910 7800 (opt 2)

Fax +1 410 910 7801

E-mail Customer.Support@rsa.rohde-schwarz.com

East Asia

Monday to Friday (except Singaporean public holidays)

8:30 AM – 6:00 PM Singapore Time (SGT)

Tel. +65 6 513 0488

Fax +65 6 846 1090

E-mail Customersupport.asia@rohde-schwarz.com

Rest of the World

Monday to Friday (except German public holidays)

08:00 – 17:00 Central European Time (CET)

Tel. from Europe +49 (0) 180 512 42 42

From outside Europe +49 89 4129 13776

Fax +49 (0) 89 41 29 637 78

E-mail CustomerSupport@rohde-schwarz.com



Contents of Manuals for EMI Test Receiver R&S ESCI

Operating Manual R&S ESCI

The operating manual describes the following models and options of EMI test receiver ESCI:

- R&S ESCI
- Option FSP-B4 OCXO - reference oscillator
- Option FSP-B6 TV trigger
- Option FSP-B9 tracking generator
- Option FSP-B10 external generator control
- Option FSP-B16 LAN interface

This operating manual contains information about the technical data of the instrument, the setup functions and about how to put the instrument into operation. It informs about the operating concept and controls as well as about the operation of the R&S ESCI via the menus and via remote control. Typical measurement tasks for the R&S ESCI are explained using the functions offered by the menus and a selection of program examples.

Additionally the operating manual includes information about maintenance of the instrument and about error detection listing the error messages which may be output by the instrument. It is subdivided into the data sheet plus 9 chapters:

The data sheet	informs about guaranteed specifications and characteristics of the instrument.
Chapter 1	describes the control elements and connectors on the front and rear panel as well as all procedures required for putting the R&S ESCI into operation and integration into a test system.
Chapter 2	gives an introduction to typical measurement tasks of the R&S ESCI which are explained step by step.
Chapter 3	describes the operating principles, the structure of the graphical interface and offers a menu overview.
Chapter 4	forms a reference for manual control of the R&S ESCI and contains a detailed description of all instrument functions and their application. The chapter also lists the remote control command corresponding to each instrument function.
Chapter 5	describes the basics for programming the R&S ESCI, command processing and the status reporting system.
Chapter 6	lists all the remote-control commands defined for the instrument. At the end of the chapter a alphabetical list of commands and a table of softkeys with command assignment is given.
Chapter 7	contains program examples for a number of typical applications of the R&S ESCI.
Chapter 8	describes preventive maintenance and the characteristics of the instrument's interfaces.
Chapter 8	gives a list of error messages that the R&S ESCI may generate.
Chapter 9	contains a list of error messages.
Chapter 10	contains an index for the operating manual.

Service Manual - Instrument

The service manual - instrument informs on how to check compliance with rated specifications, on instrument function, repair, troubleshooting and fault elimination. It contains all information required for the maintenance of R&S ESCI by exchanging modules.

Contents - Chapter 1 " Preparing for Operation "

1 Preparing for Operation	1.1
Description of Front and Rear Panel Views	1.1
Front View	1.1
Rear View	1.9
Getting Started with the Instrument	1.12
Preparing the Instrument for Operation.....	1.12
Setting Up the Instrument.....	1.12
Standalone Operation	1.12
Safety Instruction for Instruments with Tilttable Feet	1.13
Rackmounting	1.13
EMC Safety Precautions	1.14
Connecting the Instrument to the AC Supply	1.14
Switching the Instrument On/Off	1.14
Switching On the Instrument.....	1.15
Startup Menu and Booting	1.15
Switching Off the R&S ESCI	1.15
Power-Save Mode.....	1.16
Recalling the Most Recent Instrument Settings	1.16
Function Test	1.16
Windows XP	1.17
Connecting an External Keyboard	1.18
Connecting a Mouse	1.19
Connecting an External Monitor	1.20
Connecting a Printer	1.21
Selecting a Printer	1.21
Installation of Plug&Play Printers	1.24
Installation of Non-Plug&Play Printers.....	1.24
Local Printer	1.26
Configuring a Network Printer	1.30
Connection of USB Devices	1.32
Installing Windows XP Software	1.34
Authorized Windows XP Software for the Instrument	1.34

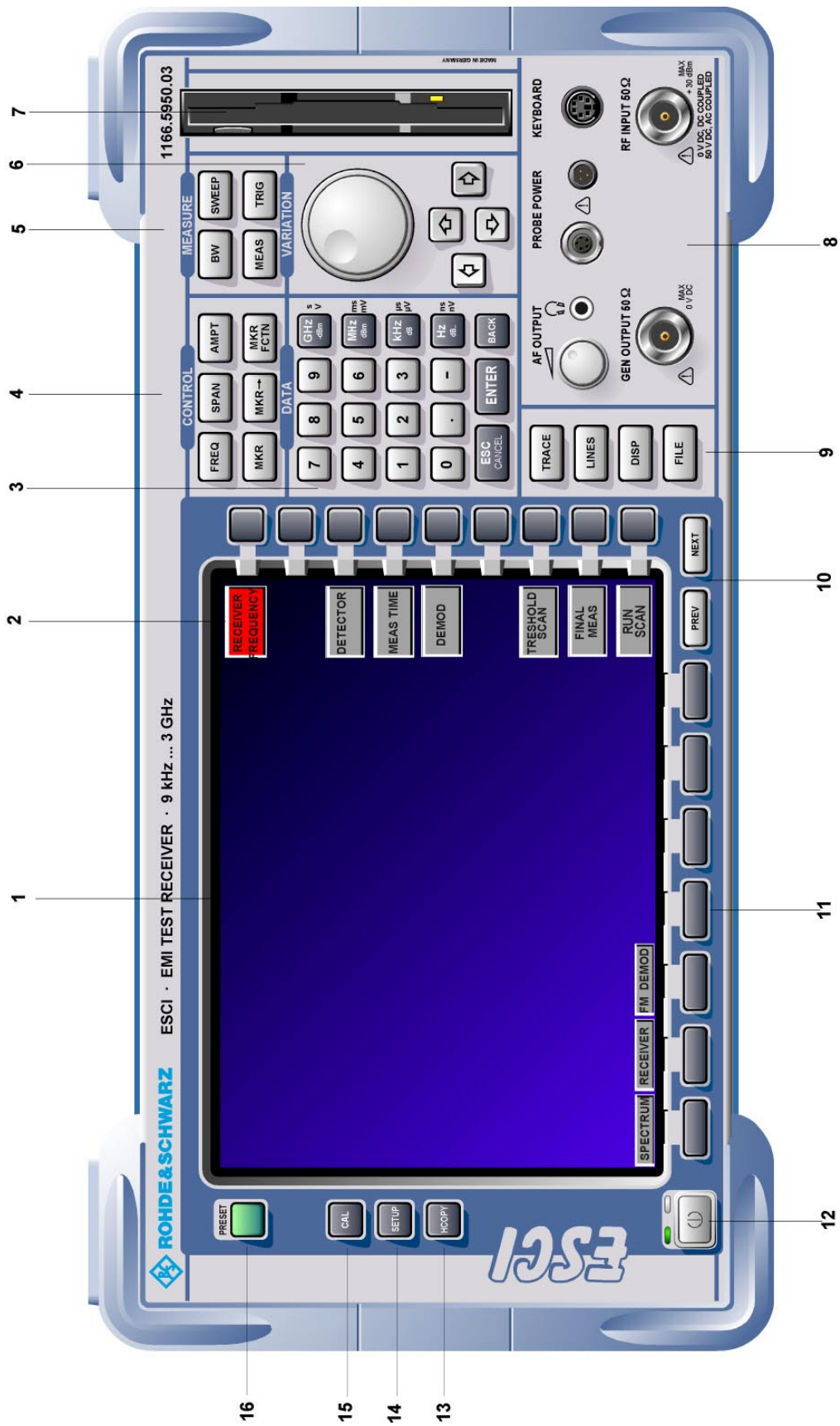

Fig. 1-1 Front View

1 Preparing for Operation

Chapter 1 describes the controls and connectors of the test receiver R&S ESCI by means of the front and rear view. Then follows all the information that is necessary to put the instrument into operation and connect it to the AC supply and to external devices.

A more detailed description of the hardware connectors and interfaces can be found in chapter 8. Chapter 2 provides an introduction into the operation of the R&S ESCI by means of typical examples of configuration and measurement; for the description of the concept for manual operation and an overview of menus refer to chapter 3.

For a systematic explanation of all menus, functions and parameters and background information refer to the reference part in chapter 4.

For remote control of the R&S ESCI refer to the general description of the SCPI commands, the instrument model, the status reporting system, and command description in chapter 5 and 6.

Description of Front and Rear Panel Views

Front View

1

Display Screen

|| see Chapter 3

2

Softkeys

|| see Chapter 3

3



data input

- 0...9 input numbers
- . input decimal point
- change sign
- ESC – close input field (for uncompleted or already closed inputs, the original entry is kept)
- CANCEL – erase the current entry in input field (beginning of an input)
- close message window (status, error and warning messages)
- ENTER close the data input.
- BACK – erase last character input for uncompleted input
- restore previous input (undo)

|| see Chapter 3

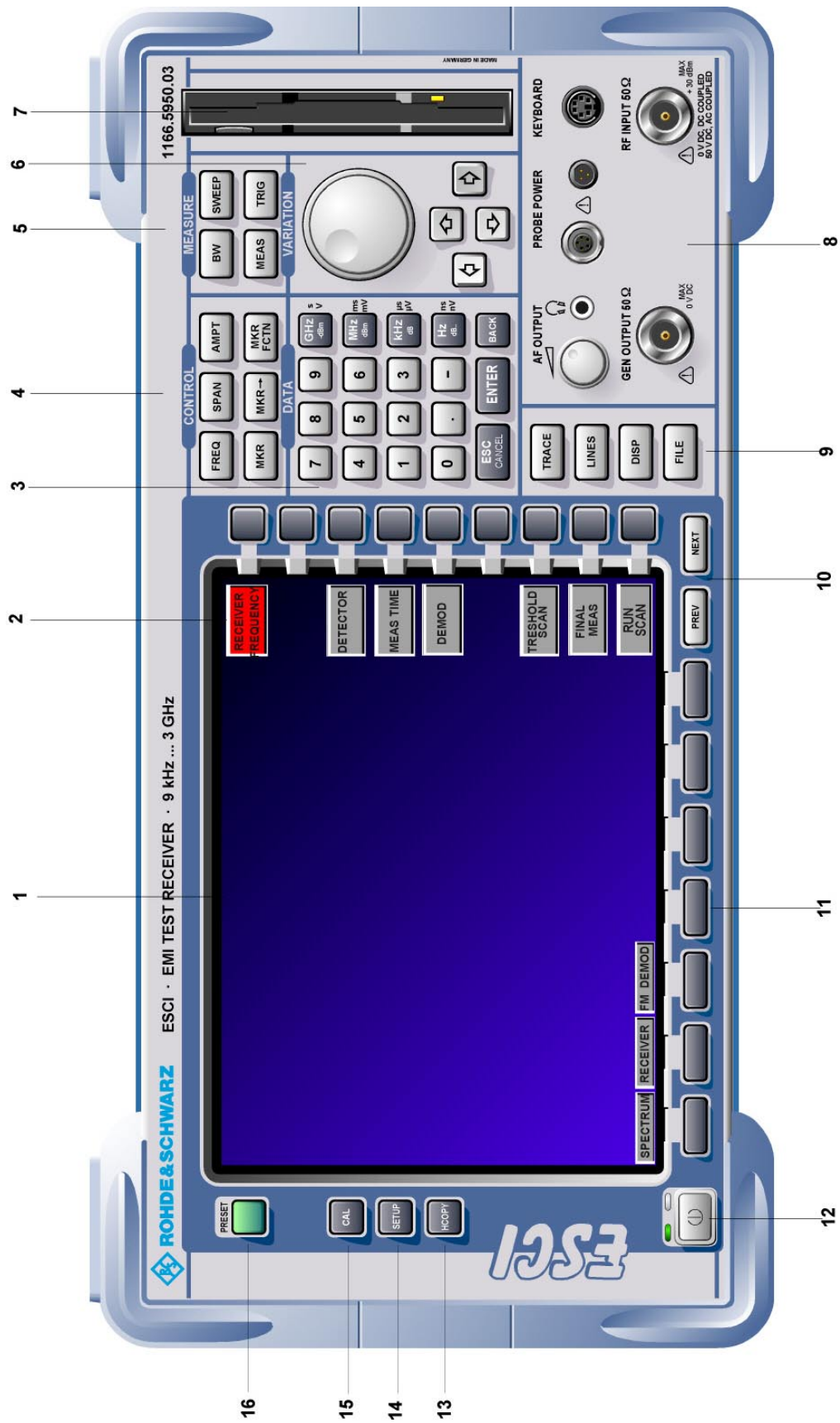

Fig. 1-1 Front View



Keypad for data input

- GHz s The units keys close the data
- dBm V input and define the multipli-
- cation factor for each basic unit.
- MHz ms For dimension-less or
- dBm mV alphanumeric inputs, the units
- keys have weight 1.
- kHz μ s They behave, in this case, like the
- dB μ V ENTER key.
- Hz ns
- dB.. nV

see Chapter 3

4



- FREQ Set frequency axis
- SPAN Set span
- AMPT Set level indication and configure
- RF input.
- MKR Select and set standard marker and delta
- marker functions.
- MKR-> Change instrument settings via markers
- MKR Select further marker and delta
- FCTN marker functions

see Chapter 4

5



- BW –Set resolution bandwidth, video
- bandwidth and sweep time,
- Set coupling of these parameters
- SWEEP Select sweep or set scan parameters
- MEAS Select and set power measurements or
- select detectors and measurement time
- TRIG Set trigger sources

see Chapter 4

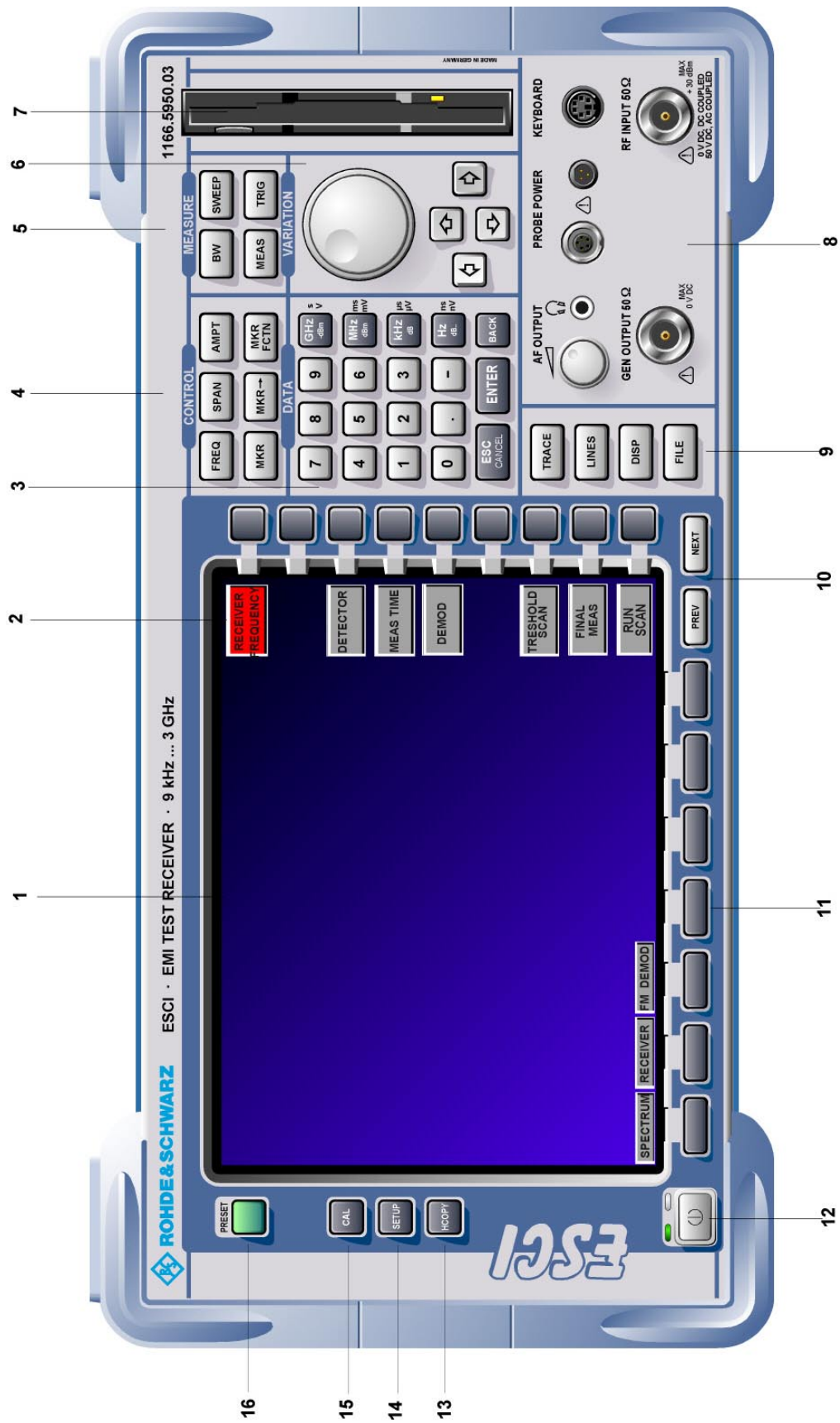
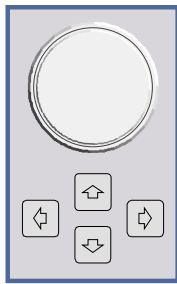

Fig. 1-1 Front View

6



- Key group for entering data and for cursor movement
- Cursor keys – Move the cursor within the input fields and tables.
 – Vary the input value.
 – Define the direction of movement for the roll-key.
- Roll-key – Vary input values.
 – Move markers and limits.
 – Select letters in the help line editor.
 – Move cursor in the tables
 – Close data input (ENTER)



see Chapter 3

7

3 1/2" diskette drive; 1.44 MByte

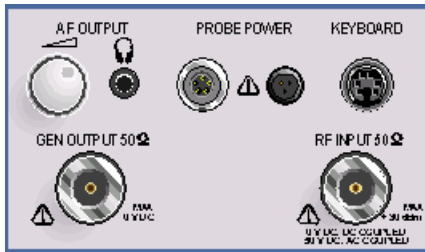
8



- AF OUTPUT
 Volume control
 Head phone connector
- PROBE POWER Power supply and coded socket (+15 V/ -12 V) for accessories
- KEYBOARD Connector for an external keyboard
- GEN OUTPUT Generator output (option FSP-B9)
- RF INPUT RF input

see Chapter 8



Caution:
 For DC-coupling, the max. DC voltage is 0 V. For AC-coupling, the max. DC voltage is 50 V. The maximum power is 1 W (30 dBm at ≥ 30 dB attenuation)

see Chapter 8

9



- TRACE Select and activate traces and detectors
- LINES Set limit lines
- DISP Configure display
- FILE – Save and recall instrument data
 – Configuration of memory media and data

see Chapter 4

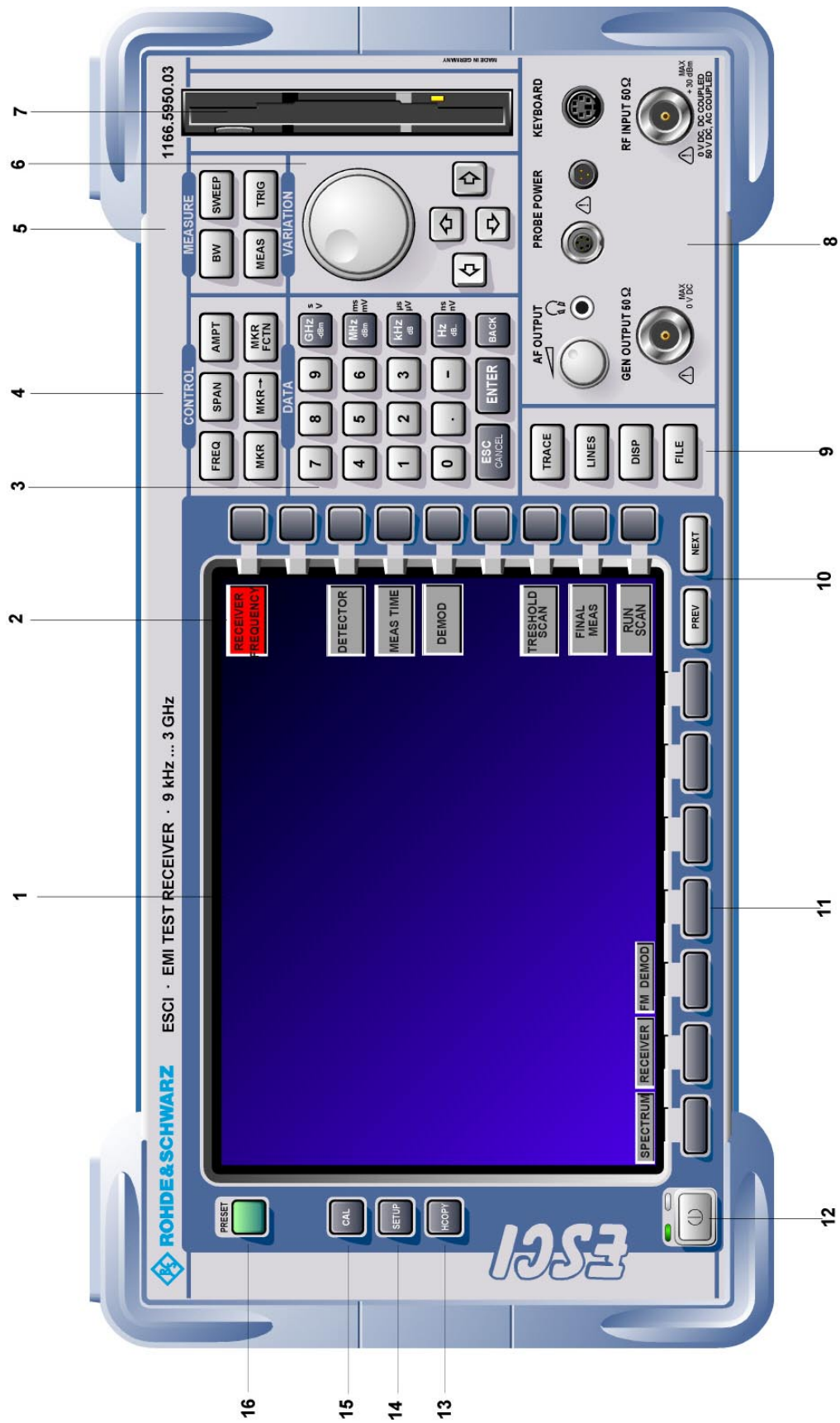



Fig. 1-1 Front View

10

	Menu-change keys NEXT Change to side menu PREV Call main menu	see Chapter 3
---	---	---------------

11

Hotkeys	see Chapter 3
---------	---------------

12

	ON/STANDBY switch	see Chapter 1
---	-------------------	---------------

13

	Configure and start a print job	see Chapters 1 and 4
---	---------------------------------	----------------------

14

	Define general configuration	see Chapter 4
---	------------------------------	---------------

15

	Record correction data	see Chapter 4
---	------------------------	---------------

16

	Call default settings	see Chapter 4
---	-----------------------	---------------

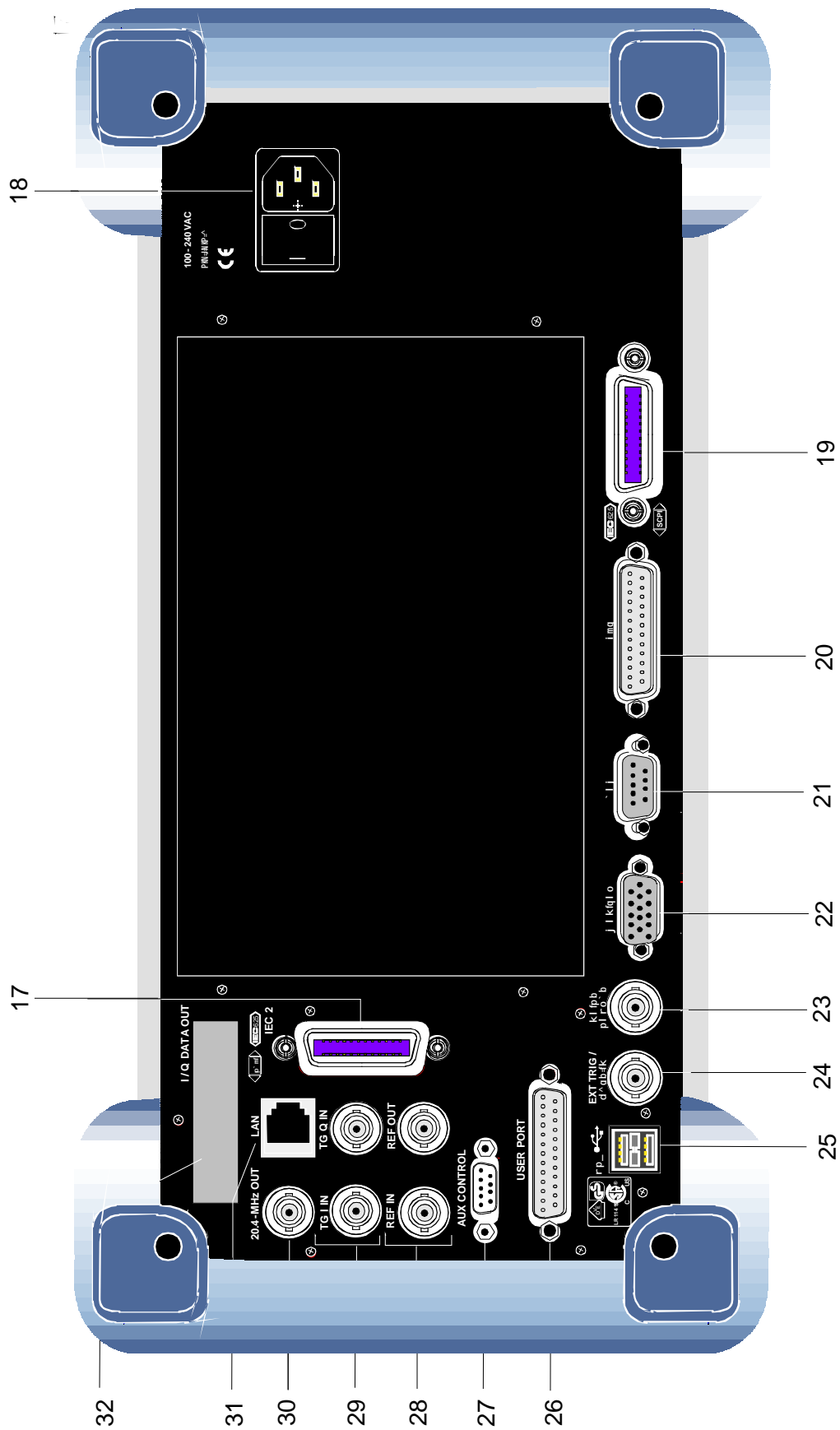

Fig. 1-2 Rear View

Rear View

17

IEC/IEEE bus-connector 2 for the external generator (with Option R&S FSP-B10 only)

see Chapter 8

18

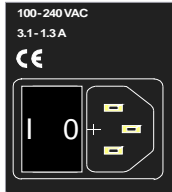

Power switch and AC power connector

see Chapter 1

19

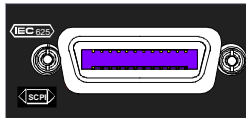

IEC/IEEE bus-connector

see Chapter 8

20

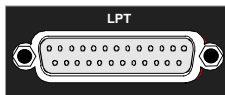

Parallel interface connector (printer connector)

see Chapter 8

21



Connector for a serial interface (9-pin socket; COM)

see Chapter 8

22



Connector for an external monitor

see Chapter 8

23



Output connector for an external noise source

see Chapter 8

24



Input connector for an external trigger or an external gate signal

see Chapter 8

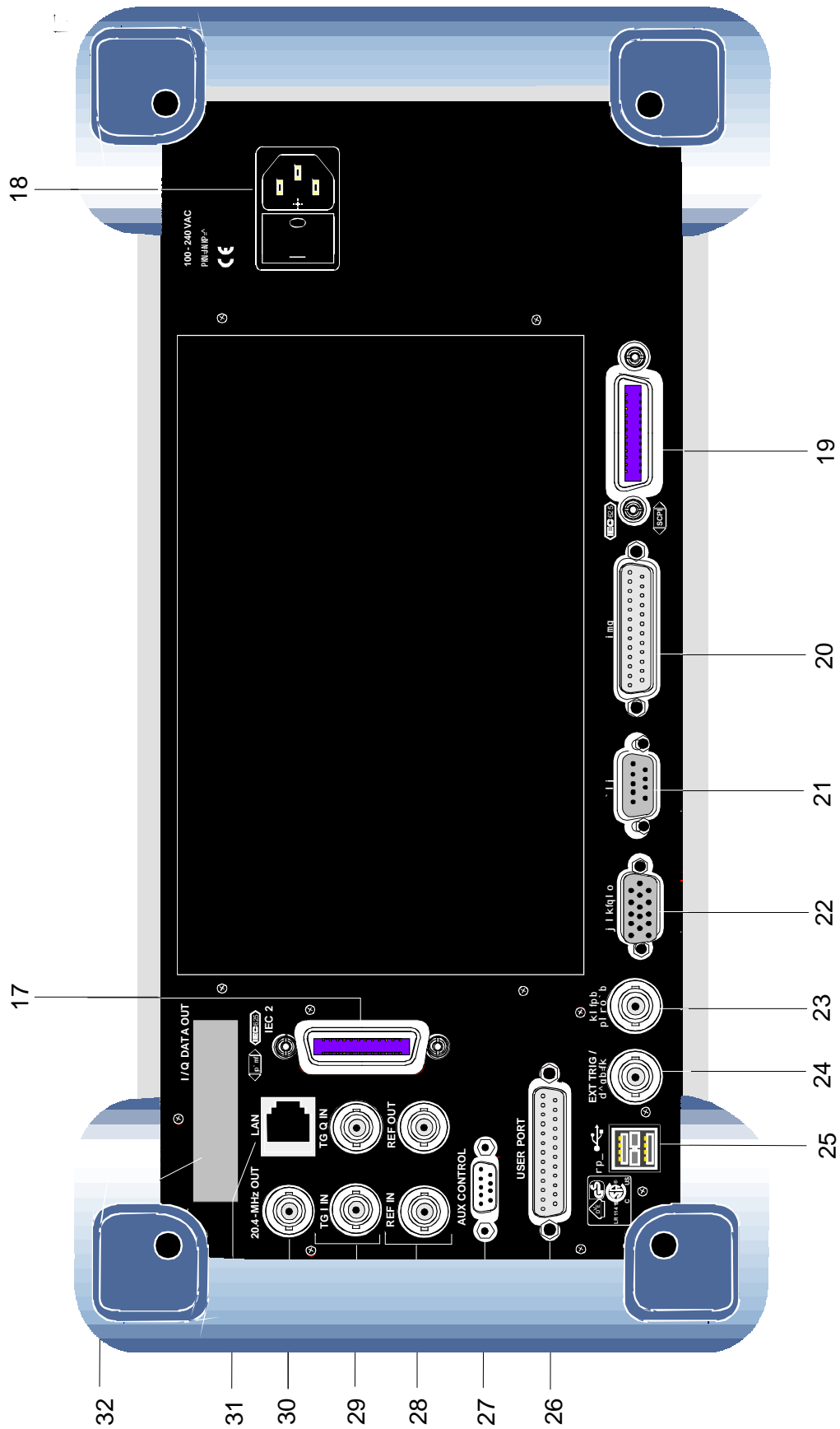

Fig. 1-2 Rear View

25



USB interface

see Chapter 8

26

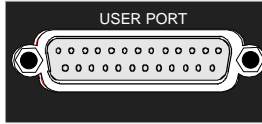

USER PORT Output/input. TTL levels
(Low < 0,4 V, High > 2 V).
Internal +5 V power supply voltage.
Maximum load current 100 mA.

see Chapter 8

27



AUX Control connector for controlling the external
generator (option R&S FSP-B10 only)

28

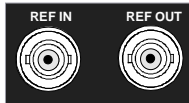

REF IN Input connector for an external
reference (10 MHz)

REF OUT Output connector for an internal
reference (10 MHz)

29

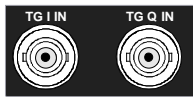

TG I IN Input connector for external modulation
of tracking generator (option FSP-B9)

TG Q IN Input connector for external modulation
of tracking generator (option FSP-B9)

see Chapter 4

30



Output connector for 20.4 MHz IF
(not if option FSP-B6 is built in)

see Chapter 8



Selectable CCVS input/output
(only if option FSP-B6 is built in)

see Chapter 4 and 8

31



LAN Interface (FSP-B16)

see Chapter 4

32

Reserved for options

Getting Started with the Instrument

The following section describes how to activate the instrument and how to connect external devices such as printer and monitor.

Chapter 2 explains the operation of the instrument using simple measurement examples.



Important:

Prior to switching on the instrument, make sure that the following conditions are fulfilled:

- *The instrument cover is in place and tightly screwed on*
- *Fan openings are not obstructed*
- *Signal levels at the inputs are within specified limits*
- *Signal outputs are connected correctly and not overloaded.*

Any non-compliance may cause damage to the instrument .

Preparing the Instrument for Operation

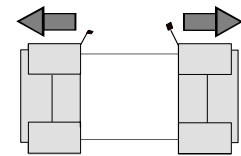

remove protective caps

- Take the instrument out of the packaging and check whether the items listed in the packing list and in the lists of accessories are all included.
- Remove the two protective covers from the front and rear of the R&S ESCI and carefully check the instrument for damage.
- Should the instrument be damaged, immediately notify the carrier and keep the box and packing material.
- For further transport or shipment of the R&S ESCI, the original packing should be used. It is recommended to keep at least the two protective covers of the front and rear panels in order to prevent damage to the controls and connectors.

Setting Up the Instrument

Standalone Operation

The instrument is designed for use under general laboratory conditions. The ambient conditions required at the site of operation are as follows:

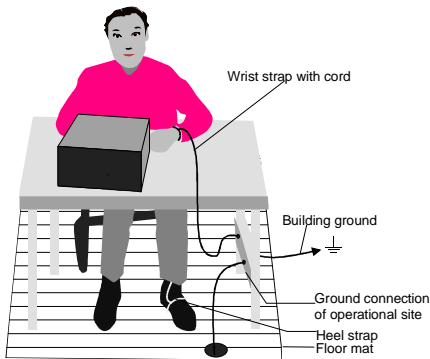

- The ambient temperature must be in the range specified in the data sheet.
- All fan openings must be unobstructed and the air flow at the rear panel and at the side-panel perforations must be unimpeded. The distance to the wall should be at least 10 cm.
- The mounting surface should be flat.
- To avoid damage of electronic components of the DUT due to electrostatic discharge on manual touch, protective measures against electrostatic discharge are recommended.

Safety Instruction for Instruments with Tilttable Feet



Warning

The feet must be fully folded in or out. Only in this way can the stability of the instrument be guaranteed and reliable operation be ensured. With the feet out, the total load for the feet must not exceed 500 N (own weight and additional units put onto the instrument). These units must be secured against slipping (e.g. by locking the feet of the unit at the top side of the enclosure).

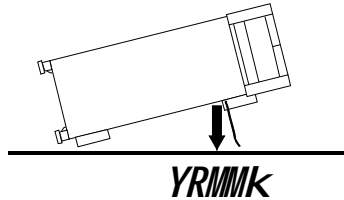

When shifting the instrument with the feet out, the feet might collapse and fold in. To avoid injuries, the instrument must therefore not be shifted with the feet out.

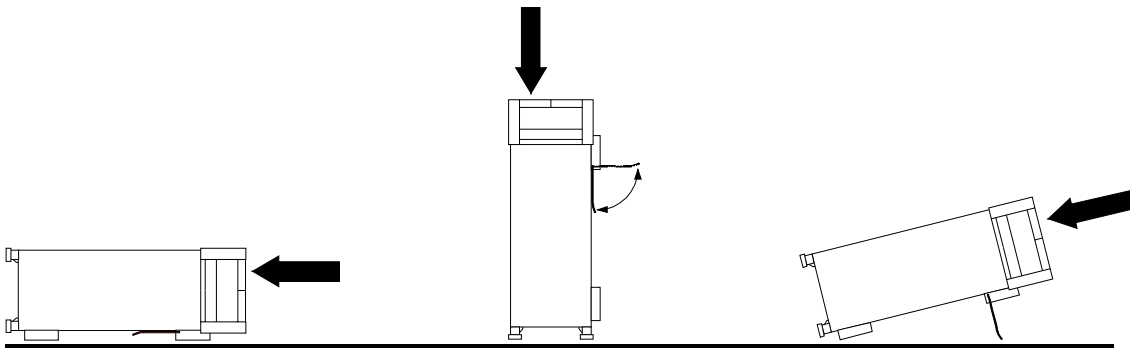

The instrument can be operated in any position.

Rackmounting



Important:

For rack installation, ensure that the air flow at the side-panel perforations and the air exhaust at the rear panel are not obstructed.

The instrument may be installed in a 19" rack by using a rack adapter kit (Order No. see data sheet). The installation instructions are part of the adapter kit.

EMC Safety Precautions

In order to avoid electromagnetic interference (EMI), the instrument may be operated only with all covers closed. Only adequately shielded signal and control cables may be used (see recommended accessories).

Connecting the Instrument to the AC Supply

The R&S ESCI is equipped with an AC voltage selection feature and will automatically adapt itself to the applied AC voltage (range: 100 to 240 V AC, 40 to 400 Hz). External voltage selection or adaptation of the fuses are not necessary. The AC power connector is located on the rear panel (see below).

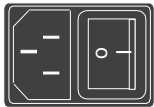

Power connector

- Connect the instrument to the AC power source using the AC power cable delivered with the instrument.

As the instrument is designed according to the regulations for safety class EN61010, it must be connected to a power outlet with earthing contact.

Switching the Instrument On/Off



Caution:

Do not power down during booting. Such a switch-off may lead to corruption of the hard disk files.

AC power switch on the rear panel

Power switch Power connector

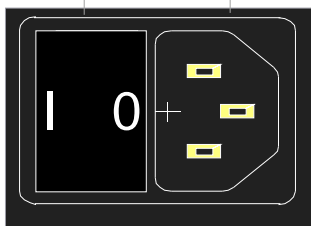

Power switch

Position I = ON

In the I position, the instrument is in standby mode or in operation, depending on the position of the ON/STANDBY key at the front of the instrument.

Note:

The AC power switch may remain ON continuously. Switching to OFF is only required when the instrument must be completely removed from the AC power source.

Position 0 = OFF

The 0 position implies an all-pole disconnection of the instrument from the AC power source.

ON/STANDBY switch on the front panel

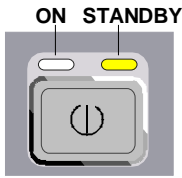

Caution:

In standby mode, the AC power voltage is present within the instrument

Standby switch

The ON/STANDBY switch activates two different operating modes indicated by coloured LEDs:

Operation ON - ON/STANDBY is depressed

The green LED (ON) is illuminated. The instrument is ready for operation. All modules within the instrument are supplied with power.

STANDBY - ON/STANDBY switch is not pressed.

The yellow LED (STANDBY) is illuminated. Only the power supply is supplied with power and the quartz oven is maintained at normal operating temperature.

Switching On the Instrument

- In order to switch on the R&S ESCI, set the power switch on the rear panel to position I.
- Set the R&S ESCI to operating mode by pressing the *ON/STANDBY* key on the front panel. The green LED must be illuminated.

Startup Menu and Booting

After switching on the instrument, a message indicating the installed BIOS version (e.g. Analyzer BIOS Rev. 1.2) appears on the screen for a few seconds.

Subsequently Windows XP is booted first and after that the instrument firmware will boot. As soon as the boot process is finished the instrument will start measuring. The settings used will be the one that was active when the instrument was previously switched off, provided no other device configuration than *FACTORY* had been selected with *STARTUP RECALL* in the *FILE* menu.

Switching Off the R&S ESCI

- Switch the ON/STANDBY key on the front panel to standby mode by pressing it once.
The R&S ESCI will write the current instrument settings to disk before performing a Windows XP shutdown. At the end of the shutdown procedure the power supply will be switched to STANDBY mode.
The yellow LED must be illuminated.

Only when removing the R&S ESCI completely from the AC power source:

- Set the power switch at the rear panel to position 0.

Power-Save Mode

Display:

The R&S ESCI offers the possibility of switching on a power-save mode for the screen display. The backlighting will be switched off if no entry is made on the front panel (key, softkey or hotkey as well as spinwheel) during the selected response time.

In order to switch on the power-save mode:

1. Call the *DISPLAY - CONFIG DISPLAY* submenu to configure the screen display:
 - Press *DISP* key
 - Press *CONFIG DISPLAY* softkey
2. Activate the save mode
 - Press *DISPLAY PWR SAVE* softkey.
The softkey is highlighted in colour, thus indicating that the power-save mode is on. At the same time the data entry for the delay time is opened.
3. Define the delay time
 - Enter the required response time in minutes and confirm the entry using the *ENTER* key.
The screen will be blanked out after the selected time period has elapsed.

Hard disk:

A power-save mode is preset for the built-in hard disk which is automatically closed down 15 minutes after the last access.

Recalling the Most Recent Instrument Settings

The R&S ESCI stores its current instrument settings onto the hard disk every time it is switched off via the ON/STANDBY key. After each power-on, the R&S ESCI is reloaded with the operational parameters which were active just prior to the last power-off (STANDBY or AC power OFF) or were set with STARTUP RECALL (see Chapter 4 "Saving and Recalling Data Sets").

Note: *Storing the current instrument settings is not possible if the instrument is switched off using the POWER ON switch at the rear panel or when unplugging the mains cord. After power-on the instrument settings stored previously on the hard disk will be loaded in this case.*

Function Test

After turning on the AC power, the R&S ESCI will display the following message on the display screen:

Rohde & Schwarz GmbH & Co. KG
Analyzer BIOS Vx.y

After appearance of the above message, a selftest of the controller hardware is performed. Subsequently, the Windows XP controller boots and the measurement screen will appear.

The system self-alignment is activated via *CAL* key, *CAL TOTAL* softkey. The individual results of the self-alignment (PASSED / FAILED) can be displayed in the *CAL* menu (*CAL RESULTS*). With the aid of the built-in selftest functions (*SETUP* key, *SERVICE*, *SELFTEST* soft keys), the functional integrity of the instrument can be verified and/or defective modules can be localized.

Windows XP

**Caution:**

The drivers and programs used under Windows XP are adapted to the measuring instrument. In order to prevent the instrument functions from damage, the settings should only be modified as described below.

Existing software may only be modified using update software released by Rohde & Schwarz.

Additionally only programs authorized by Rohde & Schwarz for use on the R&S ESCI may be run on the instrument.

Do not power down during booting. *Such a switch-off may lead to corruption of the hard disk files.*

The instrument runs under the operating system Windows XP Embedded. The computer can be used to install and configure device drivers that were authorized by Rohde & Schwarz. Any further use of the computer function is only allowed under the conditions described in this operating manual.

Login

Windows XP requires a login process, during which the user is asked for identification by entering his name and password. As a factory default the instrument is configured for *Auto Login*, i.e. the login is performed automatically and in the background. The user name used for this is "instrument" and the password is also "instrument" (in small letters).

Administrator level

The NT user account used for the autologin function has administrator access rights.

Windows XP Service Packs

The Windows XP Embedded system installed on the instrument includes Service Pack 1 for XP Embedded.

Any service pack not approved by Rohde & Schwarz must not be installed since malfunctions may occur. These malfunctions could impair measurements that are correctly performed on the instrument and necessitate a repair.

The user is especially warned against using Service Packs of Windows XP Home or of the Professional Edition, since these Service Packs are not compatible with Windows XP Embedded.

Calling the Windows XP start menu

The Windows XP start menu is called using the key combination <CTRL> <ESC>. It is possible to access the required submenus from the start menu by means of the mouse or the cursor keys. In order to return to the measurement screen the button "R&S Analyzer Interface" in the Windows XP task bar can be used.

Connecting an External Keyboard

**Caution:**

Connect the keyboard only when the instrument is switched off (STANDBY). Otherwise, proper functioning cannot be ensured due to interactions with the firmware.

The R&S ESCI allows an external PC keyboard to be connected to the 6-pin PS/2 connector labelled KEYBOARD on the front panel or to the USB interface on the rear panel.

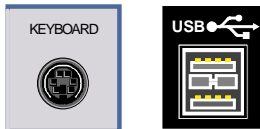

The keyboard makes it easier to enter comments, file names, etc, when measurements are performed.

If the keyboard is to be connected to the PS/2 connector, the PSP-Z2 keyboard (Order No. 1091.4100.02, English) is recommended. This keyboard includes not only the PC keyboard but also a trackball for controlling the mouse.

Keyboards and mouse devices in line with the USB standard 1.1 are suitable for connection to the USB interface.

The keyboard (except for PSP-Z2, see above) will automatically be recognized after connection. The US keyboard assignment is the default setting. Special settings such as refresh rate can be performed in the Windows XP menu START - SETTINGS - CONTROL PANEL - KEYBOARD.

Chapter 8 contains the interface description for the connectors.

Connecting a Mouse

To make Windows XP operation easier, the R&S ESCI allows a mouse to be connected to the USB interface on the rear panel.



Microsoft and Logitech mouse types are supported.

Note. *The recommended keyboard PSP-Z2 is equipped with a trackball for mouse control. Connecting an additional mouse will cause interface conflicts and lead to malfunctions of the instrument.*

After connection the mouse is automatically recognized. Special settings such as mouse cursor speed etc, can be performed in the Windows XP menu START - SETTINGS - CONTROL PANEL - MOUSE. Chapter 8 contains the interface description for the connector.

Connecting an External Monitor

**Caution:**

The monitor may only be connected when the instrument is switched off (STANDBY). Otherwise, the monitor may be damaged.

Do not modify the screen driver (display type) and display configuration since this will severely affect instrument operation.

The instrument is equipped with a rear-panel MONITOR connector for the connection of an external monitor.

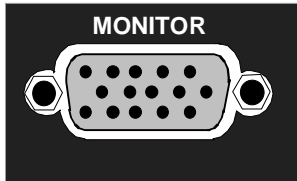

After connecting the external monitor the instrument needs to be rebooted in order to recognize the monitor. After that the measurement screen is displayed on both the external monitor and the instrument. Further settings are not necessary.

Connecting a Printer

A printer can be connected while the instrument is running.

The R&S ESCI allows two different printer configurations for printing a hardcopy to be created plus switchover between these two configurations. The *DEVICES* table in the *HCOPY* menu shows the available selection of installed printers (see section 4.4 "Documentation of Measurement Results").

The interfaces for connecting printers are on the rear panel:

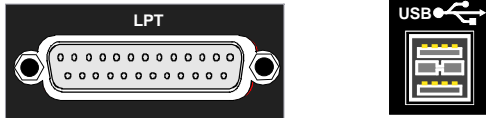

Chapter 8 contains the interface description for the connectors.

Selecting a Printer

Before a hardcopy can be printed, the printer has to be selected from the "*HCOPY*" menu.

In the following example, an HP DeskJet 660C printer that was preinstalled for LPT1 is selected as *DEVICE2* for hardcopies of the screen content.

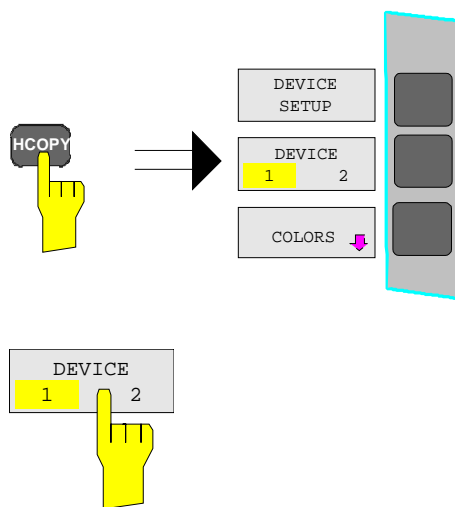

-
- Press the *HCOPY* key.
- The *HCOPY* menu will open.

-
- Press the *DEVICE 1/2* softkey.
- Device 2 will become the active output unit.

Note:

If the printer is to be operated as device 1, this step can be omitted.

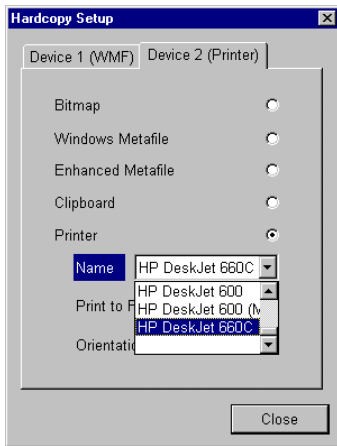
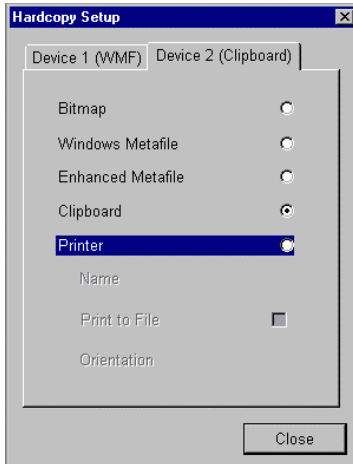
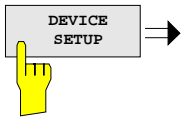

- Press the *DEVICE SETUP* softkey.

The *HARDCOPY SETUP* table opens and displays the selection of output formats. The current selection "*Clipboard*" is highlighted and marked with a dot in the option button.

- Use the cursor key to move the selection bar to "*Printer*" and press *ENTER*.

Windows for selecting a printer (Name), printing to file (Print to File) and selecting printout orientation (Orientation) are displayed.

- Use the cursor key to set the selection bar to "*Name*" and press *ENTER*.

The list of available printer types appears.

- Use the cursor key / or the spinwheel to move the selection bar to the "HP DeskJet 660C" printer and press *ENTER*.

The list closes and the selected printer appears in the "Name" field.

Note:

If the desired printer is not available in the selection list, its driver must first be installed.

For further information, see sections "Installation of Plug&Play Printers", "Installation of Non-Plug&Play Printers" and "Installation of Network Printers".

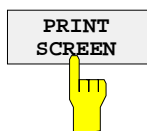
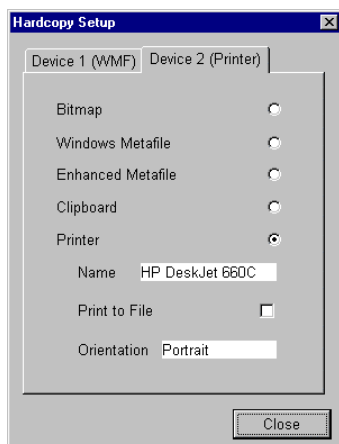
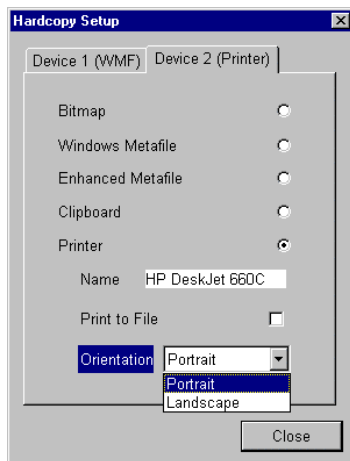
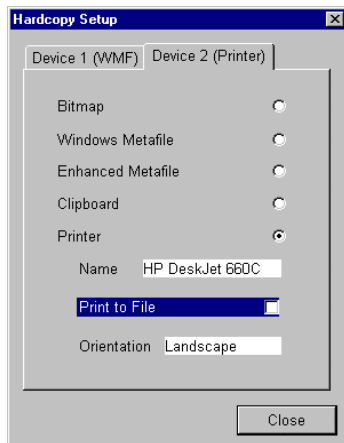



- Press the cursor key  or turn the spinwheel until the "Close" button is reached.

Further settings can still be made:

"Print to File" redirects printing to a file. In this case, the system prompts you for a file name when printing is started.

- The selection is activated by pressing *ENTER* or the spinwheel.

"Orientation" is used to switch between portrait and landscape format.

- To change the selection, open the list by pressing *ENTER* and select the desired orientation with the cursor key  / . To close the list, press *ENTER* again.

The "Close" button is used to complete the setup.

- Press *ENTER* as soon as the "Close" button is available.

The dialog closes. Printing will now be performed according to the selected settings.

Start printing

- Press the *PRINT SCREEN* softkey.

A hardcopy of the screen contents will be printed.

The factory setting for DEVICE 2 is "Clipboard". In this case, the printout will be copied to the Windows XP clipboard which is supported by most Windows applications. The contents of the clipboard can be pasted directly into a document via EDIT - PASTE.

Table 1-1 Factory settings for *DEVICE 1* and *DEVICE 2* in the *HCOPY* menu shows the factory settings for the two output devices.

Table 1-1 Factory settings for *DEVICE 1* and *DEVICE 2* in the *HCOPY* menu

Setting	Selection in configuration table	Setting for <i>DEVICE 1</i>	Setting for <i>DEVICE 2</i>
Output device	DEVICE	WINDOWS METAFILE	CLIPBOARD
Output	PRINT TO FILE	YES	---
Orientation	ORIENTATION	---	---

Installation of Plug&Play Printers

The installation of Plug&Play printers under Windows XP is quite simple:

After the printer is connected and switched on, Windows XP automatically recognizes it and installs its driver, provided the driver is included in the XP installation.

If the XP printer driver is not found, Windows XP prompts you to enter the path for the corresponding installation files. In addition to pre-installed drivers, a number of other printer drivers can be found in directory D:\I386.

Note: *When installing new printer drivers, you will be prompted to indicate the path of the new driver. This path may be on a disk in drive A. Alternatively, the driver can be loaded via a memory stick or USB CD-ROM drive (see section "Connection of USB Devices").*

Installation of Non-Plug&Play Printers

Note: *The dialogs below can be controlled either from the front panel or via the mouse and keyboard (see sections "Connecting a Mouse" and "Connecting a Keyboard"). Mouse and PC keyboard are absolutely essential for configuring network printers.*

A new printer is installed with the *INSTALL PRINTER* softkey in the *HCOPY* menu.

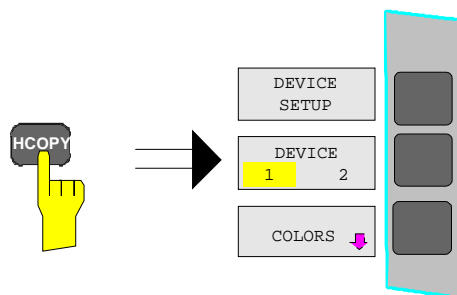

- Press the *HCOPY* key.
- The *HCOPY* menu will open.

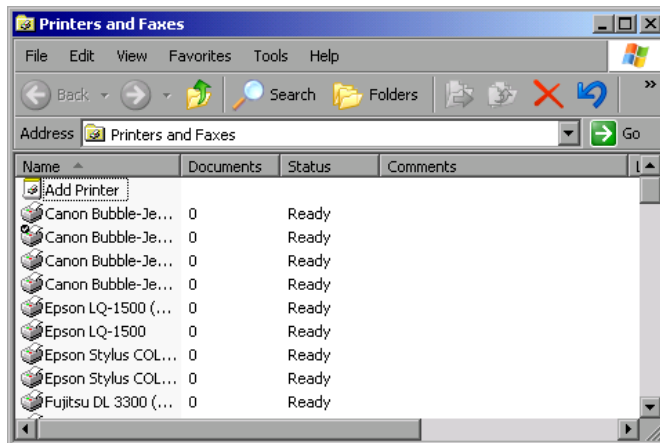
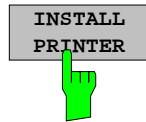
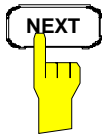

➤ Press the NEXT key to open the side menu.

➤ Press *INSTALL PRINTER* to open the *Printers and Faxes* dialog window.

➤ Select *Add Printer* in the list using the spinwheel.

➤ Highlight the selected item with *CURSOR RIGHT* and press *ENTER* or the spinwheel to confirm the selection.

The *Add Printer Wizard* is displayed.

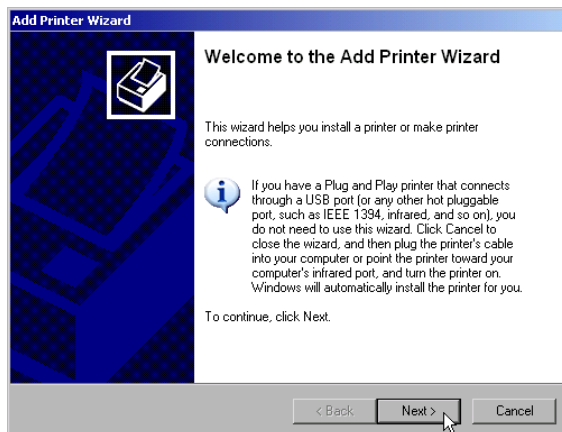

➤ Select *NEXT* with the spinwheel and press the spinwheel for confirmation.

Local or Network Printer can be selected.

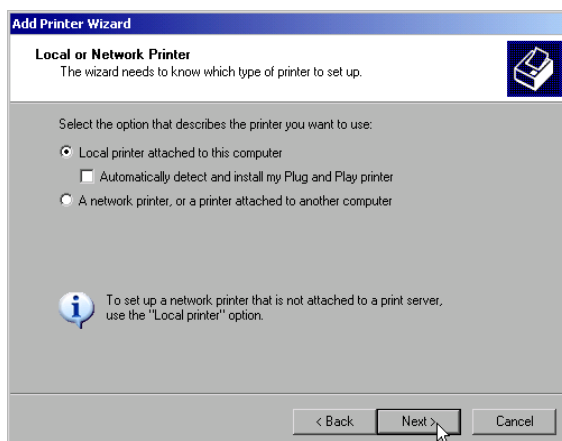

➤ To install a local printer, select *Local printer attached to this computer* with the spinwheel. Press the spinwheel for confirmation and continue with the "Local Printer" section.

➤ To install a network printer, select *A network printer or a printer attached to another computer*. Press the spinwheel for confirmation and continue with the "Network Printer" section.

Local Printer

In the following example, a Star LC24 printer is connected to the LPT1 interface and configured as *DEVICE2* for hardcopies of screen contents. The Add Printer Wizard has already been opened as described in the section "Starting the Add Printer Wizard" .

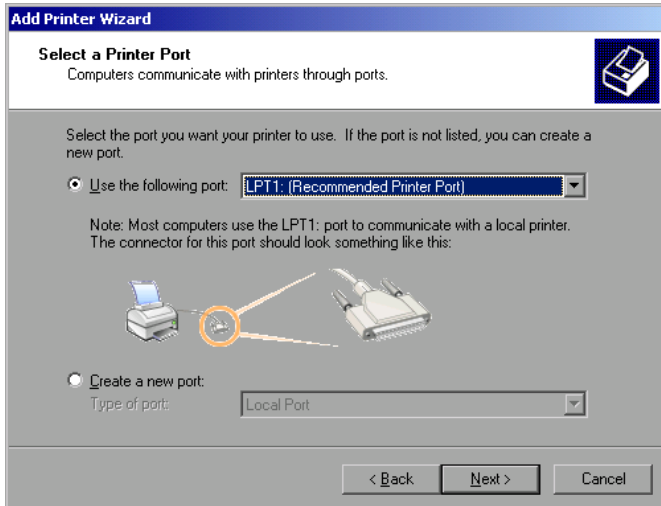

- To select the USB interface, open the list of ports by clicking the spinwheel. Select the printer port with spinwheel/arrow keys and confirm by pressing the spinwheel. The selection list is closed again.
 - To select the LPT connector, the selection list need not be opened.
 - Place the cursor on the *Next* button and confirm by pressing the spinwheel.
- The "Install Printer Software" dialog is opened.

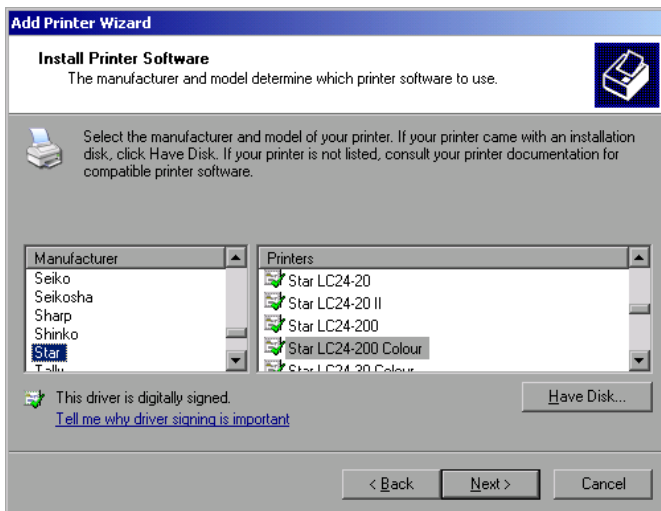

- Select the desired manufacturer ("Star") in the Manufacturer table using the up / down keys.

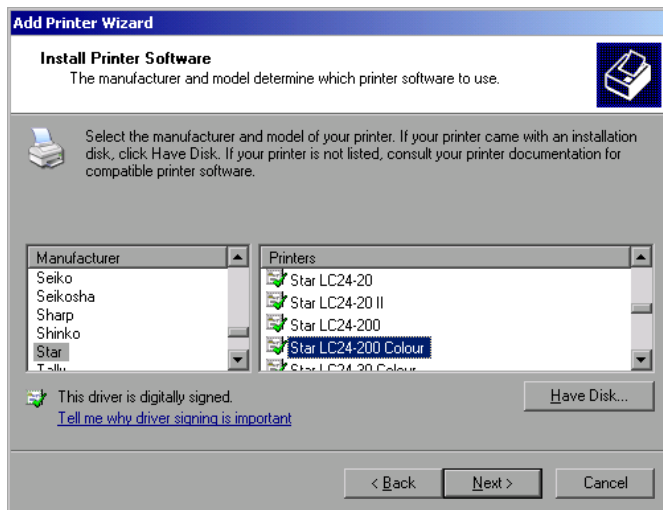

- Go to the *Printers* list with the spinwheel.
- Select the desired printer type (Star LC24-200 Colour) using the up / down keys and confirm with *ENTER*.

Note:

If the desired printer type is not in the list, the respective driver is not installed yet. In this case click the *HAVE DISK* button with the mouse key. You will be prompted to insert a disk with the corresponding printer driver. Press *OK* and select the desired printer driver.

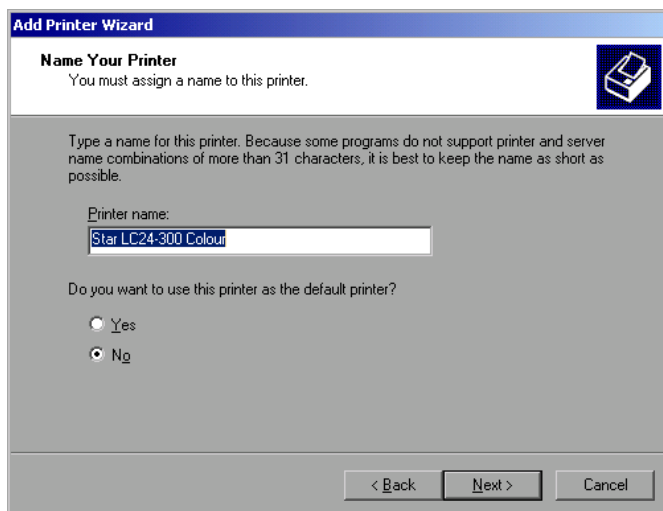

- The printer name can be changed as required in the *Printer name* entry field (max. 60 characters). A PC keyboard is required in this case.
- Use the spinwheel to select *Yes* or *No* for the default printer.
- Choose the desired status with the up /down keys.
- Confirm with *ENTER*.

The *Printer Sharing* dialog is opened.

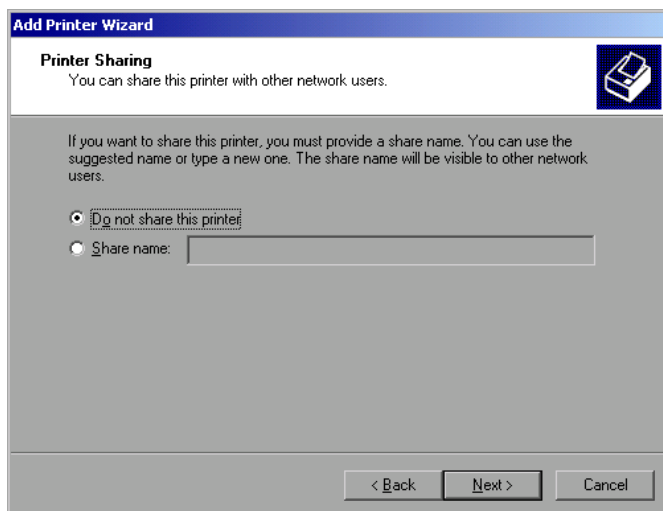

- Exit the dialog with *ENTER*.
- The *Print Test Page* dialog is opened.

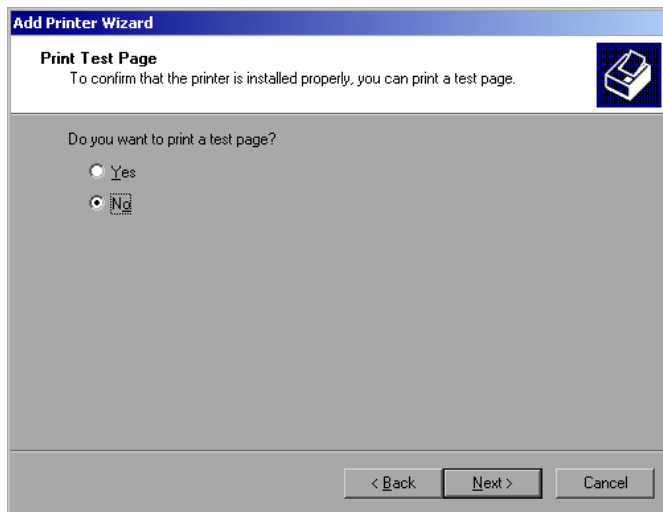

- Exit the dialog with *ENTER*.

The *Completing the Add Printer Wizard* dialog is opened.

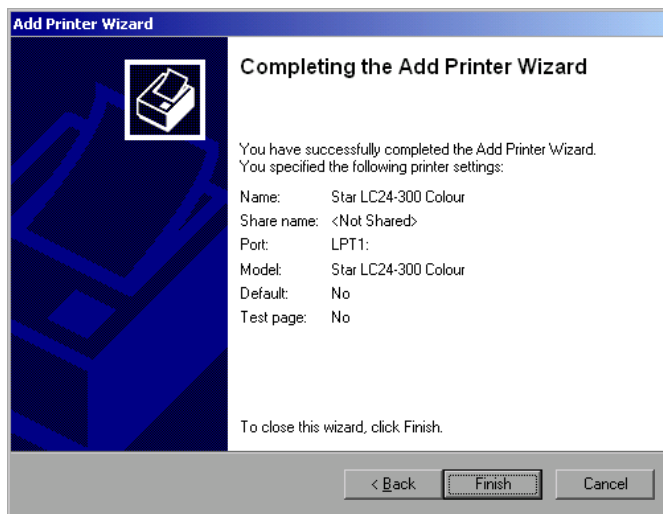

- Check the displayed settings and exit the dialog with *ENTER*.

The printer is installed. If Windows finds the required driver files, the installation is completed without any further queries.

If Windows cannot find the required driver files, a dialog is opened where the path for the files can be entered.

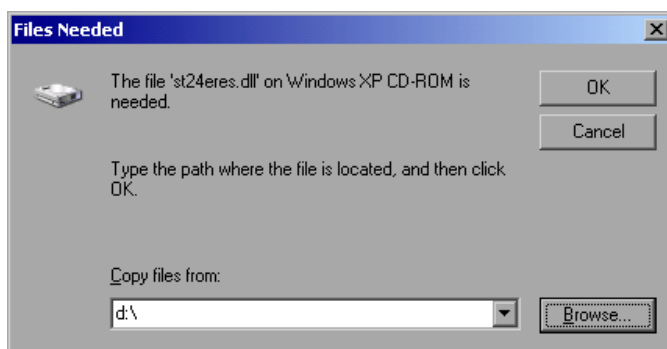

- Select the *Browse* button with the spinwheel and confirm with by pressing the spinwheel.

The *Locate File* dialog is opened.

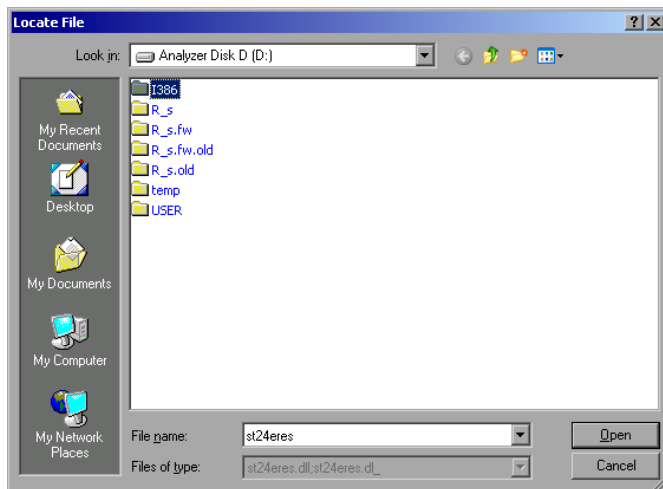

- Turn the spinwheel to select the directory and path D:\I386 and press it to confirm the selection.

If the selected item is not printed on a blue background, it must be marked with the cursor up / down keys before it can be activated by pressing the spinwheel.

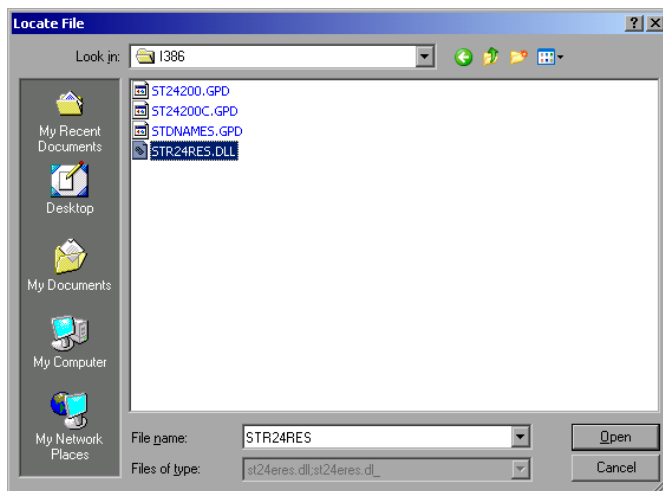

- Select the driver file with the spinwheel and confirm by pressing the spinwheel.

The file is included in the *Files Needed* dialog.

Note:

If the desired file is not in the D:\I386 directory, a disk with the driver file is needed. In this case, exit the dialog with ESC and repeat the selection starting from the "Files needed" dialog.

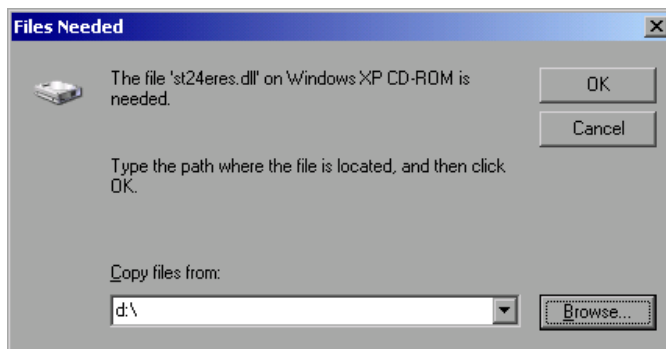

- Select the OK button with the spinwheel and press the spinwheel to confirm.

The installation is completed.

Finally, the instrument must be configured for printout with this printer using the softkeys *DEVICE SETUP* and *DEVICE 1/2* in the hardcopy main menu (see section "Selecting a printer").

Configuring a Network Printer

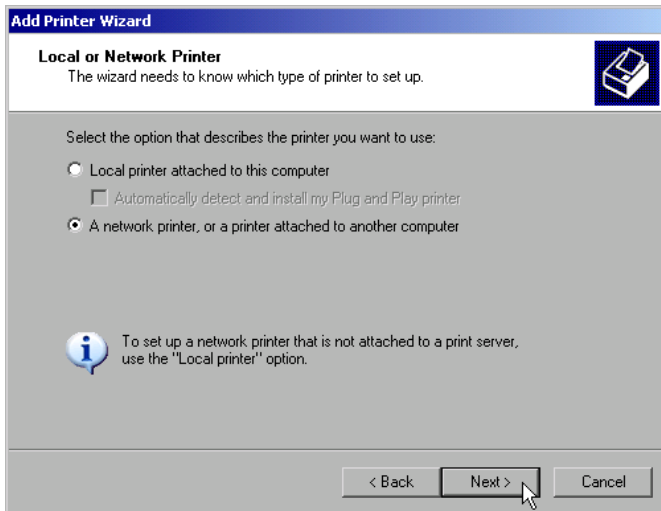

➤ To select a network printer, click the option "A network printer or a printer attached to another computer".

Continue with *Next*.

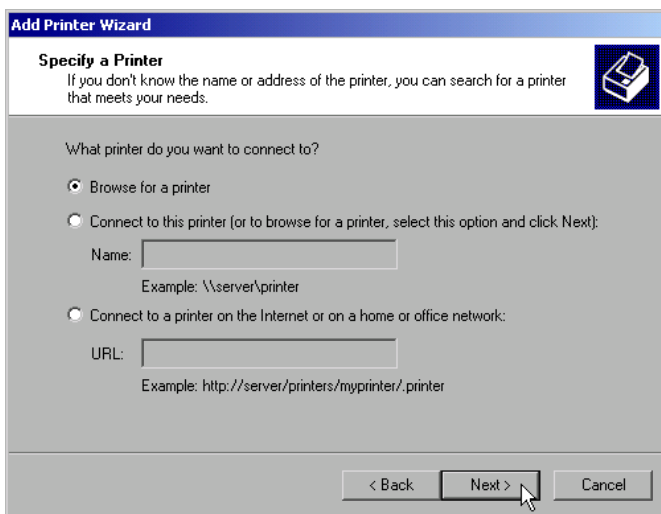

➤ Click *Browse for a printer* and then *Next*.
 A list of selectable printers is displayed.

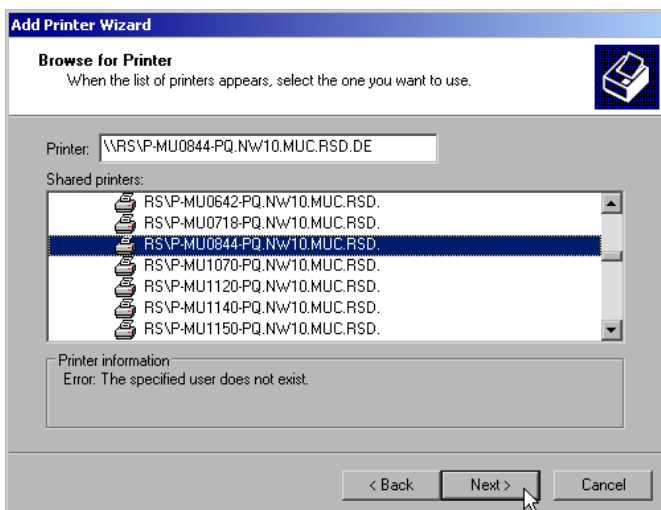

➤ Mark the desired printer and select it with **OK**.

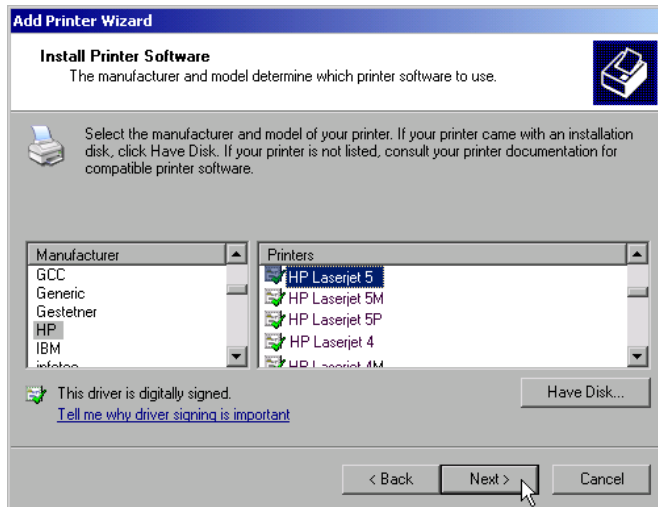

- Confirm the subsequent prompt to install a suitable printer driver with "OK". The list of available printer drivers is displayed. The manufacturers are listed in the left-hand table, the available printer drivers in the right-hand table.
- Select the manufacturer from the *Manufacturers* table and then the printer driver from the *Printers* table.

Note:

If the desired type of output device is not shown in the list, the driver has not yet been installed. In this case, click the "HAVE DISK" button. You will be prompted to insert a disk with the corresponding printer driver. Insert the disk, select "OK" and then choose the desired printer driver.

- Click Next.

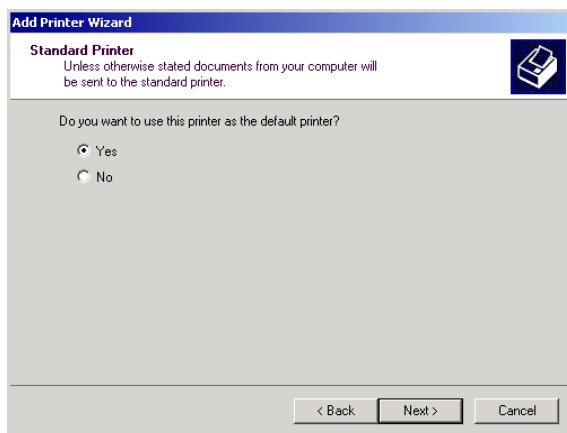

If one or more printers have already been installed, this window queries whether the printer last installed is to be used as the default printer for the Windows XP applications. The default selection is *No*.

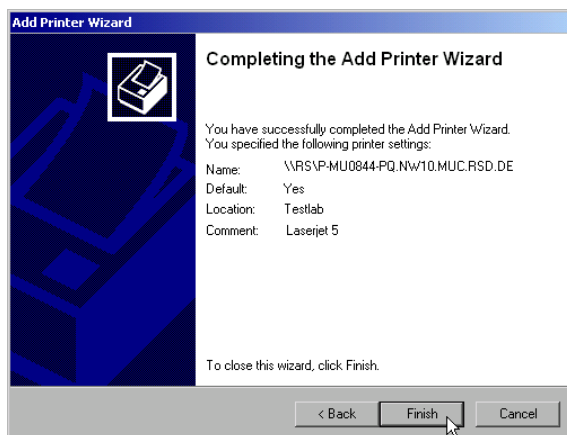

- Start the printer driver installation with *Finish*.

Finally, the instrument has to be configured for printout with this printer using the softkeys *DEVICE SETUP* and *DEVICE 1/2* in the hardcopy menu (see section "Selection of a Printer").

Connection of USB Devices

Up to two USB devices can be directly connected to the analyzer via the USB interface on the rear of the R&S ESCI. This number can be increased as required by interconnecting USB hubs.

Owing to the wide variety of available USB devices, the R&S ESCI can be expanded with almost no limitations. The following list shows a selection of USB devices suitable for the R&S ESCI:

- Power Sensor R&S NRP-Z11 or R&S NRP-Z21 (Adapter Cable R&S NRP-Z4 required)
- Pendrive (memory stick) for easy data transfer from/to the PC (e.g. firmware updates)
- CD-ROM drive for easy installation of firmware applications
- PC keyboard for entering comments, file names, etc
- Mouse for easy operation of Windows dialogs
- Printer for documentation of measurement results
- Modem for remote control of the R&S ESCI over great distances

The installation of USB devices is quite simple under Windows XP since all USB devices are Plug&Play. Apart from the keyboard and the mouse, all USB devices can be connected to or disconnected from the R&S ESCI while the instrument is running.

After the instrument is connected to the USB interface, Windows XP automatically searches for a suitable device driver.

If Windows XP does not find a suitable driver, you will be prompted to specify a directory where the driver software can be found. If the driver software is on a CD, a USB CD-ROM should first be connected to drive to the R&S ESCI.

As soon as the connection between the R&S ESCI and the USB device is interrupted, Windows XP will again recognize the modified hardware configuration and will deactivate the corresponding device driver.

Example:

Connecting a pendrive (memory stick) to the R&S ESCI:

1. After the pendrive is connected to the USB interface, Windows XP will recognize the newly connected hardware:

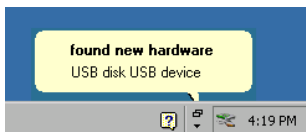

2. Windows XP installs the corresponding driver.
After successful installation, XP signals that the unit is ready for operation:

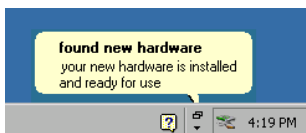

3. The pendrive is now available as a new drive and is displayed in Windows Explorer:

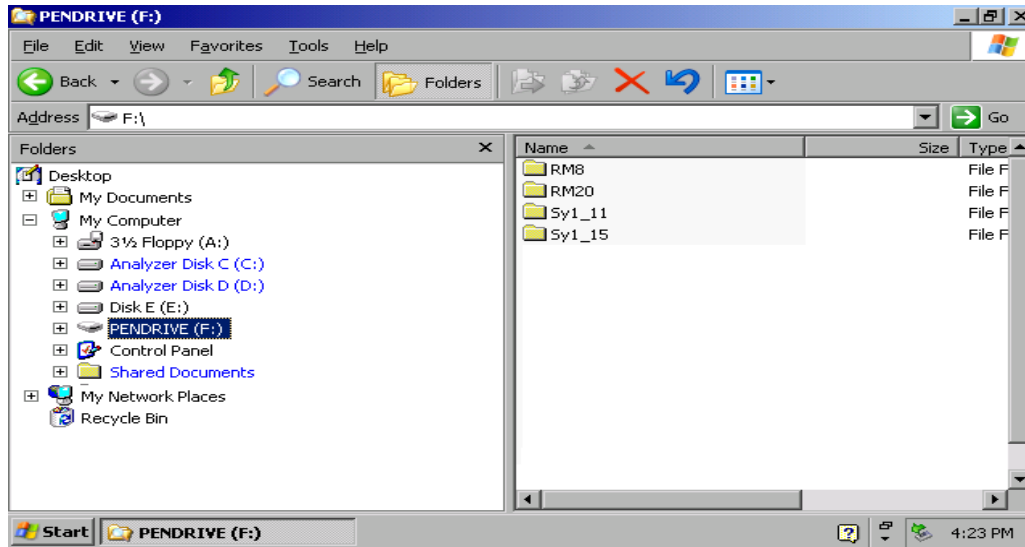

The pendrive can be used as a normal drive to load or save files.

4. If the pendrive is no longer required or if files are to be transferred to another computer, the pendrive is simply disconnected. Windows XP will then deactivate the driver. If the corresponding drive is still selected in Explorer, an error message will be displayed indicating that the drive is no longer available.

Installing Windows XP Software

Authorized Windows XP Software for the Instrument

The driver software and the system settings of Windows XP are adapted to the measurement functions of the instrument. Correct operation of the instrument can therefore be guaranteed only if the software and hardware used are authorized or supplied by Rohde & Schwarz.

The following program packages have been successfully tested for compatibility with the instrument's software:

- R&S FS-K3 – software for measuring noise factor and gain
- R&S FS-K4 – software for measuring phase noise
- R&S Power Viewer
(virtual power sensor for displaying the results of Power Sensors NRP-Z11 and -Z21)
- Windows XP remote desktop
- FileShredder – for deleting files from the hard disk
- Symantec Norton AntiVirus – software for protection against viruses

The use of other software or hardware may cause failures in the functions of the R&S ESCI. A current list of the software authorized for use on the R&S ESCI can be obtained from your nearest Rohde & Schwarz agency (see list of addresses).

Contents - Chapter 2 "Getting Started"

4 Getting Started

- Measurement Example.....2.1
 - Example of Level and Frequency Measurement.....2.2
 - Measurement2.2
 - Main Test Receiver Functions2.2
 - Measurement Sequence - Level and Frequency Measurement.....2.2

2 Getting Started

Chapter 2 provides a fast introduction to operation by guiding the user step by step through a measurement example.

Before starting any measurement with the R&S ESCI, please note the instructions given in chapter 1 for putting the instrument into operation. In chapters 3 you will find detailed information on customizing the instrument and the display.

For a systematic explanation of all menus, functions and parameters and background information refer to the reference part in chapter 4.

Measurement Examples and Applications

This section describes a typical and simple measurement task for an EMI test receiver. Each operating step is explained with the aid of R&S ESCI for rapid familiarization of the user without the need to know all the details of the operating functions.

In the introductory example a **standard measurement** of level and frequency is performed with the aid of the SCAN table. This measurement is an overview and precertification measurement to be performed before the final standard-conformal measurement is carried out.

Note: *If unknown (RFI) signals are to be measured, it is strongly recommended to provide for at least 10 dB RF attenuation at the RF input in order to protect the input circuit.*

In the following example the test receiver is set to default values in the receiver mode. The default setup is activated by pressing first the *RECEIVER* hotkey and then the *PRESET* key. The main default parameters are listed in the following table.

Table 2-1 Default parameters after preset in receiver mode

Parameter	Setting
Receiver frequency	100 MHz
RF attenuation	Auto
Preamplifier	Off
Detector	AV
Measurement time	100 ms
RES bandwidth	120 kHz
Demodulator	Off
Trigger	Free run

Example of Level and Frequency Measurement

Measurement

Measurement and display of RFI signal levels versus frequency is one of the most frequent tasks performed by an EMI test receiver. In the case of unknown signals, *PRESET* values will mostly be used for the measurement. If levels higher than +137 dB μ V (10 dB RF attenuation) are expected or possible, a power attenuator has to be connected in front of the test receiver input. Very high levels may otherwise damage or destroy the attenuator or input mixer.

Main Test Receiver Functions

The main functions required for the level and frequency measurement are setting the SCAN table (*START FREQUENCY*, *STOP FREQUENCY*, *STEPSIZE*), selecting the resolution (IF) bandwidth (RES BW), setting the measurement time (MEAS TIME) and selecting the detectors (eg peak or average) and *MARKER* functions required for the analysis.

Measurement Sequence - Level and Frequency Measurement

In this example the spectrum of the signal present at RF INPUT is recorded in the frequency range 150 kHz to 30 MHz. The scan table and associated parameters are manually set.

The example is generally suitable for all fast pre-compliance measurements required for measuring unknown noise spectra of DUTs in the development stage and for modifying prototypes and can be used as a basis for final tests later on.

The high speed of fully synthesized scans, the frequency and amplitude accuracy and the wide dynamic range of Test Receiver R&S ESCI are of utmost importance and very useful for these measurements.

The following measurement steps are performed:

1. *PRESET* of instrument.
2. Selecting *RECEIVER* mode (*RECEIVER* hotkey).
3. Programming the scan table: stop frequency 30 MHz, 1 scan range
4. Selecting detectors, measurement bandwidth and measurement time
5. Applying the signal (RF input)
6. Starting the scan
7. Level analysis in the frequency domain using *MARKER* function
8. Setting the *SPLIT SCREEN* function
9. Tuning to the receiver frequency using the *TUNE TO MARKER* function
10. From overview to standard-conformal measurement
11. Storing test results, tables and diagrams

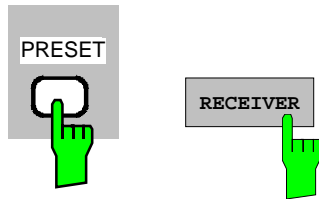

1. **Resetting the instrument and**
2. **Selecting the RECEIVER mode**

➤ Press first the *PRESET* key and then the *RECEIVER* hotkey.

The main receiver menu is opened. The receiver mode is set.

The following screen is displayed:

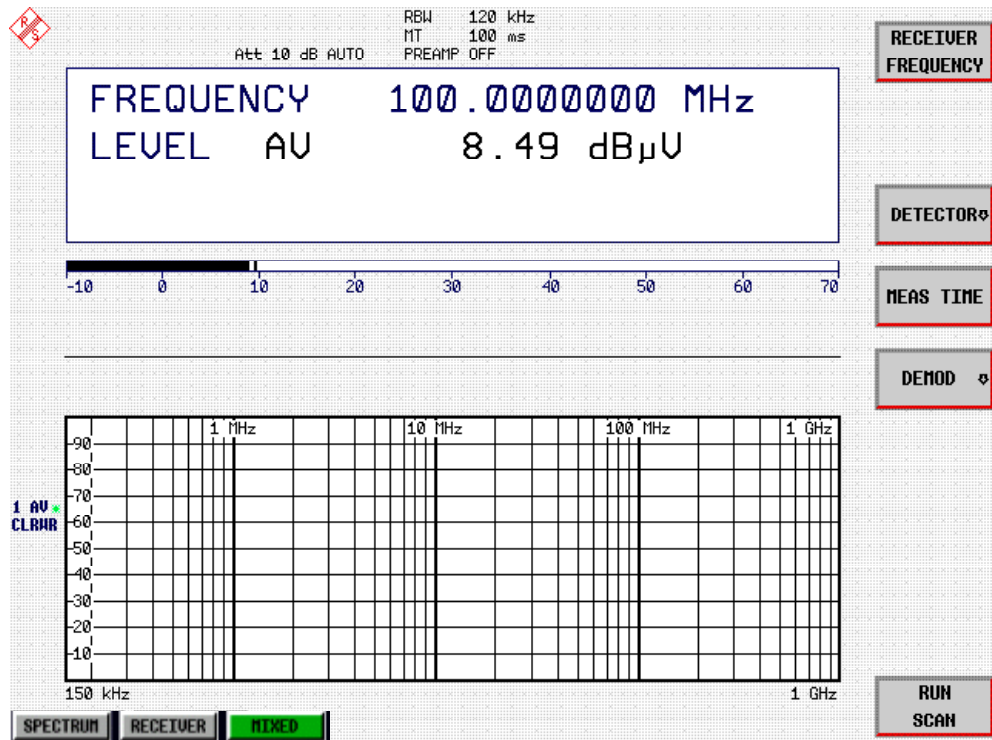
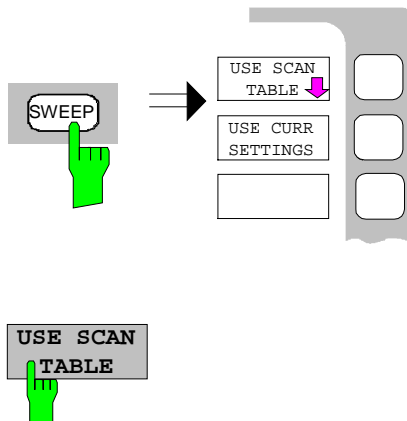

Fig.2-1 Display after selecting the default setup in receiver mode



3. Programming a SCAN table

➤ Press the *SWEEP* key.

➤ In the *SWEEP* menu press the *USE SCAN TABLE* softkey.

A menu is displayed where the whole display range can be defined and divided into scan subranges.

After *PRESET* a scan range of 150 kHz to 1 GHz is preset on the frequency axis.

Now the stop frequency is set to 30 MHz.

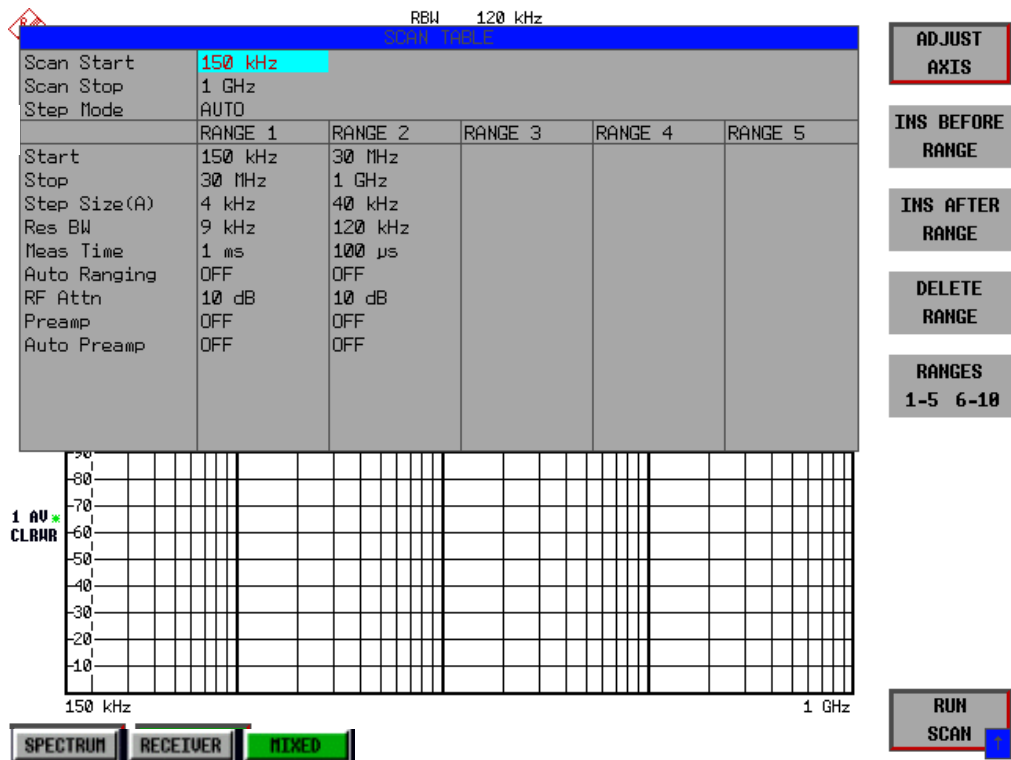
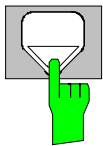
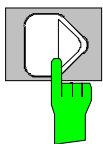

Fig.2-2 Scan range after selecting default setup with PRESET



➤ Press the DOWN cursor in the *DATA VARIATION* field repeatedly until a line in the scan table is marked.



➤ Press the RIGHT cursor key in the *DATA VARIATION* field.
An entry in the *RANGE 2* column is marked.



➤ Press the *DELETE RANGE* softkey.
All entries in column *RANGE 2* are cleared.
The following scan table is now displayed:

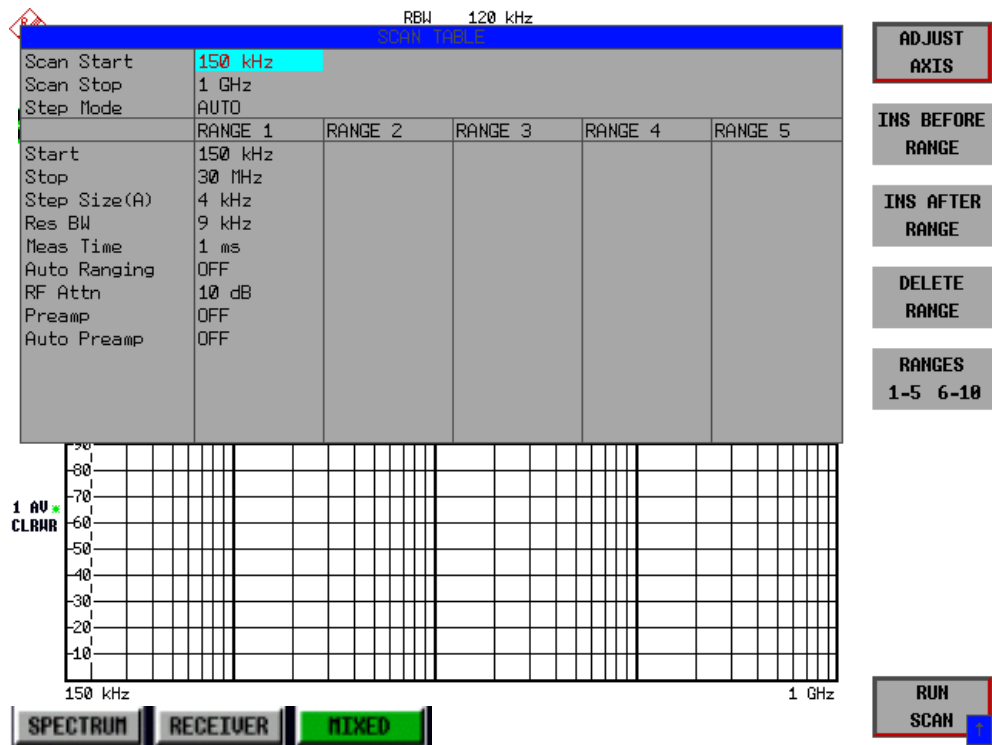

Fig.2-3 Modified SCAN table for preparing a SCAN

After editing the scan subrange, the frequency display has to be adapted to the new settings. The lowest START frequency of SCAN range 1 and the highest STOP frequency of the subsequently defined subranges are used for defining the start and stop frequencies of the graphics display. In the example the limit frequencies of SCAN RANGE 1 are therefore also the limits of the graphics display.



- Press the *ADJUST AXIS* softkey.

The respective frequency values in the table are transferred to adapt the display.

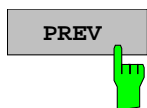

- Press the menu change key *PREV*.

The *USE SCAN TABLE* submenu is closed.

4. Selecting detectors

Up to three detectors can be connected in parallel to simultaneously display the amplitude at every frequency as a function of detector weighting. When a parallel detector is selected, the slowest detector (in the sense of a calibrated measurement) determines the speed or the total measurement time required for the scan. The fastest scan is performed when the peak detector is used as the sole detector.

In the example, the peak detector (trace 1) and the average detector (trace 2; default) are used in an overview measurement.

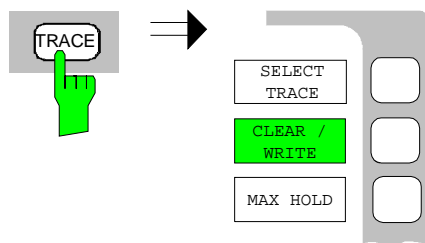

- Press the *TRACE* key.

The *TRACE* menu is opened where the trace can be selected and the detector for the selected trace can be determined.



- Press the *SELECT TRACE* softkey.

A data input field is opened where the number of the trace, here 1, can be entered. The input is confirmed with the *ENTER* key.

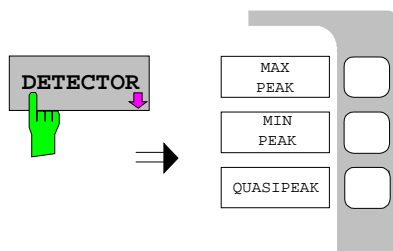

- Press the *DETECTOR* softkey.

The *DETECTOR* menu is opened where different detectors, *MAX PEAK*, *MIN PEAK*, *QUASIPeAK*, *AVERAGE* and *RMS*, can be selected for trace 1.



- Press the *MAX PEAK* softkey.

The peak detector is selected.

- Repeat the settings for trace 2.
- Press the *CLEAR / WRITE* softkey.

In the *DETECTOR* menu select the *AVERAGE* detector.

5. Applying the signal

- Connect RF cable to the RF input.

6. Starting the scan

- Press the *SWEEP* key.

The *SWEEP/SCAN* menu is opened.

- Press the *RUN SCAN* softkey.

The measurement with the selected *PEAK* and *AVERAGE* detectors is continuously repeated because the default setting *CONTINUOUS SCAN* remains unchanged.

At the same time the *HOLD SCAN* and *STOP SCAN* softkeys are displayed with the aid of which the scan can be interrupted (*HOLD SCAN*) or aborted (*STOP SCAN*).

In the example the scan should be aborted.

- Press the *STOP SCAN* softkey.

The measurement is aborted.

Peak and average results (see following figure) should be further analyzed with the aid of the built-in marker functions.

Depending on the DUT, diverse trace forms are obtained. For this reason the diagram below should be regarded as an example.

The scaling of the y-axis can be adjusted in the *AMPT* menu by means of softkey *GRID RANGE LOG MANUAL* if necessary.

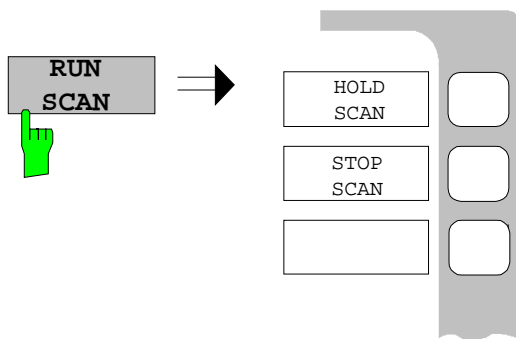

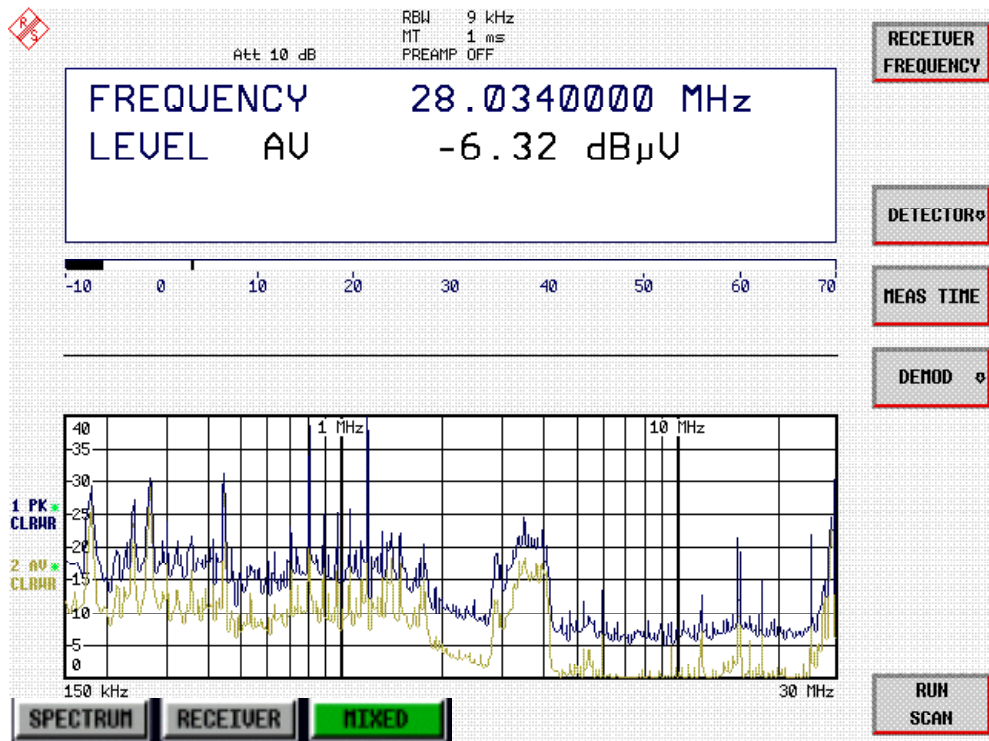

Fig.2-4 Result display of standard pre-compliance measurement using peak/average detector



7. Level analysis in frequency domain using MARKER functions

➤ Press the *MRK* key.

The marker jumps to the largest signal peak shown on the display screen.

Note: When the marker is switched on for the first time, it automatically performs the *PEAK SEARCH* function as demonstrated in this example.

If a marker was already active, the *PEAK* softkey in the *MRK->* menu must be pressed in order to set the currently active marker to the displayed signal maximum.

The level and frequency measured by the marker can be read in the marker field at the upper edge of the display screen.

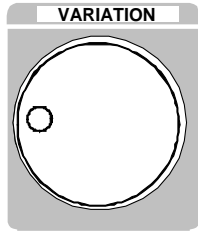

- Move the marker on the trace with the aid of the spinwheel.

The respective level and frequency values are displayed in the marker field.

**or with
PEAK search functions**

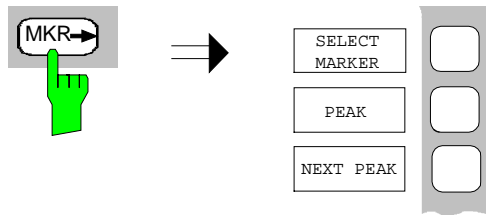

- Press the *MKR->* key.
The *MARKER->* menu is opened.

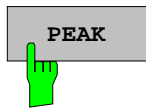

- Press the *PEAK* softkey.
The marker is positioned at the maximum level in the display.



- Press the menu change key *NEXT*.
The right submenu is opened.

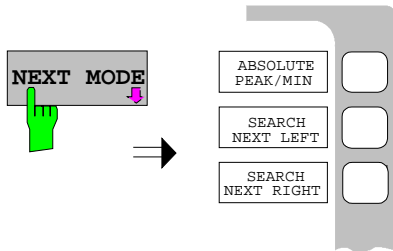

- Press the *NEXT MODE* softkey.
The *NEXT MODE* submenu is opened.



- Press the *ABSOLUTE PEAK/MIN* softkey.

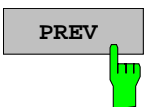

- Press the menu change key *PREV*.
The *NEXT MODE* menu is closed.

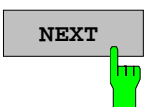

- Press the menu change key *NEXT*.
The left submenu is opened.



- Press the *NEXT PEAK* softkey.
The marker moves to the next lower level in the spectrum irrespective of whether the frequency is higher or lower than that of the previously measured *PEAK* value.

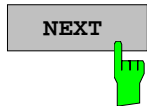

- Press the menu change key *NEXT*.
The right submenu is opened.

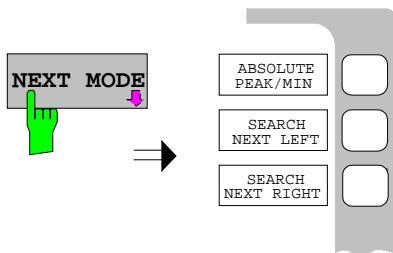

- Press the *NEXT MODE* softkey.
The *NEXT MODE* submenu is opened.



- Press the *SEARCH NEXT RIGHT* softkey.

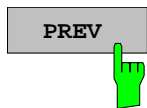

- Press the menu change key *PREV*.
The *NEXT MODE* menu is closed.

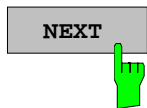

- Press the menu change key *NEXT*.
The left submenu is opened.



- Press the *NEXT PEAK* softkey.
The marker is displayed on the next level at a higher frequency (see following figure).
The displayed spectrum can be further analyzed with the aid of up to four markers. The markers can be assigned to different traces.

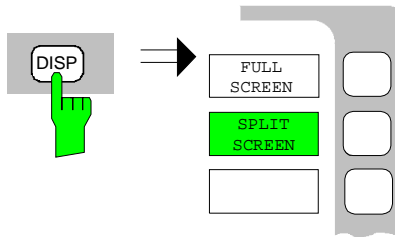

- Press the *DISP* key in the *SYSTEM* field.
The *SYSTEM DISPLAY* menu is opened.

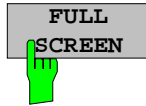

- Press the *FULL SCREEN* softkey.
One window is displayed on the screen

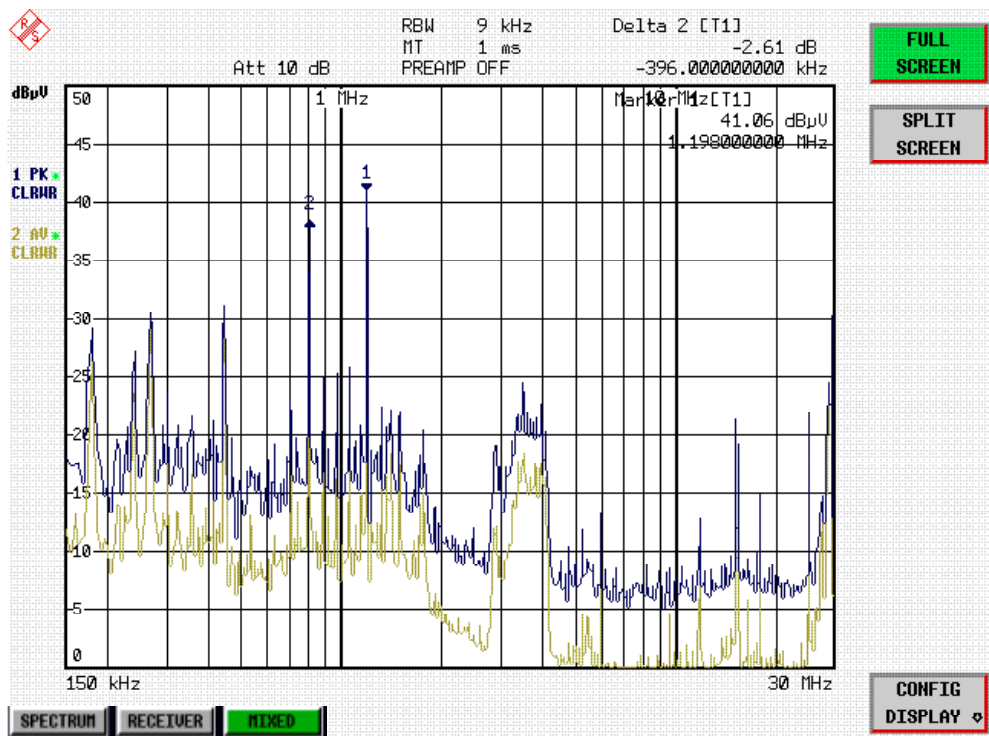
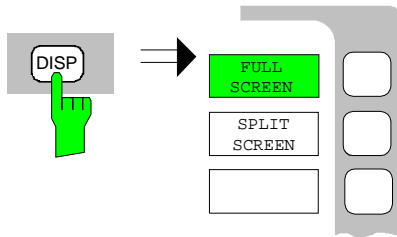

Fig.2-5 Screen display with marker

8. Setting the *SPLIT SCREEN* function

The *SPLIT SCREEN* function simplifies the analysis of measured data, particularly at critical frequencies. In the split-screen mode, the frequency, eg that of the active marker, and the level of the active detectors are displayed in the upper half of the screen numerically and on a bargraph.



- Press the *DISP* key in the *SYSTEM* field.
The *SYSTEM DISPLAY* menu is opened.

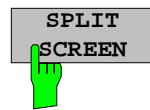

- Press the *SPLIT SCREEN* softkey.
Two windows are displayed on the screen.

9. Tuning the receiver frequency and obtaining final test results using the QUASI-PEAK detector

The currently measured frequency can be rapidly changed eg with the *TUNE TO MARKER* softkey in the *MKR→* menu. Other or additional detectors can be switched on at this receive frequency and an overview of levels of all active detectors is given. For measurements to standard, the measurement time must first be set to 1 s.



- Press the *MKR* key.
Marker 1 is displayed.
Frequency and level values can be read in the marker field at the top left of the screen.

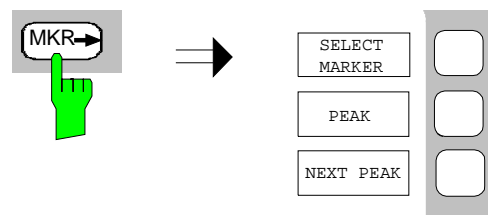

- Press the *MKR→* key.
The *MARKER →* menu is opened.



- Press the *TUNE TO MARKER* softkey.
The current receive frequency is tuned to the marker frequency.
A measurement time of 1 s must be set for measurements to standard.

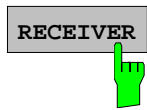

- Press the *RECEIVER* hotkey.
The *RECEIVER* menu is opened.

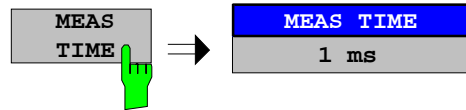

- Press the *MEAS TIME* softkey.
The window with the currently set measurement time is opened (1 ms in the example).
- Enter 1 on the numeric keypad and terminate by pressing s.

The new measurement time is displayed.

The quasi-peak detector should now be switched on in addition.

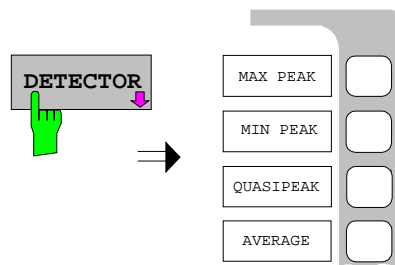

- Press the *DETECTOR* softkey.

The *DETECTOR* menu is opened. The peak and average detectors of the pre-compliance measurement are active.

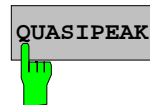

- Press the *QUASI-PEAK* and the *MAX PEAK* softkey.

The *LEVEL* at the current receive frequency is displayed for three detectors numerically and on three bargraphs (see following figure).

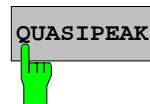

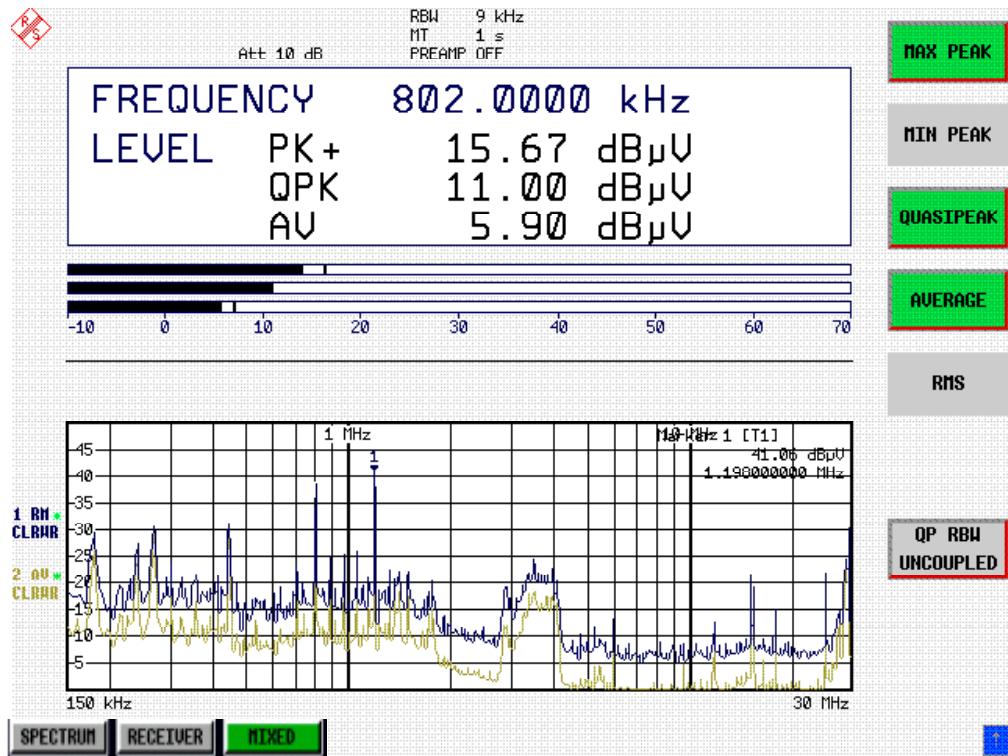

Fig.2-6 Analysis of single frequencies with standard measurement time and several detectors

10. *From overview to standard-conformal measurement*

Data reduction and automatic routines for final measurement

The R&S ESCI offers several data reduction methods for interactive or automatic final measurements.

The methods are described in Chapter 4, Section "Data Reduction and Subrange Maxima".

Limit lines

A final measurement to standard can be performed when active limit lines are displayed in the diagram during the described analysis and measurements are repeated at all critical frequencies using the standard measurement time and a corresponding detector.

The use and setting of limit lines is described in Chapter 4, Section "Limit Lines - LIMIT Key".

Transducer

Care should be taken that the correction values or transducer factors available in tabular form are considered in the measurement result when accessories with frequency-dependent characteristics are used. Several correction tables can be combined to form a transducer set.

The use and entry of transducer tables is described in Chapter 4, Section "Using Transducers".

11. *Storing test results, tables or diagrams on floppy*

In the example, test results are stored on a floppy. Measured data are output to a file type *.wmf for use in other applications.

DEVICE1 and output to a file type *.wmf is automatically selected with *PRESET*.

The display elements are now selected.

-
- Press the *HCOPY* key.

The *HCOPY SETTINGS* menu is opened where the output of measurement and device data can be configured and started.

-
- Insert a floppy into the floppy disk drive.



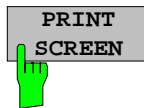

- Press the *PRINT SCREEN* softkey.

The output is started. A window is displayed where the file name and the path must be entered using the built-in auxiliary line editor or the external keyboard, eg

A:\display.wmf.

- Press the *ENTER* key.

The screen content is stored on the floppy under the specified file name.

During storing the softkeys are blanked. Operation in the menus can be continued when the softkeys are displayed again.

The file can be used in other Windows applications, ie it can be linked.

Fig. 2-7 gives an example of a stored display. In the example, two limit lines are active and four markers positioned in the spectrum.

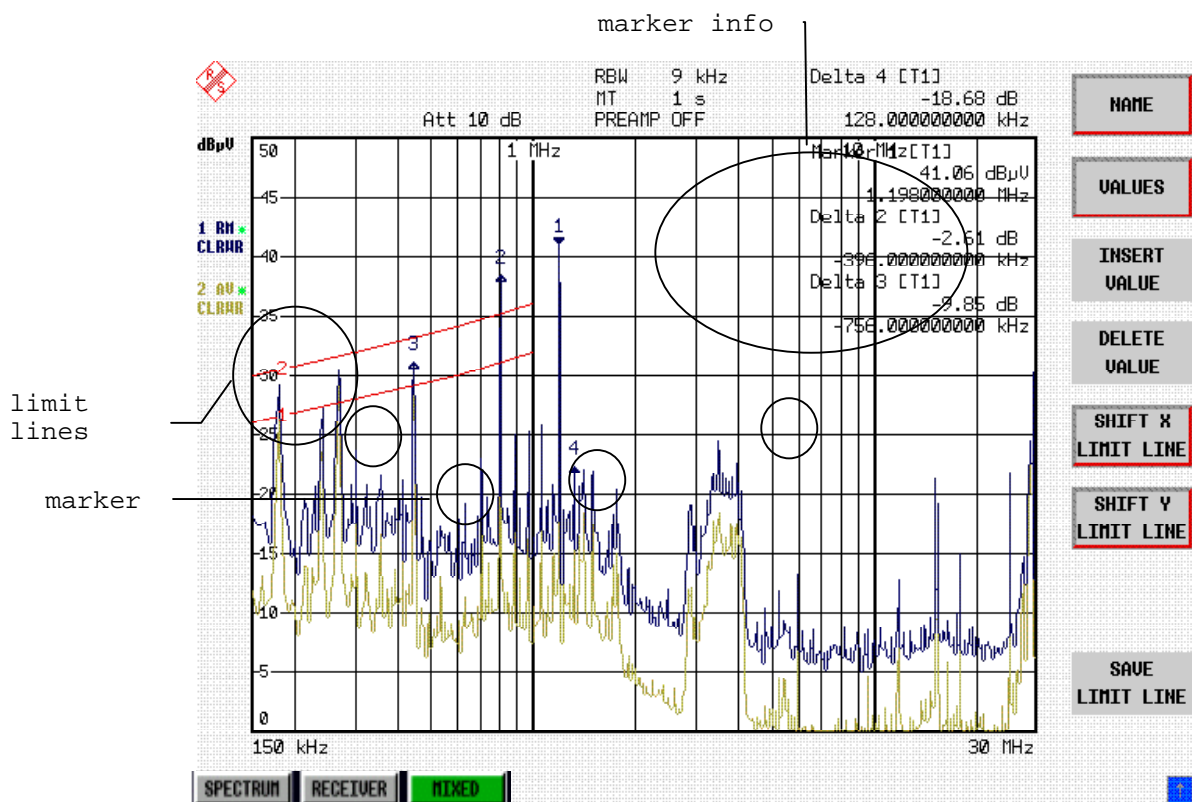

Fig. 2-7 Result display stored in a file in WMF format

Note: A detailed description of the file management for complete receiver setups, data records for traces (traces 1-3), limit lines and transducer is given in in Chapter 4, Section "Management of Data Files".

Contents - Chapter 3 "Manual Operation"

3 Manual Operation	3.1
The Screen	3.1
Diagram Area	3.2
Indications in the Diagram Area	3.3
Full Screen	3.9
Split Screen.....	3.9
Softkey Area	3.10
Hotkey Area.....	3.11
Calling and Changing the Menus	3.12
Setting Parameters	3.13
Numeric Keypad.....	3.13
Spinwheel and Cursor Keys	3.14
Selection and Setting of Parameters via Keys or Softkeys	3.15
Editing of Numeric Parameters	3.18
Entry of Alphanumeric Parameter	3.21
Selection and Setting of Parameters via Tables	3.25
Menu Overview	3.28
FREQ Key	3.28
SPAN Key.....	3.29
AMPT Key	3.30
MKR Key	3.31
MKR-> Key	3.32
MKR FCTN Key.....	3.34
BW Key	3.35
SWEEP Key	3.36
MEAS Key	3.37
TRIG Key.....	3.39
TRACE Key	3.40
LINES Key.....	3.41
DISP Key.....	3.42
FILE Key.....	3.43
CAL Key	3.44
SETUP Key	3.45
HCOPY Key.....	3.47
Hotkey Menu	3.48
LOCAL Menu.....	3.48
Menu Overview RECEIVER Hotkey	3.49
Menu Overview Network Mode	3.50
Menu Overview Option Ext. Generator Control	3.51
Menu Overview Option Mixed	3.52

3 Manual Operation

Chapter 3 provides an overview of the operating concept and the basic steps of manual operation of the R&S ESCI. This includes a description of the screen, of the control of menus and of the setting of parameters. An overview of the menus will be listed at the end of this chapter.

The functions of the menus are described in detail in Chapter 4. Chapter 2 contains a short introduction on step-by-step simple measurements. The remote control of the instrument is described in Chapters 5, 6 and 7

The operation of the spectrum analyzer is menu-controlled via keys, hotkeys and softkeys. The setting of the instrument and test parameters in the menus is made either directly via softkeys or by entry of values in entry fields and by selection in tables. The operating mode and the screen mode is selected via the hotkeys.

If required, data entry windows and tables are superimposed on the screen.

The Screen

The screen informs continuously on the results and parameters of the selected measuring functions. It shows the assignment of the softkeys and menus, which are required for setting the measuring parameters. The display of test results, the softkey labeling and the type of menu depend on the selected measuring function.

The screen is subdivided into three areas:

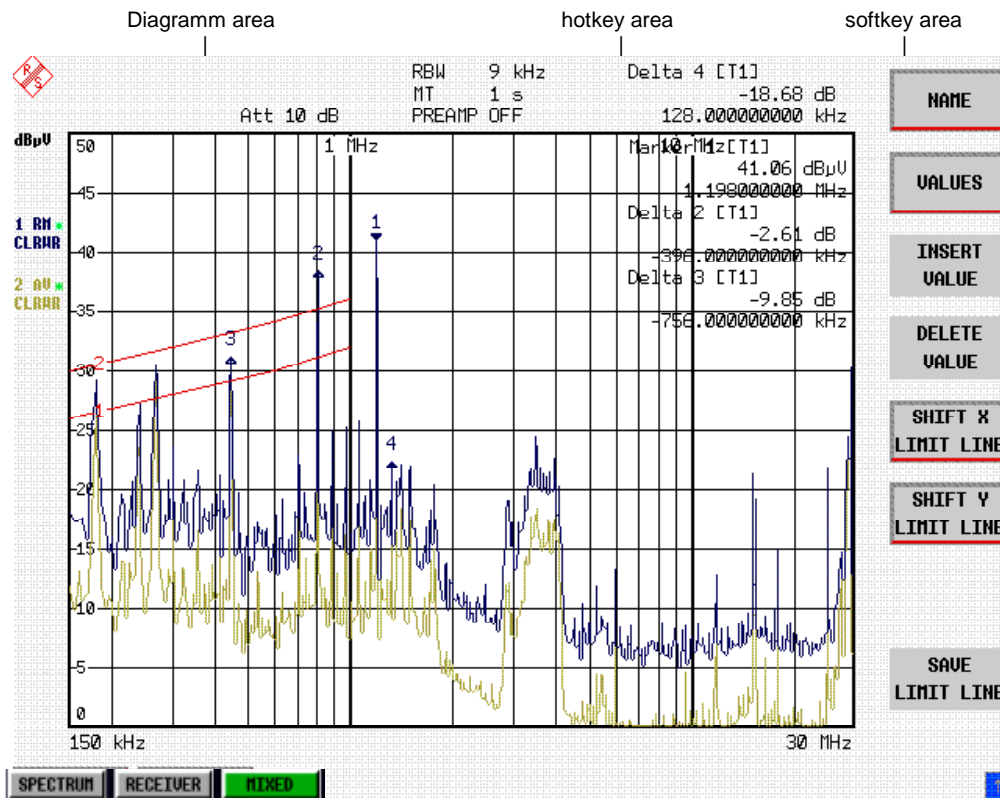

Fig. 3-1 Subdivision of screen

Diagram area This area contains the measuring diagrams and other measured-value information as well as the parameters and status information which are important for analysis of the results.
In addition, message fields, entry windows and tables may be shown in this area.

Softkey area This area contains the instrument functions which can be selected via the softkeys. The softkey area is not superimposed by other graphics.

Hotkey area This area contains the available operating modes and screen modes. The hotkey area is not superimposed by other graphics.

Diagram Area

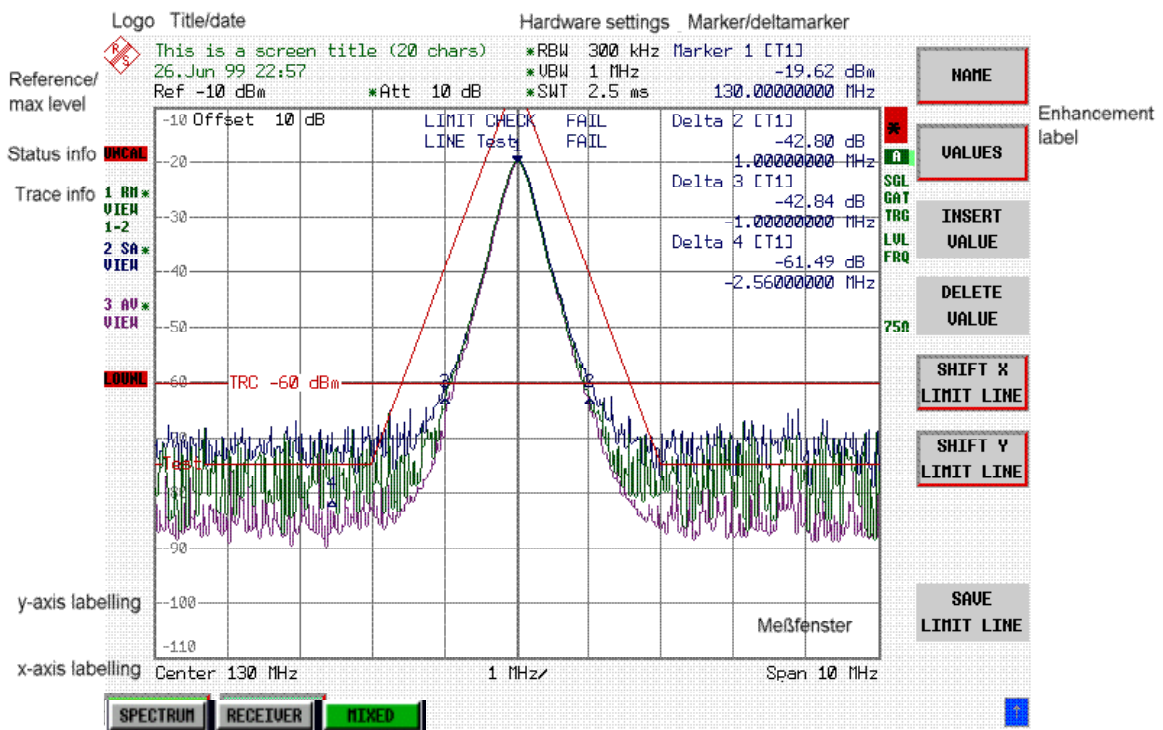

Fig. 3-2 Subdivision of the R&S ESCI screen in analyzer mode

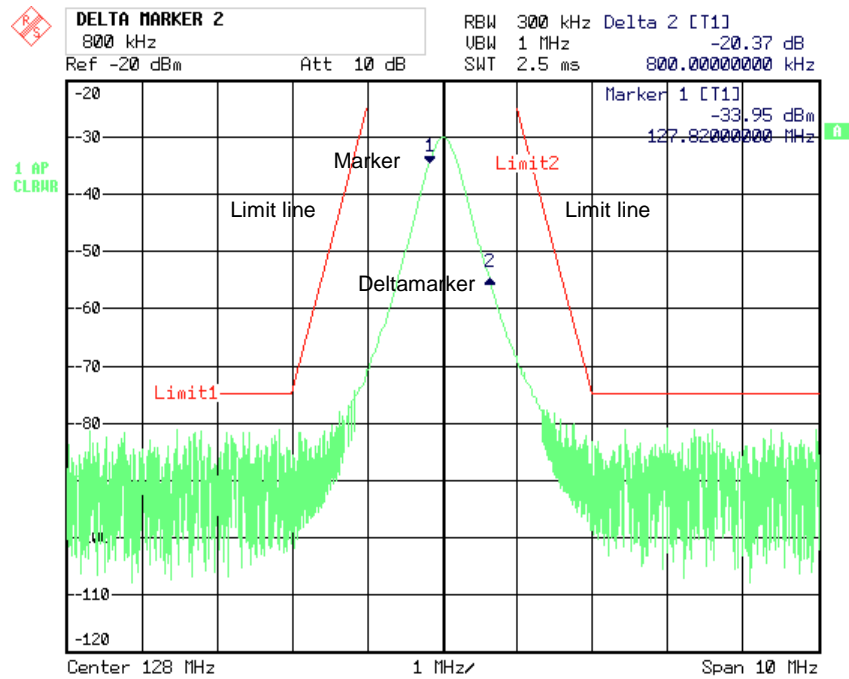

Fig. 3-3 Measuring diagram

Indications in the Diagram Area

The following graphic elements are displayed in the diagram area:

General indications	Indication of the logo
Logo	
Screen title	Indication of selected screen title
Date / time	Indication of date and time
Hardware settings	
Receiver mode	
RBW	Indication of the set IF bandwidth.
Att	Indication of the set RF attenuation.
MT	Indication of the set measurement time
PREAMP	Indication of preamplifier status.

Analyzer Mode

Ref	Indication of the reference level
Offset	Indication of the offset of reference level.
Att	Indication of the set RF attenuation.
RBW	Indication of the set resolution bandwidth. If the bandwidth does not correspond to the value of the automatic coupling, a green asterisk "*" is prefixed to the field.
VBW	Indication of the set video bandwidth. If the bandwidth does not correspond to the value of the automatic coupling, a green asterisk "*" is prefixed to the field.
SWT	Indication of the set sweep time. If the sweep time does not correspond to the value of the automatic coupling an asterisk "*" is prefixed to the field. The colour of the asterisk turns red as soon as the sweep time falls below the value of the automatic coupling.

Marker/deltamarker

This label displays the position of the last selected marker or deltamarker in the x and y-directions and the marker/deltamarker index. The square brackets contain the curve which the marker is assigned to and the active measuring function of the marker indicated. The measuring function of the markers in the second field is indicated by the following abbreviations:

FXD	reference fixed active
PHN	phase noise measurement active
CNT	frequency counter active
TRK	signal track active
NOI	noise measurement active
MOD	measurement of AM modulation depth active
TOI	TOI measurement active (3 rd order intercept)

Limit check

Indication of the result of the limit check.

X-axis labelling

Display of the x-scaling.

{10 MHz/DIV }

The distance between two grid lines is displayed in this label.

{Center 1.2345678901234 GHz }

The set center frequency or start frequency is displayed in this label depending on whether the keys FREQ/SPAN or the softkeys START/STOP were last pressed.

{Start 1.2345678901234 GHz }

If span = 0 Hz, the center frequency is always displayed.

{Span 1.2345678901234 GHz }

The set frequency range (SPAN) or the stop frequency is displayed, depending on whether the keys FREQ/SPAN or the softkeys START/STOP were last pressed.

{Stop 1.2345678901234 GHz }

If span = 0 Hz, the trigger moment (PRETRIGGER) is displayed.

{Trigger 1.234 ms }

Status information	The status information on the left side of the diagram hint at irregularity (e.g. UNCAL)
#SMPL	"#SMPL" indicates that the relation Span / RBW is higher than 125 while the RMS detector is activated. In this case, a stable signal evaluation is no longer possible due to an insufficient number of A/D converter samples. ⇒ reduce span or increase RBW
UNCAL	"UNCAL" is indicated under the following circumstances: <ul style="list-style-type: none">• correction data are switched off (menu CAL, CAL CORR OFF). ⇒ switch on CAL CORR ON or PRESET• no valid correction data. This may occur after a cold start of the instrument following a firmware update. ⇒ record correction data• Sweep time too short for current instrument settings (span, resolution bandwidth, video bandwidth). ⇒ increase sweep time
OVLD / IFOVL	OVLD is indicated when the input mixer is overloaded. ⇒ Increase input attenuation IFOVL is indicated when overload occurs in the IF signal path after the input mixer. ⇒ Increase reference level
LOUNL / EXREF	LOUNL is indicated when an error occurs in the frequency processing of the instrument. EXREF is indicated when the analyzer is configured for use of an external reference signal, but no reference signal is detected at the corresponding input.
OVEN	OVEN is indicated when the crystal oscillator (option R&S FSP-B4) has not yet reached its operating temperature. This indication vanishes after a few minutes after switch on.

Trace info:

Every active measurement curve (trace \neq BLANK) is allocated trace information of two or three lines at the left of the diagram. The trace information has the same colour as the measurement curve. The information on the currently selected trace is displayed in inverse video (see *TRACE - SELECT TRACE softkey*).

<n> <detector> <*>
<mode>
<trace math>

n = trace number (1 ... 3)

detector = selected detector

AP: AUTOPEAK detector

PK: MAX PEAK detector

MI: MIN PEAK detector

SA: SAMPLE detector

AV: AVERAGE detector

RM: RMS detector

QP: QUASISPEAK detector

* = indicates that the selected detector does not correspond to that of the automatic coupling.

mode = indication of sweep mode

CLRWR: CLEAR/WRITE

MAXH: MAX HOLD

MINH: MIN HOLD

AVG: AVERAGE

VIEW: VIEW

Trace math = trace math active

1 - 2 trace 1 - trace 2

1 - 3: trace 1 - trace 3

Example:

1 PK *

CLRWR

1-2

Instrument settings
(Enhancement Labels)

Indication of user instrument settings which influence the measuring result and which are not immediately obvious when viewing the measured values.

- * The current instrument setting does not correspond to the one which applied when one of the displayed curves had been stored. This occurs under the following circumstances:
 - The instrument setting is modified while a measurement is being performed.
 - The instrument setting is modified in SINGLE SWEEP mode subsequent to the end of the sweep and no new sweep is started.
 - The instrument setting is modified after setting the trace to VIEW.

The display is retained until the cause is eliminated by the user. I.e., either a new sweep is started (SINGLE SWEEP mode), or the trace of interest is switched to BLANK.

A / B Identification for screen A / B. When screen A / B is activated for the entry of test parameters, this label is highlighted.

SGL The sweep is set to SINGLE SWEEP or SINGLE SCAN.

GAT The frequency sweep is controlled via the *EXT TRIG/GATE* input of the instrument.

TRG The instrument is not triggered in *FREE RUN* mode.

LVL A level offset $\neq 0$ dB has been set.

FRQ A frequency offset $\neq 0$ Hz has been set.

PRN A printer output is active.

75 Ω The input impedance of the instrument is set to 75 Ω .

EXT The instrument is configured for operation with external reference

PA The RF preamplification is switched on.

PS The RF preselection is switched on.

TDF A antenna correction factor (*TRANSDUCER FACTOR*) is switched on.

TDS A set of antenna correction factors (*TRANSDUCER SETS*) is switched on.

Entry fields:**Entry window**

The data entry window is superimposed in the left upper corner of the diagram area, if required. It covers the display of the title and the time. The field is used to enter numeric or alphanumeric device parameters.

Tables

The tables are superimposed in the diagram area, if required. They are used for displaying and configuring device parameters.

Message windows:**Message field**

Message fields provide notes on measurements, e.g. results of the limit check (PASS/FAIL). These notes are no error messages, which are indicated as system messages.

They can be masked out by pressing the *ESC* key.

System messages

System messages indicate warnings and error messages.

Message without action field:

These system messages contain only arbitrary information. They hint at events which are of interest for the user but do not affect the measurement or functioning of the instrument.

They are deleted either automatically after a predefined time has passed (3 seconds) or upon any keystroke or mouse click.

Message with action field:

These system messages require a decision to be taken by the user. They are not deleted until any action has been selected. Deletion of the message initiates the action selected and appropriate measures to be taken. The action field consists of one (OK), two (OK/CANCEL) or three (arbitrary) buttons.

The user may select one of the buttons using the cursor keys and initiate the associated action by means of the unit keys. The *ESC* key is used to acknowledge the message without releasing any action.

Traces:**1 to 3**

Up to 3 traces in each measurement diagram can be displayed simultaneously.

Limit lines

Limit lines are used to mark level curves or spectral distributions which must not be exceeded or dropped below.

The R&S ESCI provides two display modes:

- Full Screen: 1 window, the measurement is performed in the active diagram.
- Split Screen: 2 windows, the measurements are performed in both diagrams.

Full Screen

In the full-screen mode, the settings and measurements are performed in the active visible window. All indications on the screen refer to this window. The designation (SCREEN A or SCREEN B) is inserted as enhancement label A or B on the right diagram margin.

Switching between the windows is by means of *SCREEN A/B* hotkey. The current measurement is terminated when its window is blanked out.

Switching from split-screen to full-screen mode is performed in menu *DISP*.

Split Screen

In Split Screen mode, the screen is divided into two halves.

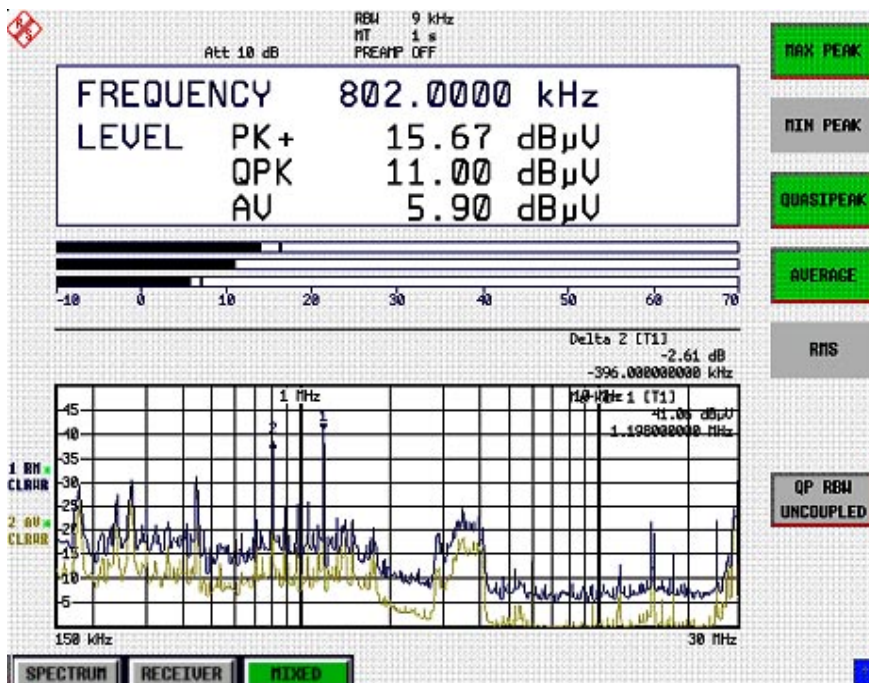

Fig.3-4 Subdivision of the screen in Split Screen mode

In the receiver mode, the screen is divided up according to fixed configurations.

Table 3-1 Default assignment of traces to windows with split screen in the receiver mode

upper (screen A)	Indication of level and frequency
lower (screen B)	Scan spectrum

In analyzer mode, the upper half is assigned Screen A, the lower one Screen B. The settings for measurement can be selected independently for both screens. E.g., a spectrum may be displayed in Screen A and a time amplitude in the time range is displayed in Screen B.

In the MIXED mode, the screen is split according to fixed configurations.

Table 3-2 Assignment of windows with split screen in the MIXED receiver mode

upper (screen A)	Level and frequency display
lower (screen B)	Analyzer spectrum

or

upper (screen A)	Analyzer spectrum
Lower (screen B)	Scan spectrum

Displays that apply to only one measurement diagram appear at the edge of the diagram in question. Displays that apply to both windows appear between the diagrams.

The *SCREEN A/B* hotkey is used to select the diagram for which the input of measurement parameters or the operation of markers is valid. Measurements are performed simultaneously in both measurement diagrams, regardless of which is currently active.

Switching from full-screen to split-screen display is done via the *DISP* menu.

Softkey Area

The softkeys are assigned to the nine keys on the right side of the display

The setup of the softkey area is independent of the operating mode. It consists of the following graphic elements:

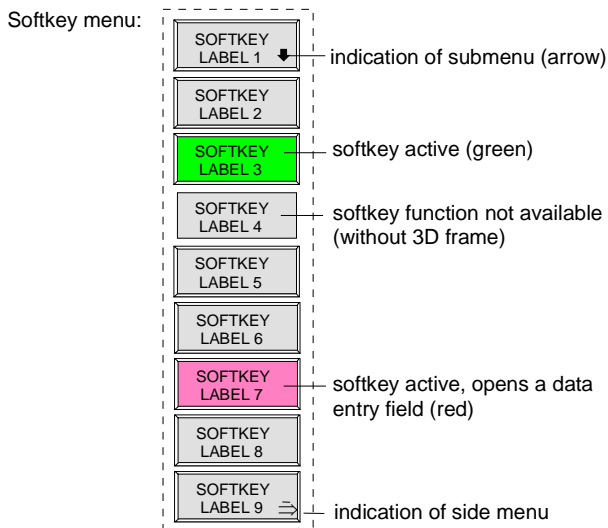

Fig.3-5 Setup of the softkey area

The softkeys have different functions depending on the instrument state. Therefore, their labeling can be varied. The labeling of all softkeys which call a submenu includes a ↓ arrow.

The function and current state of the softkeys is indicated in the label by different texts and colors. The color assignment is factory-set as follows:

Table 3-1 Factory-set color assignment of soft keys

Softkey color	Meaning
gray	Softkey switched off
green	Softkey switched on
red	Softkey switched on and data entry active

These colors can be changed by the user as desired in the *DISP - CONFIG DISPLAY* menu.

A softkey is switched on or off by pressing the respective hardkey (see following section "Setting the Parameters").

Softkeys are masked out, too, if the functionality which they represent is not available. A distinction has to be made between two cases:

- If an instrument function depends on an option, and if this option is not fitted, the associated softkey is masked out,.
- If the instrument function is not available temporarily due to specific settings, the softkey is displayed without the 3D frame.

The label  on the right lower corner of the softkey area indicates that a side menu is available. The side menu is called by pressing the *NEXT* key.

Hotkey Area

Hotkeys are allocated to the eight keys on the bottom margin of the screen. They change between modes and the active diagrams.

The menu only shows the hotkeys which are actually used:

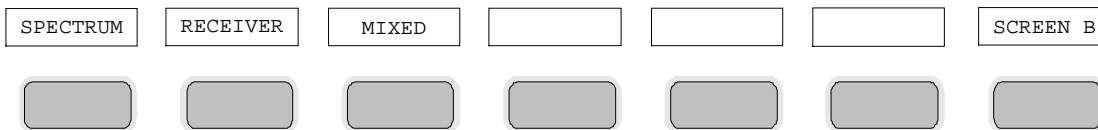

A keystroke activates the associated hotkey. An activated hotkey changes its frame:

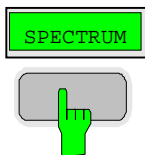

Calling and Changing the Menus

The operation of the spectrum analyzer is menu-controlled via keys and softkeys. Various softkey menus are displayed depending on the instrument status. The individual menus constitute the so-called menu tree. The top menu (the root of the menu tree) is always called by means of a keystroke. Arrows at the lower edge of the softkey area indicate whether a supplementary menu can be entered or not.

Softkeys with an arrow allow for branching into further menus (so-called submenus): The field "↵" at the lower right side of the softkey area indicates that this menu has a side menu.

The menu change keys on the front panel below the softkey area allow for switching between the main menu and the side menus and submenus.

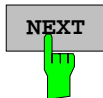

The *NEXT* key calls the side menu.



The *PREVIOUS* key returns to the next higher menu.

Several menus provide for automatic change, i.e., return to the next higher menu is caused automatically after pressing a softkey.

Selection of a submenu is always effected via a softkey.

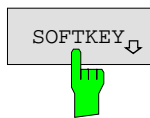

The labeling of all softkeys which call a submenu includes a ↵ arrow.

Setting Parameters

Parameters are set either by simple selection (selection parameters) or by (alpha)numeric entries in data entry windows or tables.

The numeric keypad on the front panel, an external keyboard (optional), a spinwheel and the cursor keys are provided for the entry of instrument parameters in an entry window or in a table.

The external keyboard is optional. If it is not fitted, the help line editor is called automatically for entry of alphanumeric parameters. The help line editor provides for selection of individual letters and a number of special characters which are copied into the actual entry window.

Numeric Keypad



The numeric keypad is provided for entry of numeric parameters. It contains the following keys:

- Number keys 0 to 9
- Decimal point
Inserts a decimal point "." at the cursor position.
- Sign key
Changes the sign of the mantissa or exponent of a numeric parameter.
A "-" is inserted at the cursor position in case of an alphanumeric parameter.
- Unit keys (*GHz/-dBm*, *MHz/dBm*, *kHz/dB* and *Hz/dB*)
 - Provide the numeric value entered with the selected unit and terminate the entry.
The unit keys are all assigned the value "1" for dimensionless quantities or for level entries (e.g., in dB). The unit keys thus assume the function of an *ENTER* key. The same applies for an alphanumeric entry.
 - Open and close the selection windows of tables.
- *BACK* key
 - Deletes the character left to the cursor with numeric entry.
 - Allows for toggling between the current and the previous values subsequent or prior to entry (UNDO function).
- *ESC/CANCEL* key
 - Aborts the entry before it has been terminated. The previous value is restored.
 - Closes the entry field after termination of input.
 - Closes system messages.
- *ENTER* key
 - Terminates the input of dimensionless quantities. The new value is set.

Note: The *ENTER* keys assumes the function of the *Hz* key for frequency input, and the function of the μ s(*kHz*) key for time input.

Spinwheel and Cursor Keys

The spinwheel and the cursor keys are arranged besides the numeric keypad.

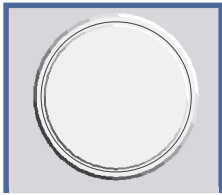

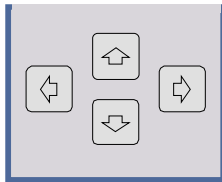

The spinwheel has various functions:

- With numeric entry, the instrument parameter is incremented (turning clockwise) or decremented (turning counterclockwise) at a defined step size.
- In tables, the spinwheel can be used to shift the cursor horizontally or vertically when no entry window is open. The direction (horizontal/ vertical) is switched over using the cursor keys.
- The spinwheel is used with the help-line editor to select the individual letters.
- It can be used to shift markers, display lines, limit lines etc.
- Pressing the spinwheel terminates the input of parameters.



In tables, the cursor keys are used to shift the cursor between the lines and columns of the table.

The keys  and  are used to shift the cursor inside the entry window to reach a particular position in the string.

The keys  and 

- increase or decrease the value of a parameter for numeric input .
- switch between editing line and help line editor for alphanumeric input.

Selection and Setting of Parameters via Keys or Softkeys

The selection of parameters and their settings is effected by means of a key, a softkey or in a table depending on the hierarchical level of the menu they are assigned to. Selection and setting of parameters in tables is described in section "Selection and Setting of Parameters in Tables".

Selection via key

Most keys of the network analyzer are used to enter menus where the selection and the settings are made. Few settings can be made directly by means of a keystroke, only.

Example: Call up of preset settings

- Press *PRESET* key

The spectrum analyzer is brought into a predefined initial state.



Selection via softkey

In most cases the selection is made by pressing the respective softkey. There are various alternatives of making the selection:

1. The softkey is active or inactive.

Example: Switching on/off the frequency counter

- Press *MKR* key.
- Press *SIGNAL COUNT* softkey.

Each time the softkey is pressed, the marker info list is switched on or off. If the softkey is active (= marker info list on), it is illuminated.

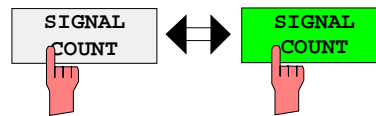

2. The softkey acts like a toggle switch, each pressing changes the active selection.

Example: Selection of the reference (internal or external)

- Press *SETUP* key.
- Press *GENERAL SETUP* softkey, the *GENERAL SETUP* submenu is opened.
- Press *REFERENCE INT/EXT* softkey.

With each pressing, the checkmark on the softkey changes from INT (internal reference) to EXT (external reference) and vice versa. When in the active setting the softkey menu item is illuminated.

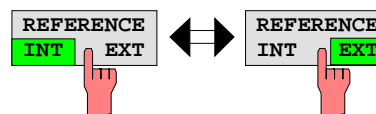

- 3. Various softkeys act like selection switches. Only one softkey may be active at a time.

Example: sweep setting

- Press *SWEEP* key.
- Press *CONTINUOUS SWEEP* softkey.

The continuous sweep is thus set. The *CONTINUOUS SWEEP* softkey is colored (factory-set: green). The second alternative, a series of n sweeps according to the trigger definition, can be selected via the *SINGLE SWEEP* softkey in the same menu. Only one of the two softkeys can be active at a time, the softkeys thus act like selection switches.

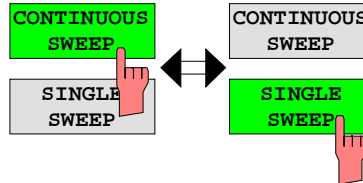

- 4. The softkey is used to select the parameter, the setting is made in an alphanumeric data entry window.

Example: SWEEP COUNT parameter

- Press *SWEEP* key
- Press *SWEEP COUNT* softkey.

The window for entering the number of sweeps for the *SINGLE SWEEP* mode is opened. The softkey is colored (factory-set: red). (Data entry is described in the next section).

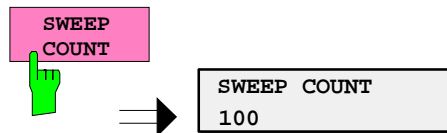

4. The softkey is used to select the parameter, the setting is made in an (alpha)numeric data entry window. The softkey function is switched on. To switch off the function, the softkey has to be pressed again.

Example: parameter MARKER

- Press *MRK* key.
- Press *MARKER 1* softkey.

The window for entering the marker frequency is opened. The softkey is colored (factory set: red). Marker 1 is switched on and the peak search is started.



- Press *MARKER 2* softkey.

The entry window for the marker frequency of marker 2 is opened. The softkey is colored (red), marker 2 is switched on, and the *MARKER 1* softkey turns green.

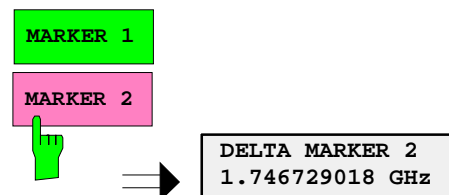

- Press *MARKER 1* softkey again.

Marker 1 is switched off.

5. The softkey selects the parameter, the setting is made in a selection table.

Example: Selection of the sorting criteria of a file list

- Press *FILE* key.
- Press *FILE MANAGER* softkey.
- Press *SORT MODE* softkey.

A selection table is displayed. The softkey is colored (factory-set: red). (operation see below).

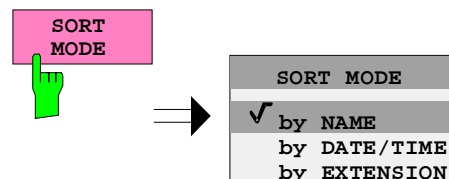

Editing of Numeric Parameters

The entry of numeric values is always made in a data entry window, which is displayed automatically after selection of the parameter.

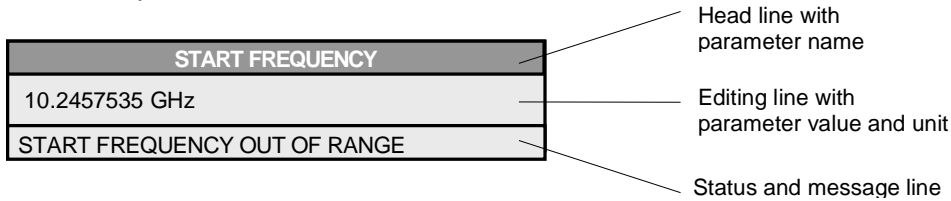

The headline indicates the name of the instrument parameter, which has been selected. The entry is made in the editing line. Subsequent to calling the entry window, the current parameter value including the unit is displayed left-justified in the editing line. Status and error messages which refer to the current entry are displayed in the third and (optionally) fourth line.

Note: Entry windows may be represented transparent (cf. DISPLAY - CONFIG DISPLAY menu)

Entry of a numeric value

- Call data entry window (cf. selection of parameters)
The editing line indicates the current value

Example: center frequency (frequency-sweep mode)

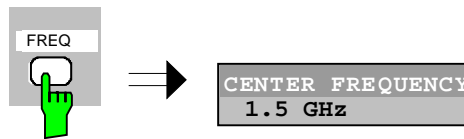

Entry via number keys

- Enter required value via number keys.

Example:

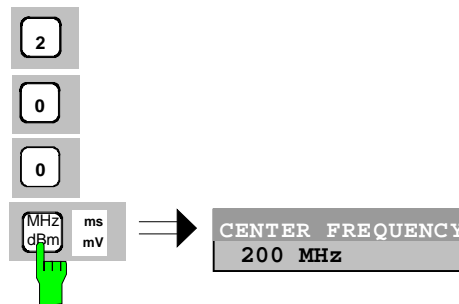

Entry via cursor keys

- Cursor or until obtaining the required value.

Example:

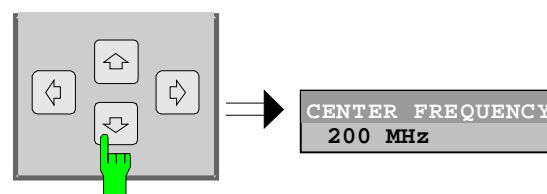

- Entry via spinwheel
- Rotate the spinwheel until reaching the required value.
The variation step size increases with increasing rotational speed.
 - Turning the spinwheel clockwise increases the value, turning it counterclockwise decreases the value.

Example:

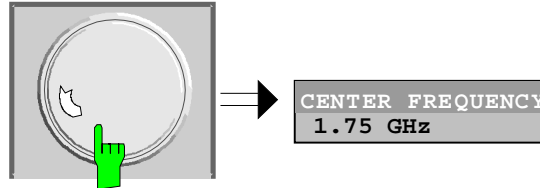

Note: When the value is modified by means of the spinwheel or the cursor keys the new value is immediately set.

Terminating the entry

- Press one of the unit keys
The unit is entered in the entry window and the new setting is accepted by the instrument.

For dimensionless quantities:

- Press the ENTER key or the spinwheel
The new setting is accepted by the instrument.

A few data entry windows close automatically whereas others like the entry window for the start frequency remain open even after termination of the entry. They can be closed by pressing the *ESC* key.

If an error occurs, a corresponding error message is displayed in the status line of the entry window, e.g., "Out of range", "Value adjusted", etc. In this case, the new value is not accepted for the instrument setting.

Example:

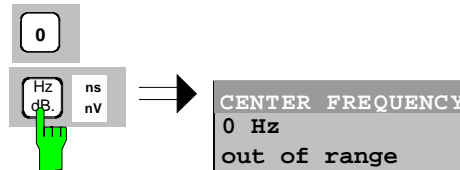

Correcting the entry

- Deleting an entry
- Position the cursor beside the digit which is to be deleted using the cursor keys \leftarrow or \rightarrow .
 - Press the *BACK* key. The entry left to the cursor is deleted.
 - Enter new numbers. The number is inserted to the left of the cursor, the other numbers are shifted right.

Restoring the original value

- Press the *BACK* key

For numerous parameters, the data administration of the instrument stores the previously valid parameter value in addition to the current value. The *BACK* key can be used to toggle between these two values. This applies for terminated entries as long as the data entry window is displayed.

Aborting the entry

- Press *ESC* key

The original parameter value is restored. The new entry is deleted.

- Press *ESC* key again

The entry window is closed, the original value remains active.

or

- Press any key or any softkey (even the softkey which has opened the entry window).

The entry is aborted and the entry window is closed. The original value remains active.

Entry of Alphanumeric Parameter

A help-line editor or an external keyboard (optional) are provided for the entry of alphanumeric instrument parameters.

The spinwheel and the exponent key have no function with alphanumeric entry. All unit keys assume the function of an ENTER key.

The entry is always made in a data entry window which is displayed automatically upon selection of the parameter. The editing line comprises 60 characters. Up to 256 characters may be entered. If a text exceeds 60 characters the contents is shifted automatically 20 characters left or right when the left or right margin of the editing line is touched by the cursor.

Editing with External Keyboard

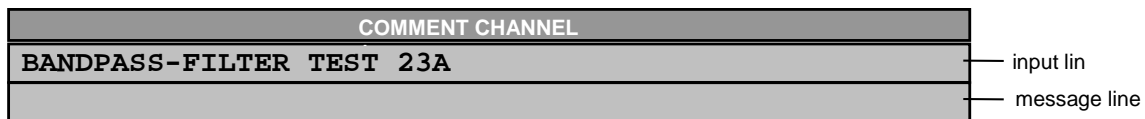

Entry of text

- Select parameter.
The data entry is active automatically upon calling the data entry window. The cursor is positioned at the beginning of the previous entry.
- Press the required character on the keyboard.
The character is inserted prior to the cursor.
- Enter further characters

Correcting the entry

- Delete the entry using the *DELETE* key or *BACKSPACE* key.

Terminating the entry

- Press the *ENTER* key of the external keyboard
The data entry window is closed and the new value is accepted for the instrument.

Aborting the entry

- Press the **ESC** key on the front panel
- or
- any softkey.
- The data entry window is closed, the original value is retained.

Editing with Help Line Editor

If the external keyboard is not fitted, the help line editor is called automatically with entry of alphanumeric parameters. The help line editor is an extension of the alphanumeric entry window. It contains the complete alphabet with uppercase and lowercase letters as well as special characters in two lines of 52 characters, each. Individual letters and a series of special characters can be selected in the help line editor and copied into the entry line.

The help line editor comes in two versions:

Version 1:

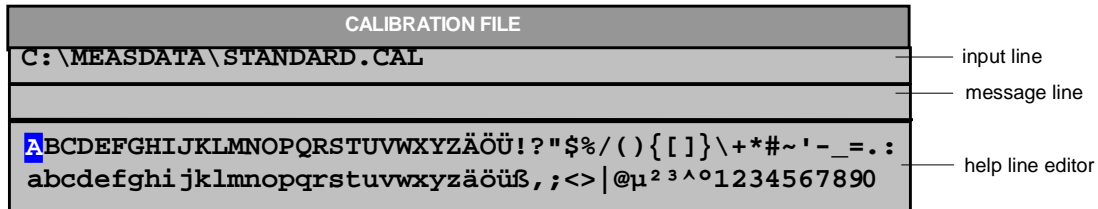

The cursor keys or toggle between entry in the editing line and selection in the help line editor.

Entry of text

- Select parameter.
The data entry is active automatically upon calling the data entry window. The cursor is positioned on the left in the editing line.
- Position the cursor in the help line editor using the cursor key.
The cursor marks the first letter of the editor.
- Locate the cursor on the character which is to be entered into the editing line using the cursor keys or or the spinwheel.
- Press the *ENTER* key or the spinwheel.
The character is entered in the editing line.

Correcting the entry

- Locate the cursor in the editing line using the cursor key .
- Position the cursor after the character which is to be deleted using the cursor keys and .
- Press the *BACK* key.
The entry left to the cursor is deleted.

Terminating the entry

- Locate the cursor in the editing line using the cursor key .
- Press any unit key or the spinwheel.
The data entry window is closed, the new entry is accepted by the instrument.

Aborting the entry



- Press the *CLR* key.
The data entry window is closed, the previous entry is retained.

Version 2:





													1	2	3	4	5	6	7	8	9	0
A	B	C	D	E	F	G	H	I	J	K	L	M	:	\	.	/	^	+	-	=	,	
H	O	P	Q	R	S	T	U	V	W	X	Y	Z	<	>	()	{	}	[]	#	~
a	b	c	d	e	f	g	h	i	j	k	l	m	'	@	;		?	!	"	€	\$	%
n	o	p	q	r	s	t	u	v	w	x	y	z	«	»	BACK	EXIT						
SPACE																						

The entry area consists of two parts:

- the editing line
- the character selection field





The cursor keys  or  are used to toggle between entry in the editing line and the character selection field .

Entry of text

- Select parameter.
The data entry is active automatically upon calling the data entry window. In tables, the help line editor is accessed by the cursor key  .
In the editing line, the cursor is positioned at the beginning of the current entry.
- Position the cursor to the character selection field using the cursor key  .
The cursor highlights the first letter of the editor.
- Position the cursor to the character to be entered in the editing line by means of the cursor keys  or  or the spinwheel.
- Press the *ENTER* key or the spinwheel.
The character will be entered in the editing line.

Correcting the entry (Version 1)

- Move to the character << in the character selection field using the spinwheel.
- Position the cursor behind the character to be deleted by moving and pressing the spinwheel on << and >>.
- Move to the *BACK* field using the spinwheel and press the spinwheel.
The entry to the left of the cursor in the editing line will be deleted.

- Correcting (Version 2)** **the entry** ➤ Position the cursor to the editing line by means of the cursor key  .
- Position the cursor after the character to be deleted by means of the cursor keys  and  or with the spinwheel.
 - Press the *BACK* key.
The entry to the left of the cursor will be deleted.
- Terminating (Version 1)** **the entry**
- Select the EXIT field using the spinwheel and press the spinwheel.
The data entry window will be closed; the new entry will be accepted by the instrument.
- Terminating (Version 2)** **the entry** ➤ Move the cursor to the editing line using the cursor key  .
- Press one of the unit keys or the spinwheel.
The data entry window will be closed; the new entry will be accepted by the instrument.
- Interrupting the entry**
- Press the *ESC* key.
The data entry window will be closed; the previous entry will be retained.

Selection and Setting of Parameters via Tables

The spectrum analyzer uses numerous tables for display and configuration of instrument parameters.

The tables differ considerably in the number of lines, columns and inscriptions. The basic steps of operation for the selection and setting of parameters are, however, the same for all tables. Shown below is the typical entry of parameters into a table.

Note:

Most of the tables are coupled to a softkey menu which provides further functions for editing table entries such as deletion of tables, copying of lines or columns, marking of table elements, restoring default states.

The definition of individual tables and the operation of particular editing functions can be looked up in the description of the corresponding softkey menu.

1. Activating the table

- If the menu has only one table, the latter is activated automatically subsequent to calling this menu in most cases and the marking cursor is positioned to the top field of the left column.
- If the menu contains various tables, the table of interest must be selected using the softkey which is labeled with the title of the table.

2. Selection of the parameter

LIMIT LINES				
NAME	COMPATIBLE	LIMIT CHECK	TRACE	MARGIN
GSM22UP	✓	off	1	0 dB
✓ LP1GHz		on	2	0 dB
✓ LP1GHz	✓	off	1	0 dB
MIL461A		off	2	-10 dB

marking cursor
↓

Selection of the parameter (or the setting) is made using the marking cursor.

- Press the cursor keys to move to the wanted field.

or

- Rotate the spinwheel until the wanted field is marked. The cursor keys are used to specify the direction of the spinwheel movement (horizontal or vertical)

When shifting the cursor, elements may be skipped which can not be edited. Table elements, which can not be selected are indicated by a different color.

- Press the *ENTER* key or the spinwheel.
The parameter/the setting has been selected.

The selected parameter can be edited the way described below:

3. Editing the marked parameter

LIMIT LINES				
NAME	COMPATIBLE	LIMIT CHECK	TRACE	MARGIN
GSM22UP	✓	off	1	0 dB
✓ LP1GHz		on	2	0 dB
✓ LP1GHz	✓	off	1	0 dB
▲ MIL461A		off	2	-10 dB

checkmark

TRACE
1
✓ 2
3

MARGIN
-10 dB

a) Toggling between two states

If an element of a table can be switched on and off only, the unit keys are used to toggle between these two states.

- Press one of the unit keys.
The table element is switched on and provided with a checkmark. (✓).
 - Press one of the unit keys once more.
The table element is switched off.
- or
- Press one of the unit keys.
The table element is switched on, "on" is displayed.
 - Press one of the unit keys once more.
The table element is switched off, "off" is displayed

b) Opening a data entry window

If a table entry consists of an (alpha-) numeric value, the corresponding entry window will be opened after selecting the numeric value by pressing the *ENTER* key or the spinwheel.

Note 1: For numeric instrument parameters, the editing operation may be started by entering any number or letter on the front panel or on the external keyboard. In this case, the data entry window is opened automatically.

Note 2: For alphanumeric table fields for which the help line editor version 2 is required, the help line editor will be opened by pressing the *CURSOR DOWN* key after *ENTER*.

c) Opening a selection table

If a table entry may have various states (e.g., colors from a color pallet, fixed filter bandwidths, etc.), a table indicating all possible states is displayed with selection. The current state is and marked by a checkmark and by the cursor.

- Set the cursor to the desired setting.
- Press one of the unit keys.
The setting is switched on and marked (√). The selection table closes and the value is transferred to the original table. The cursor is positioned automatically on the next table element.

Abortion of entry

- Press the *ESC* key.

The current entry/selection is aborted and the original setting is restored.

Scrolling

Some tables contain more entries than can be displayed on one screen page. In this case, a **scrollbar** is displayed at the right margin of the table, whose slider shows the current position in the text.

- Actuate the *PAGE UP* or *PAGE DOWN* softkeys.

The table is paged forward or back by one page.

- Press cursor key  or .

The table is scrolled up or down by one line.

Menu Overview

The following section gives a graphical overview of the R&S ESCI menus. Side menus are marked by an arrow directed to the left/right, submenus by an arrow showing upwards.

The menus appear in the order corresponding to the arrangement of keys on the front panel. The available hotkeys and the LOCAL menu appearing during the remote control of the instrument are also displayed.

The functions of menus are described in detail in Chapter 4. The IEC/IEEE-bus command associated with each softkey is indicated. In addition, the softkey list at the of Chapter 6 gives the assignment of IEC/IEEE-bus commands to softkeys.

FREQ Key

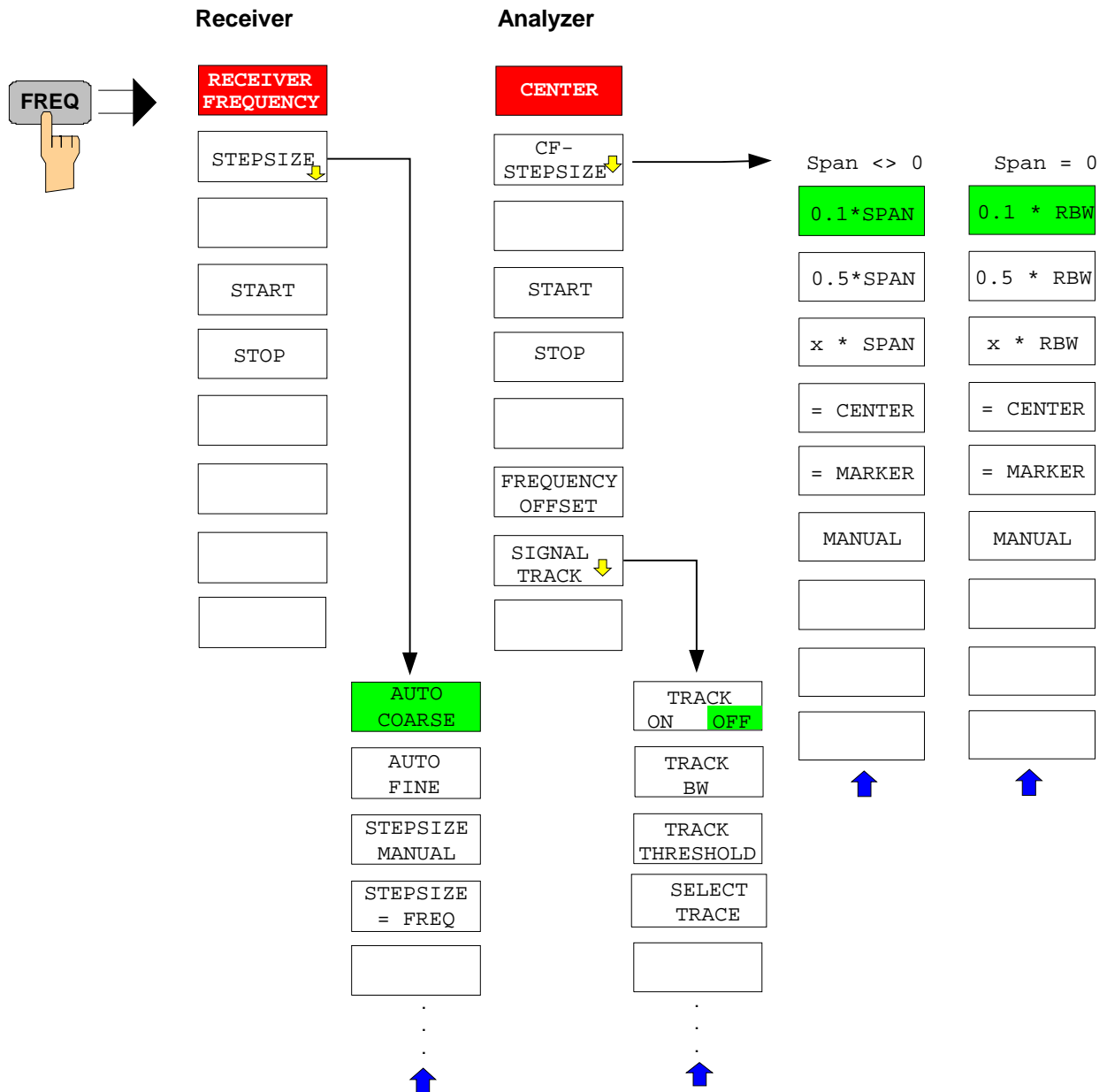

SPAN Key

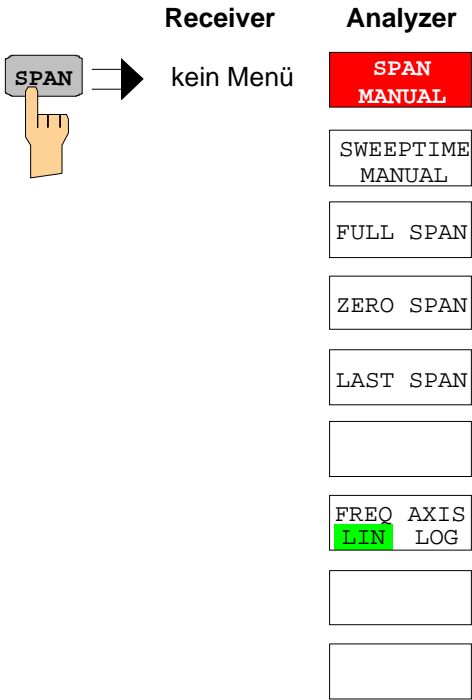

AMPT Key

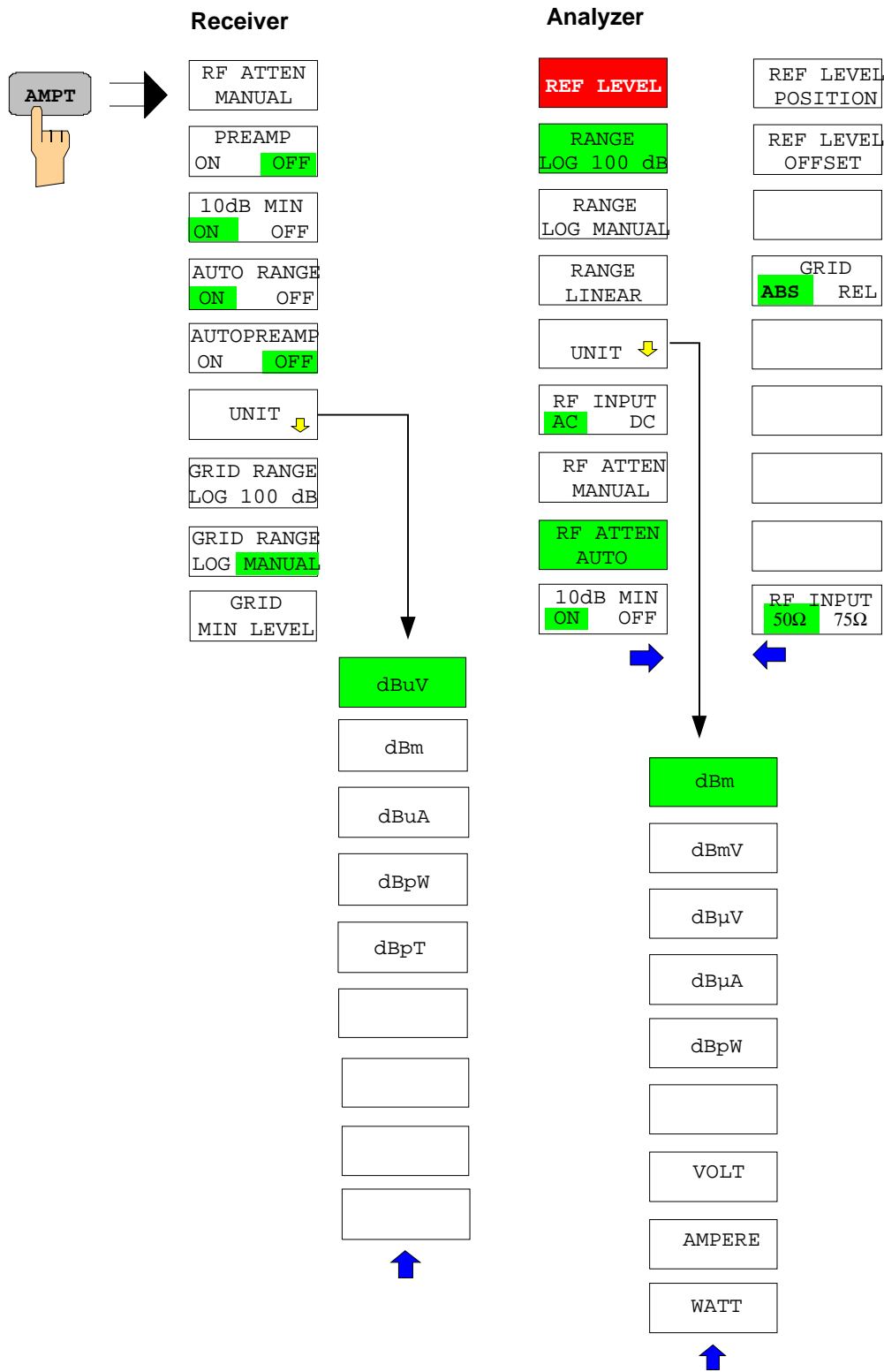

MKR Key

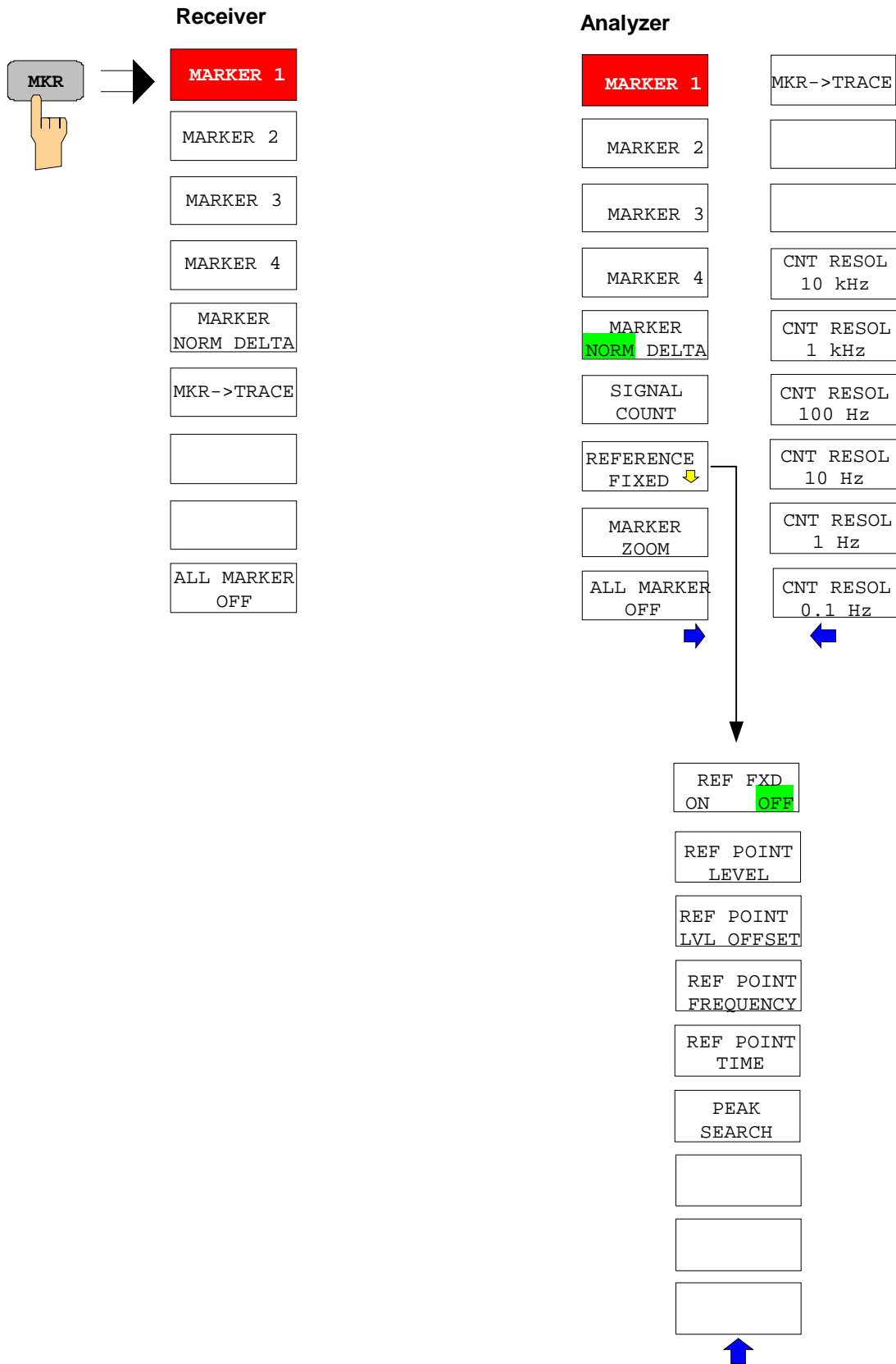

MKR-> Key

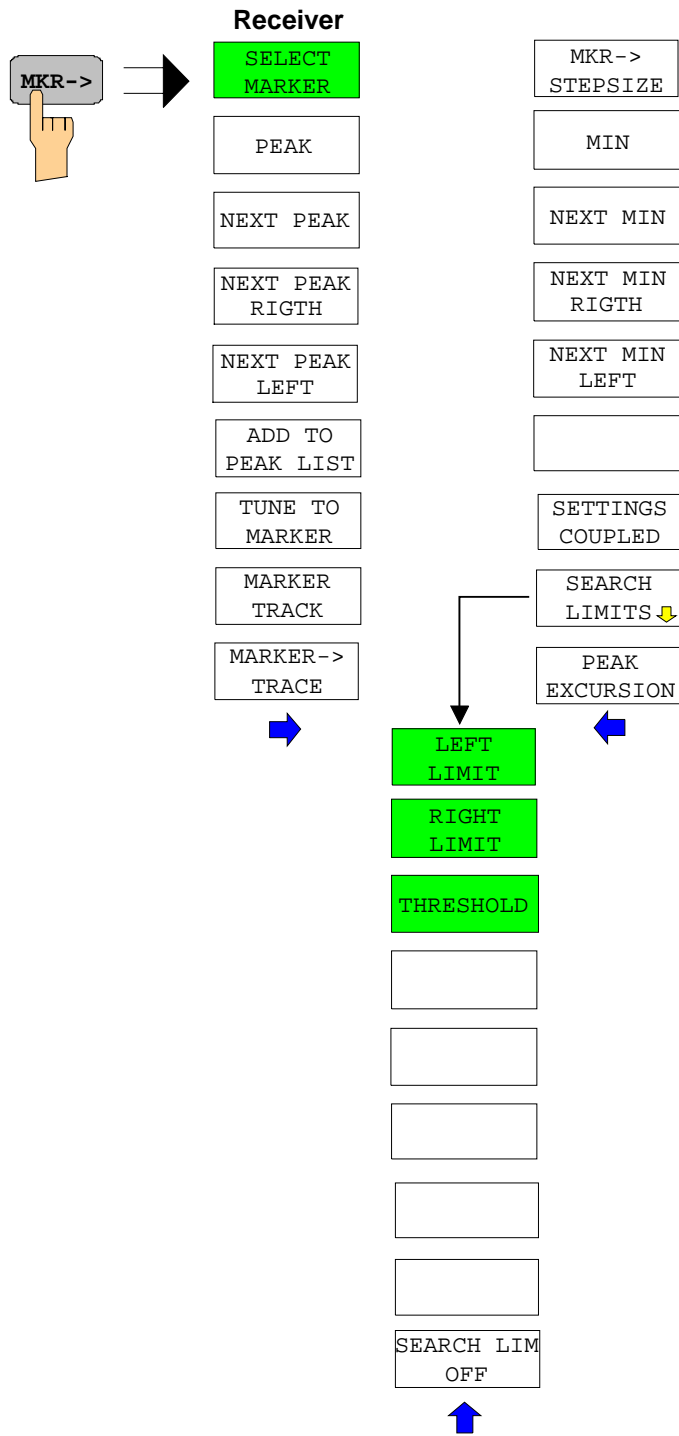

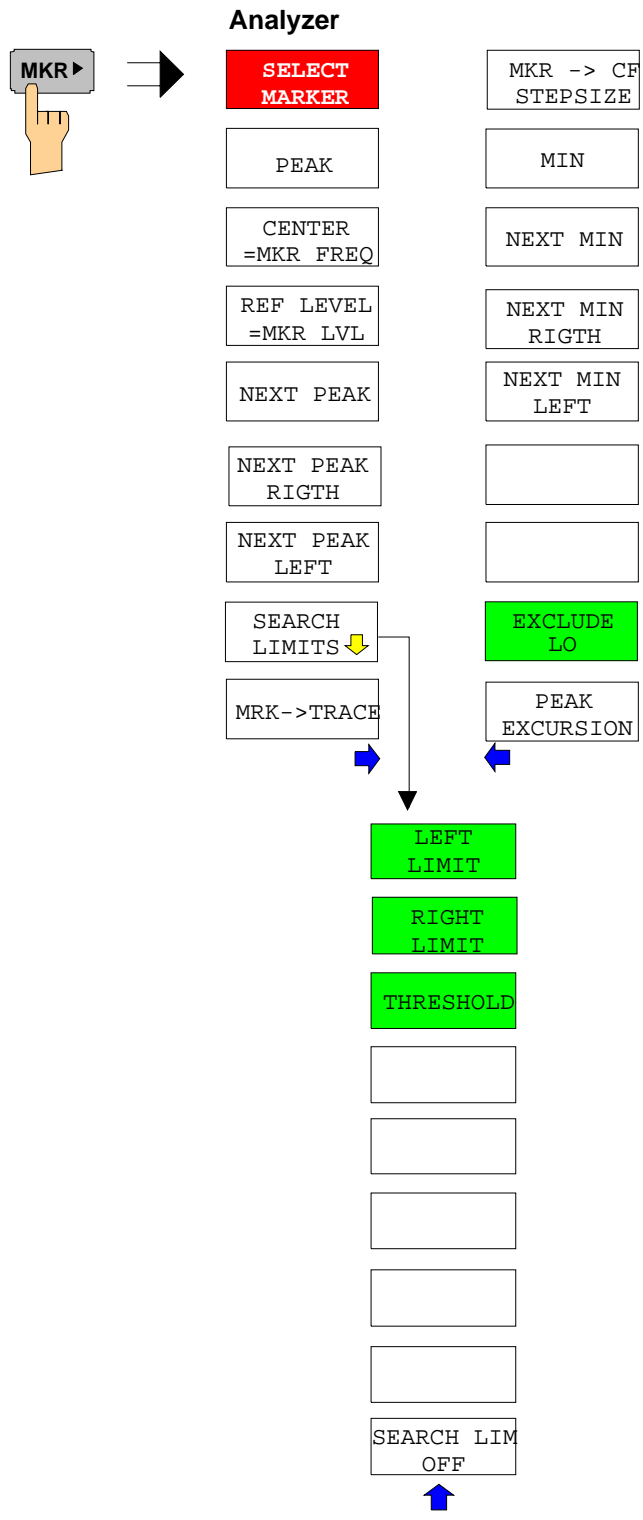

MKR FCTN Key

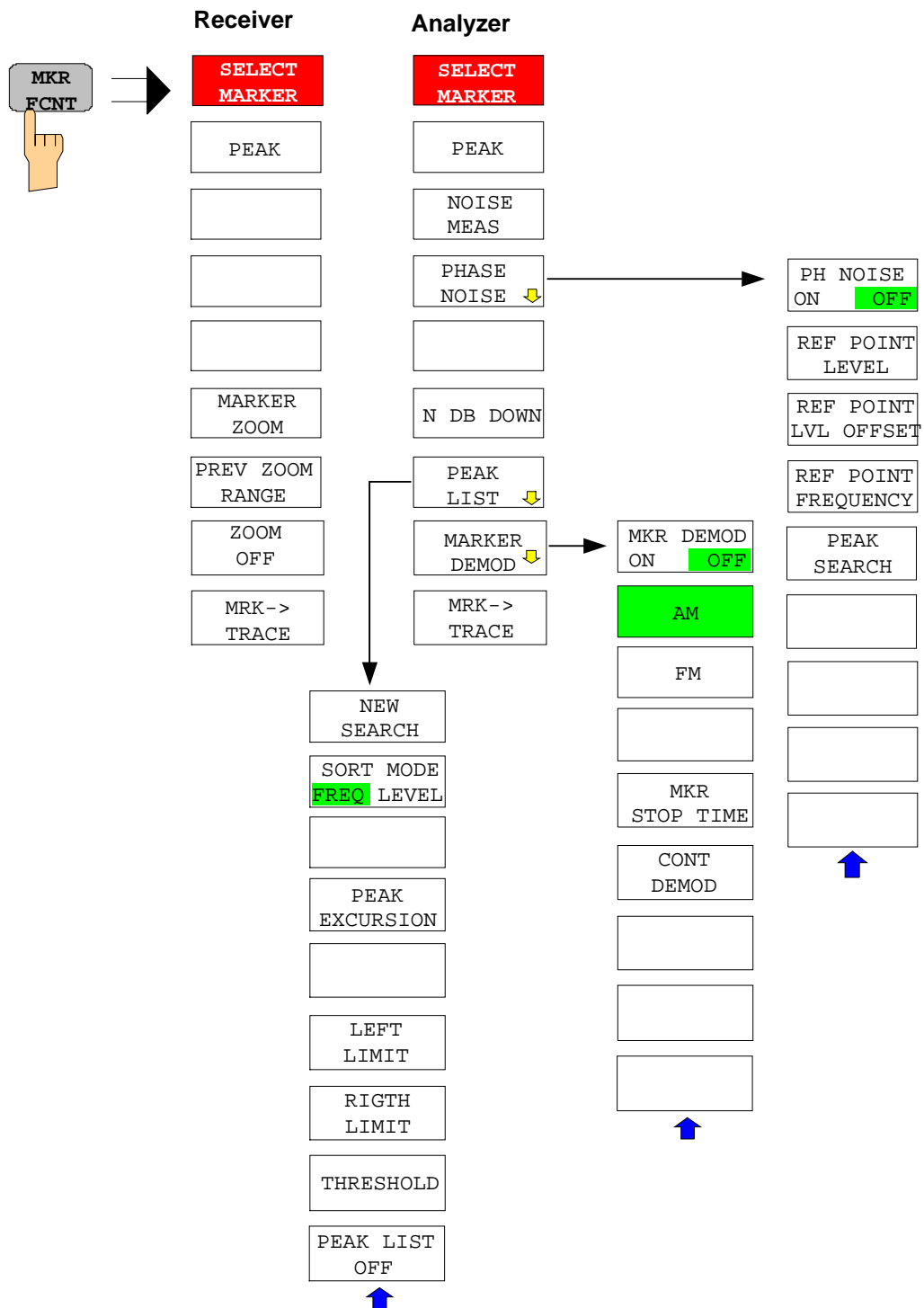

BW Key

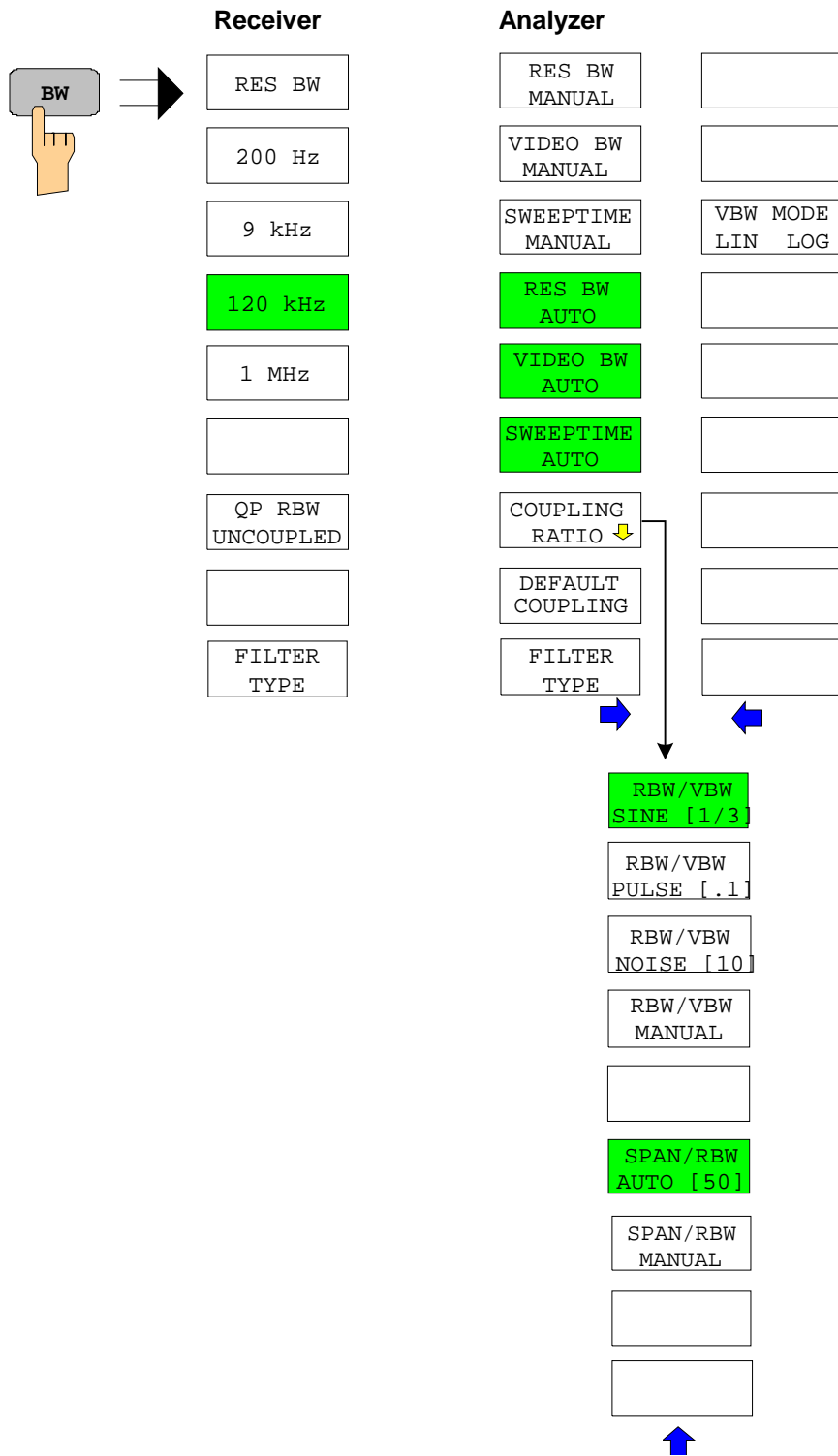

SWEEP Key

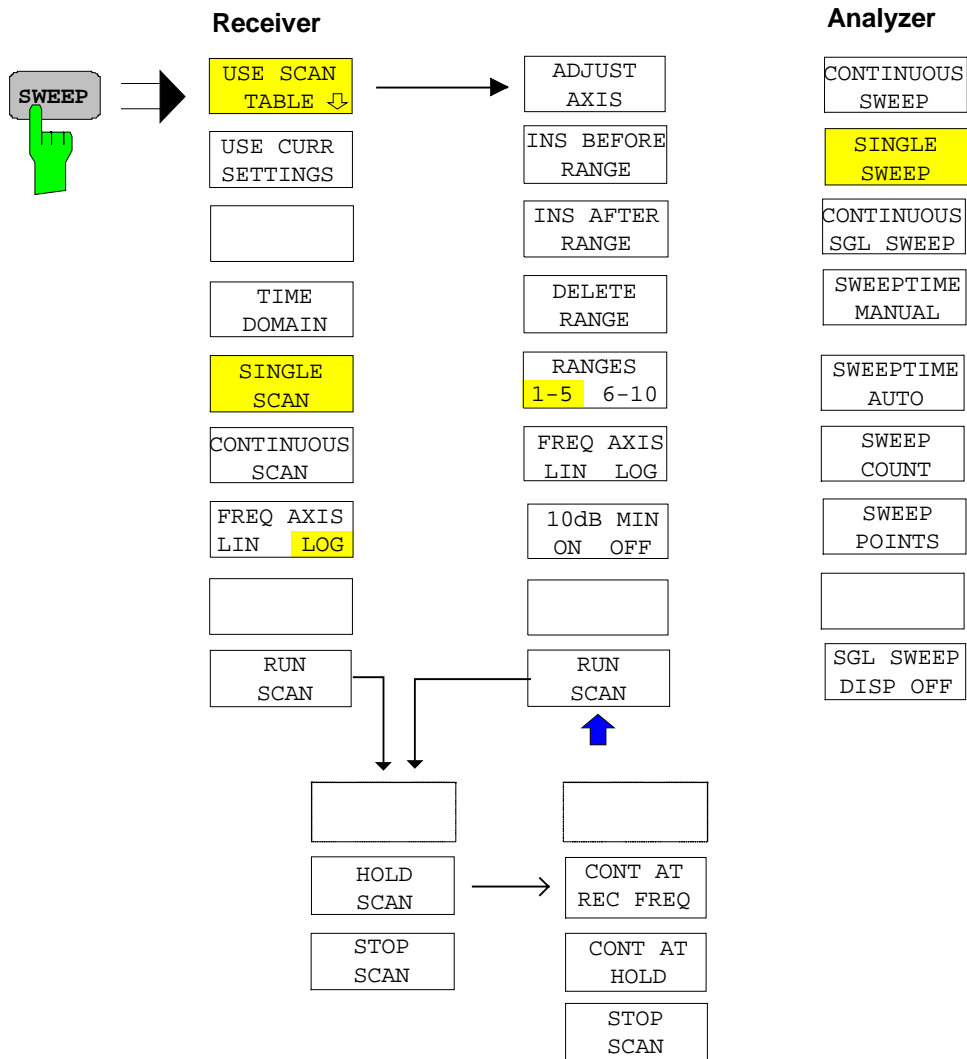

MEAS Key

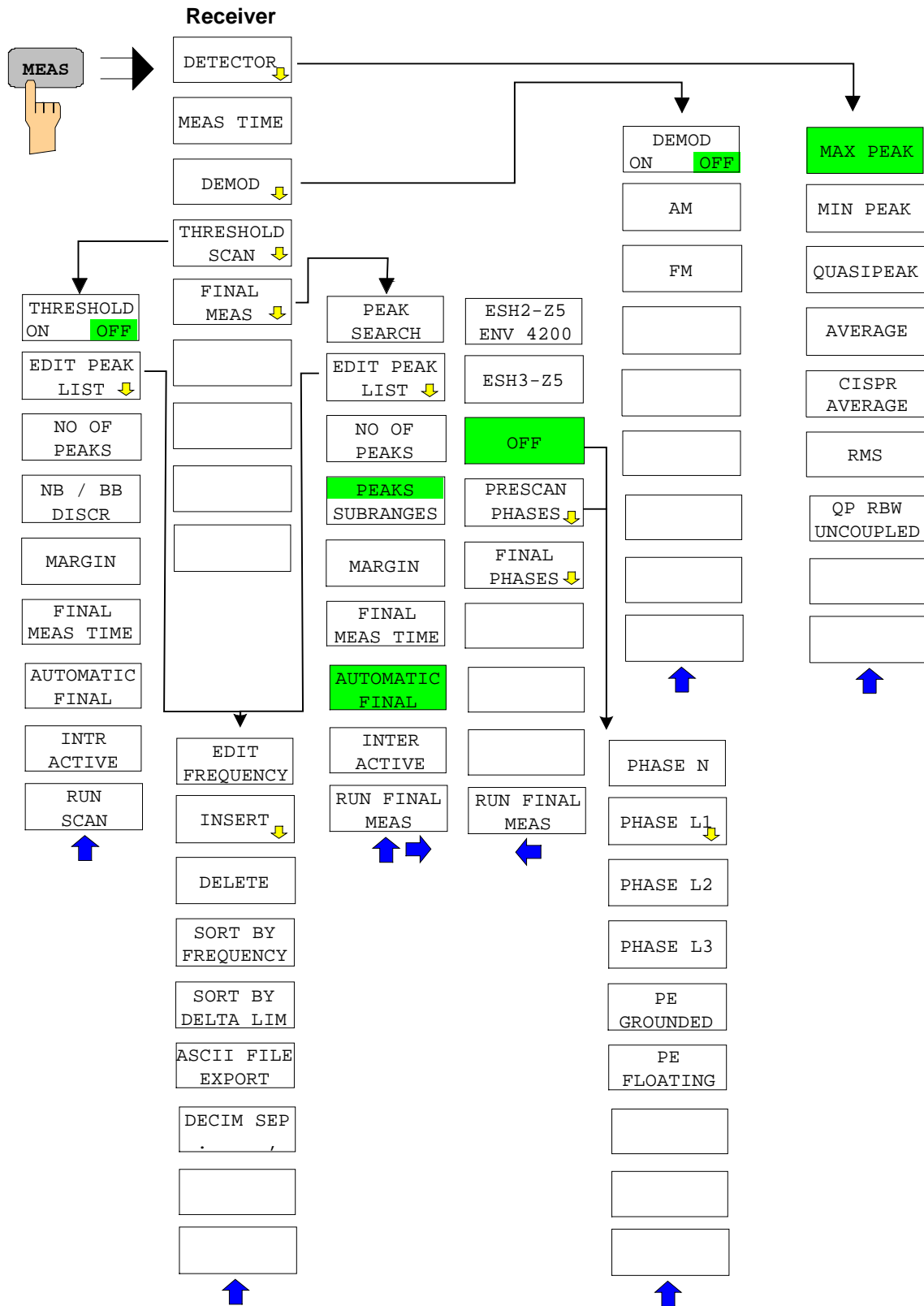

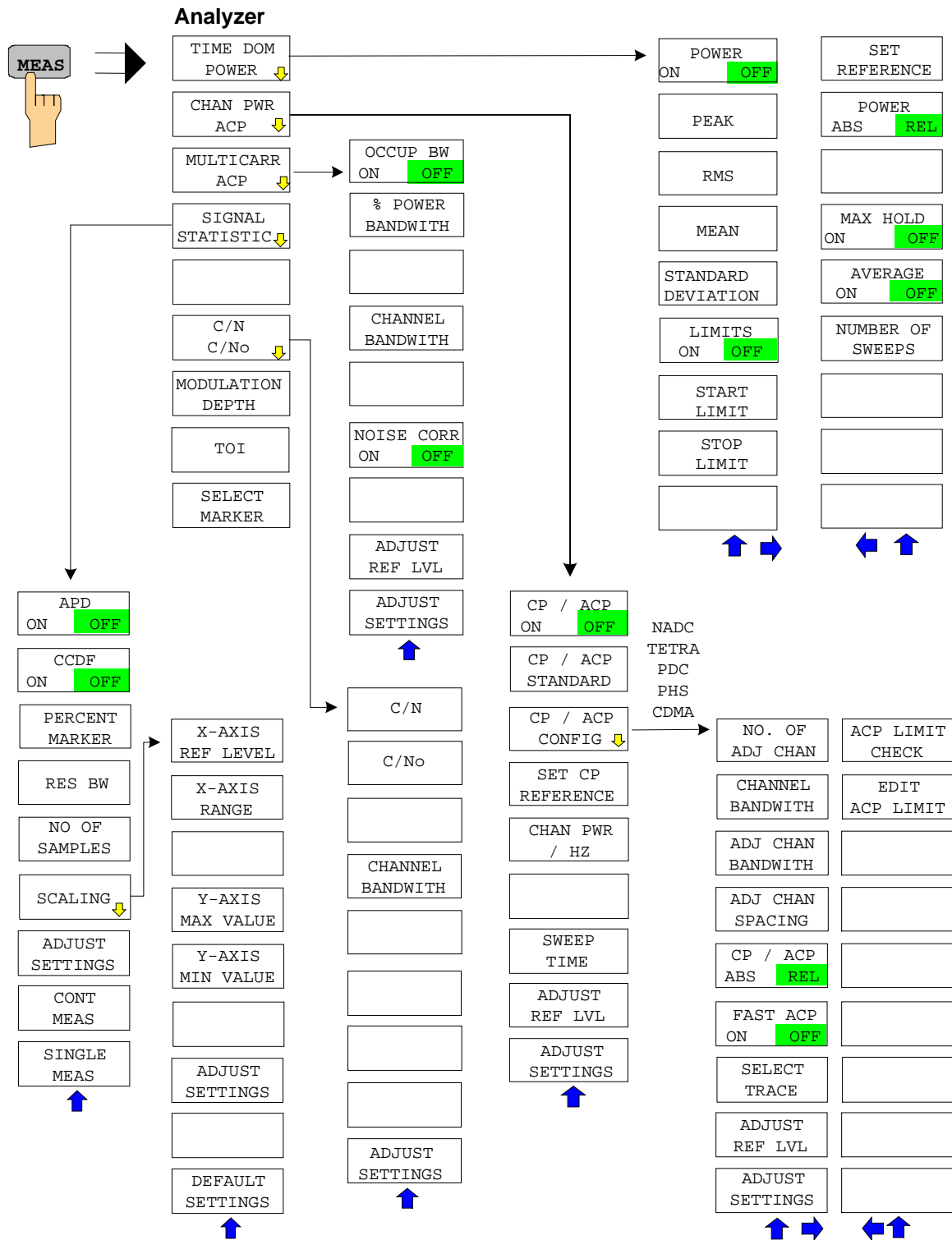

TRIG Key

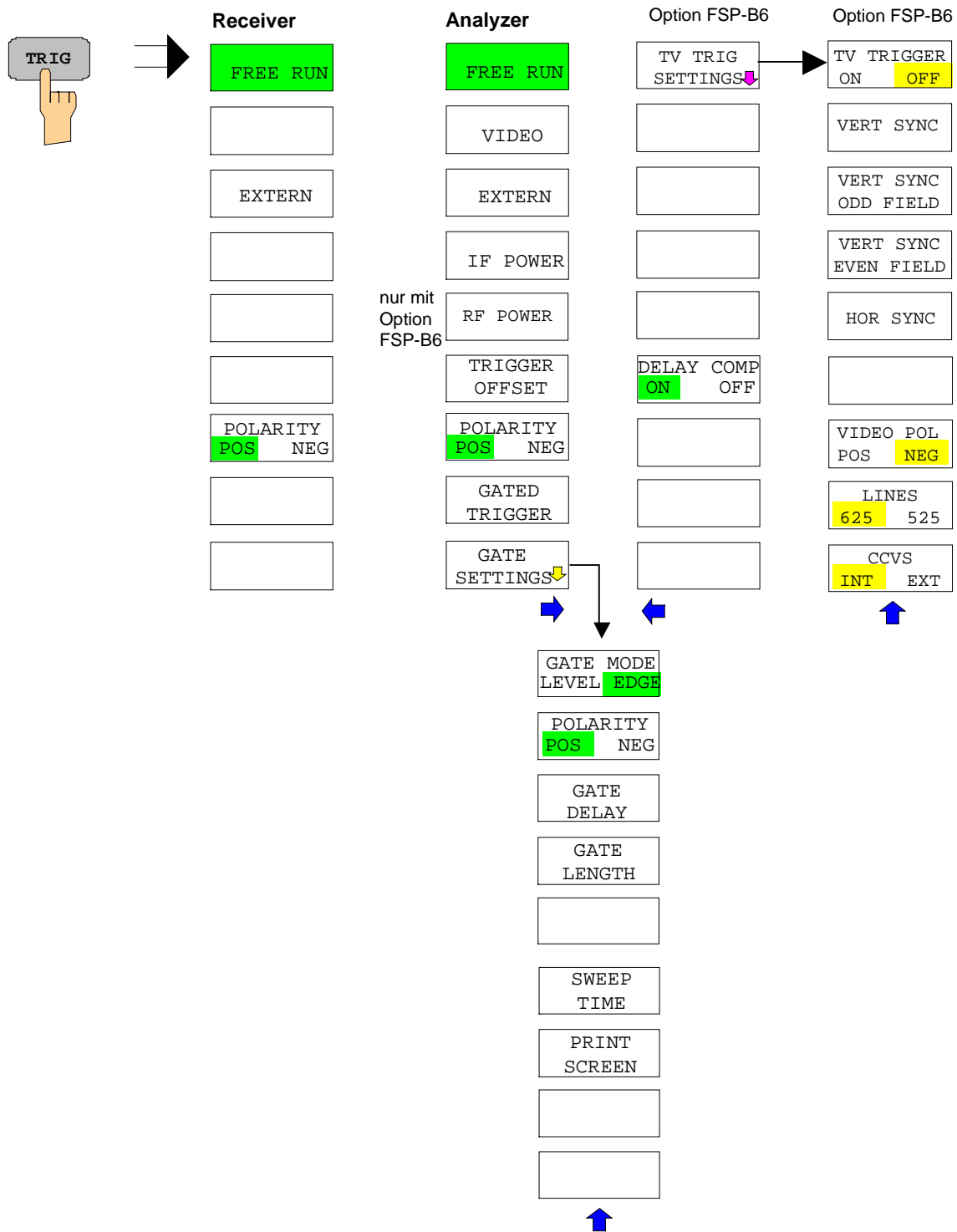

TRACE Key

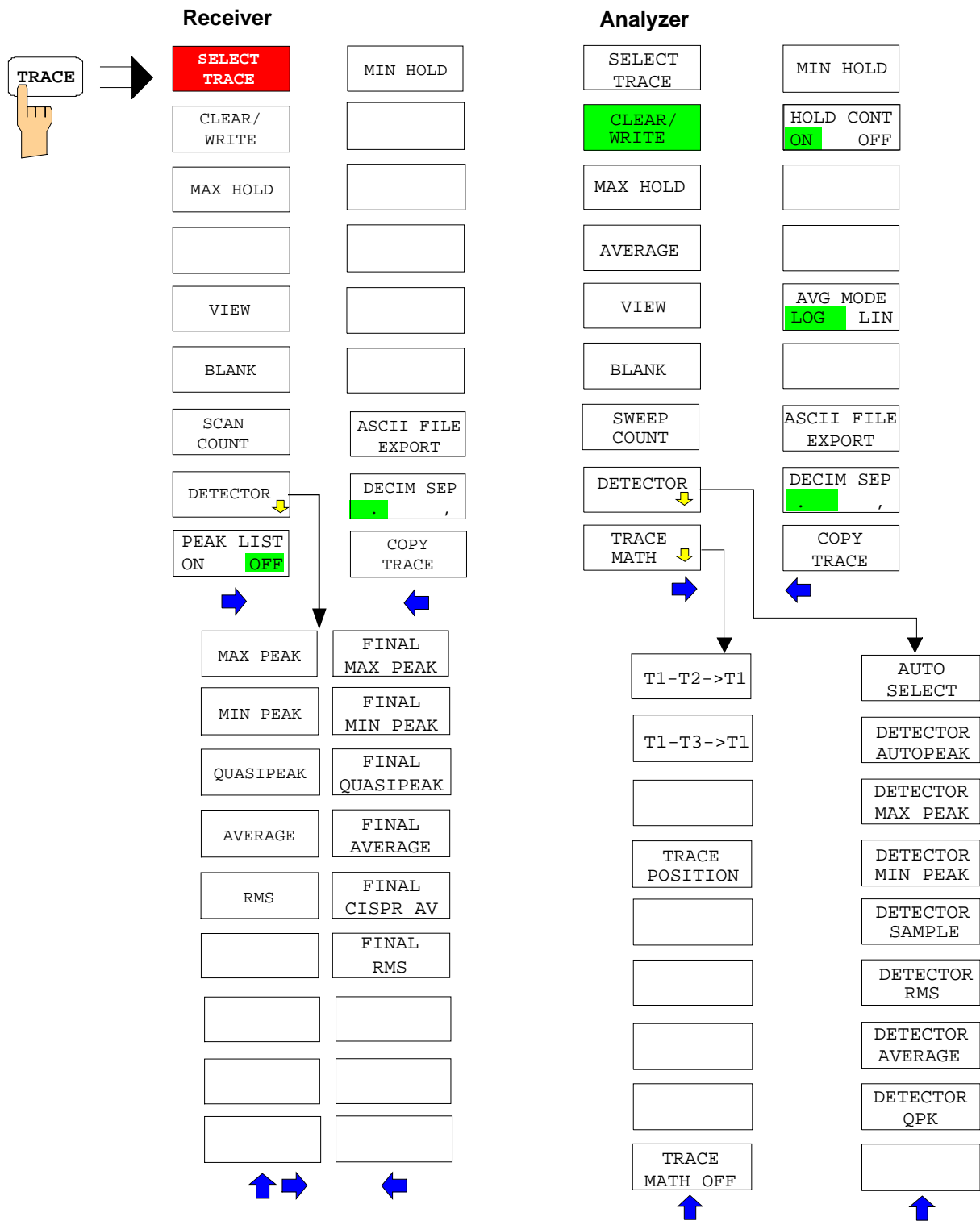

LINES Key

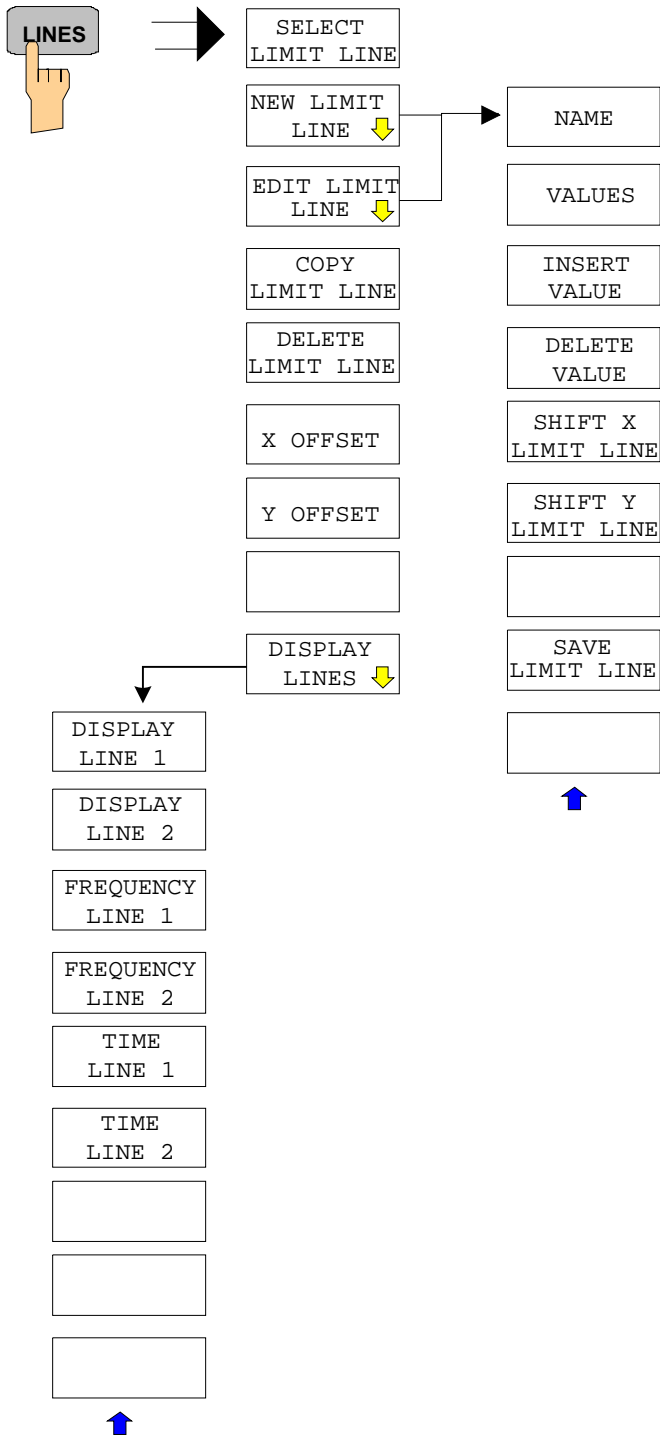

DISP Key

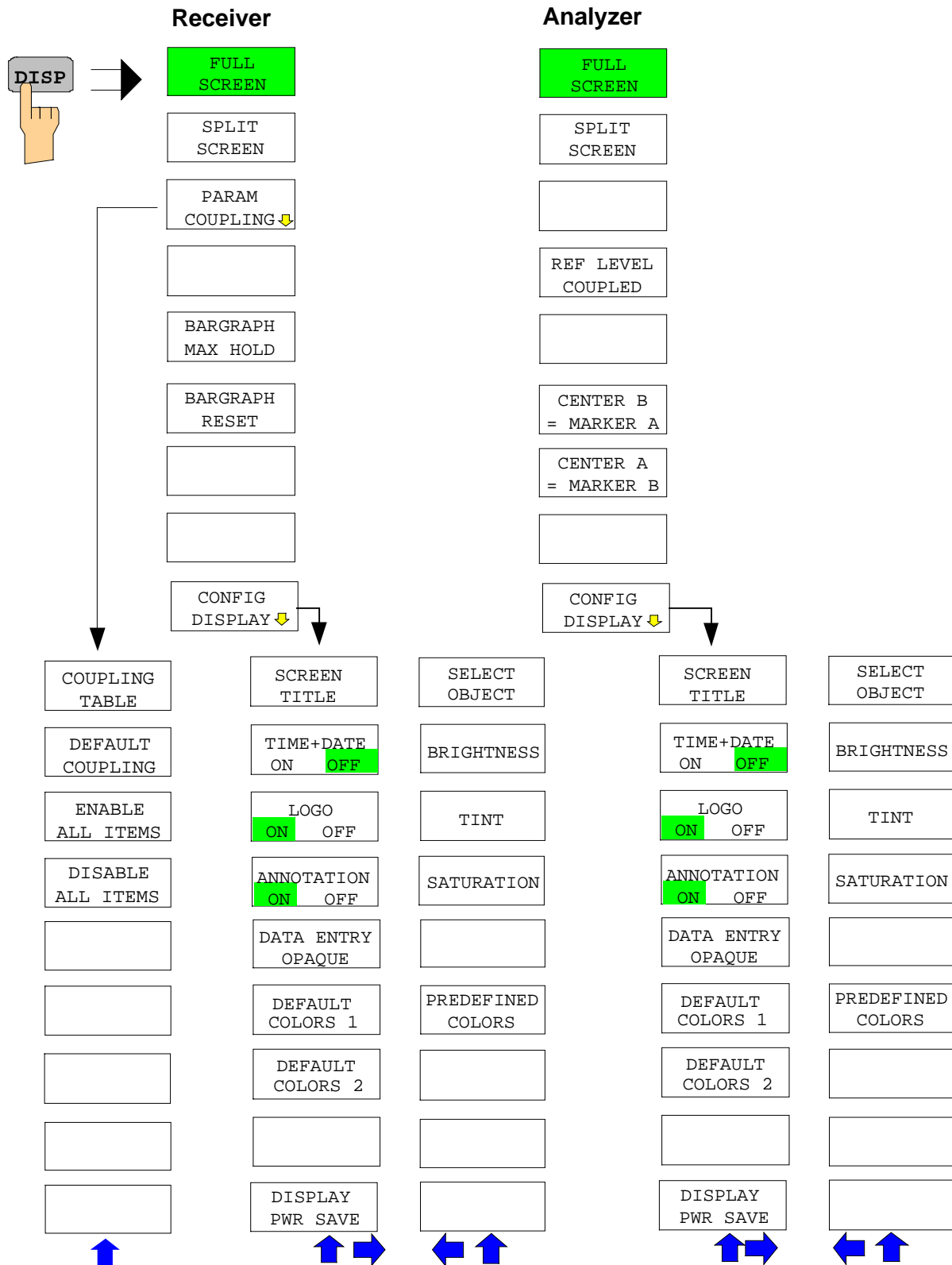

FILE Key

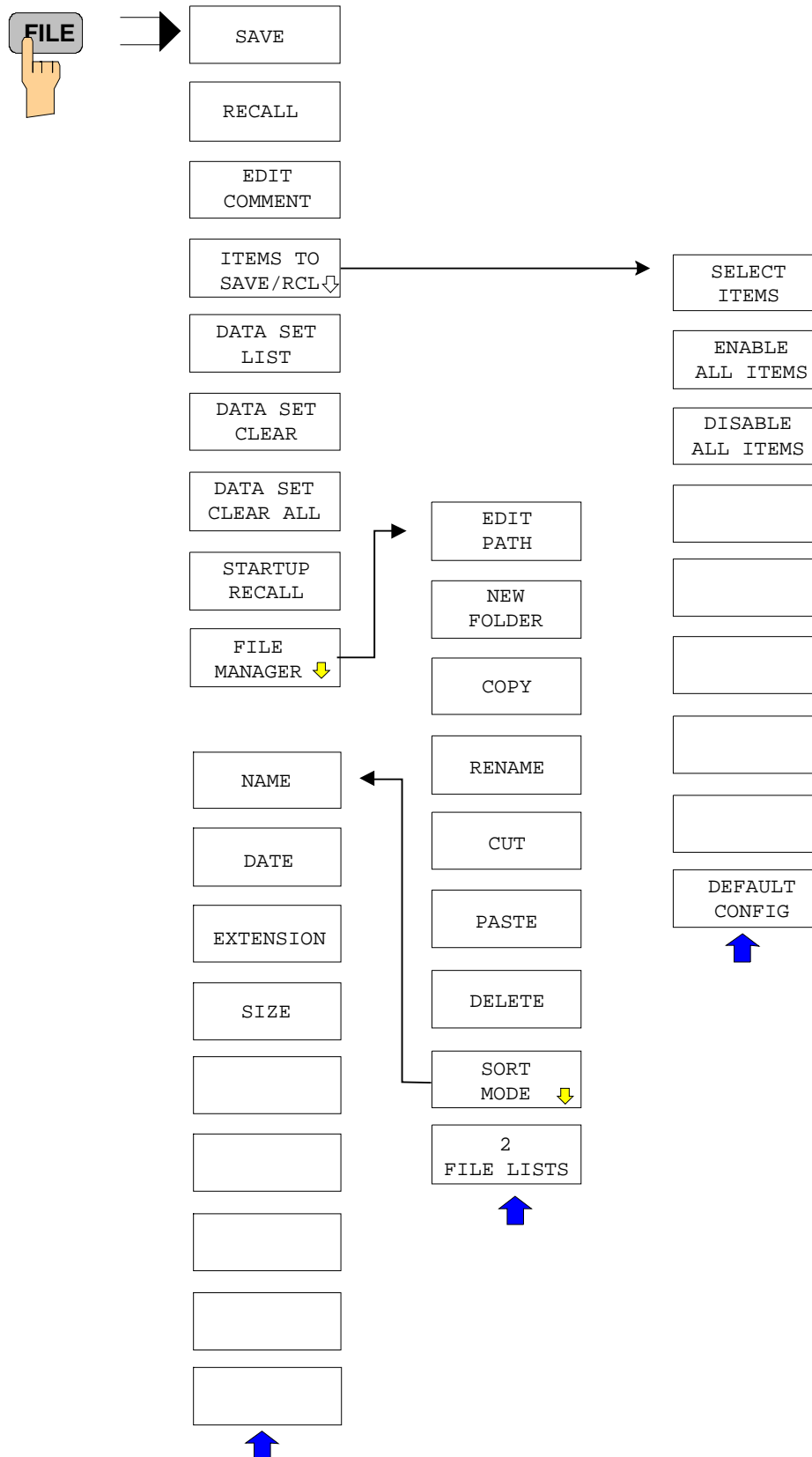

CAL Key

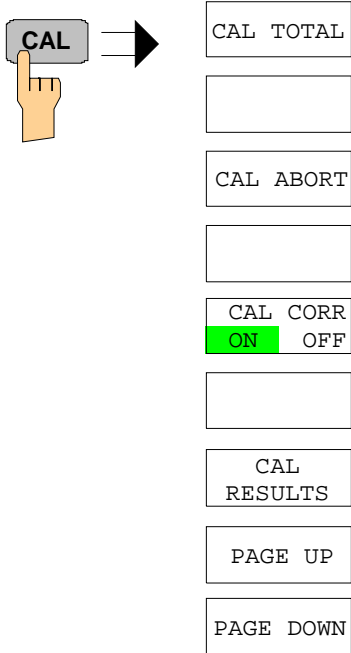

SETUP Key

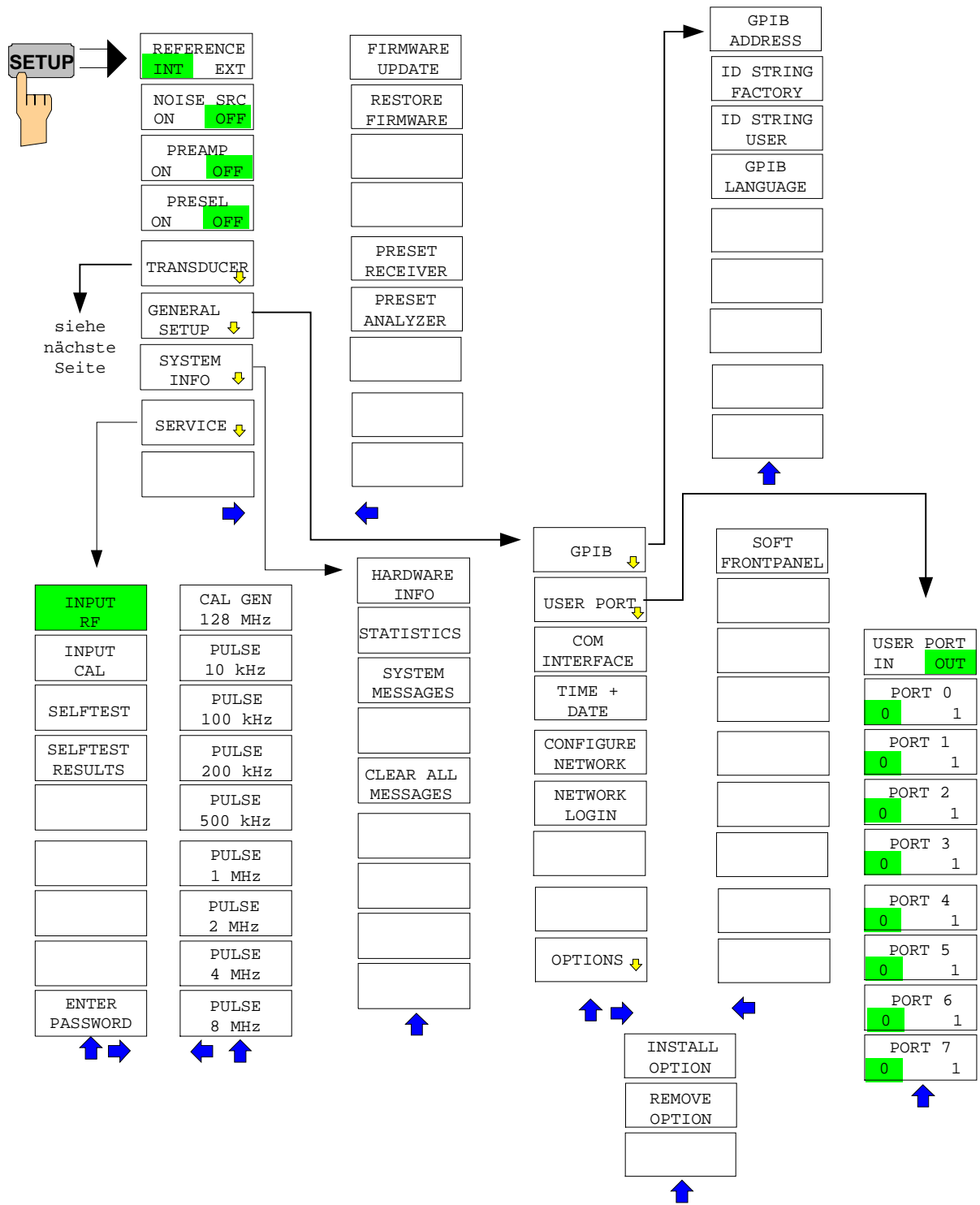

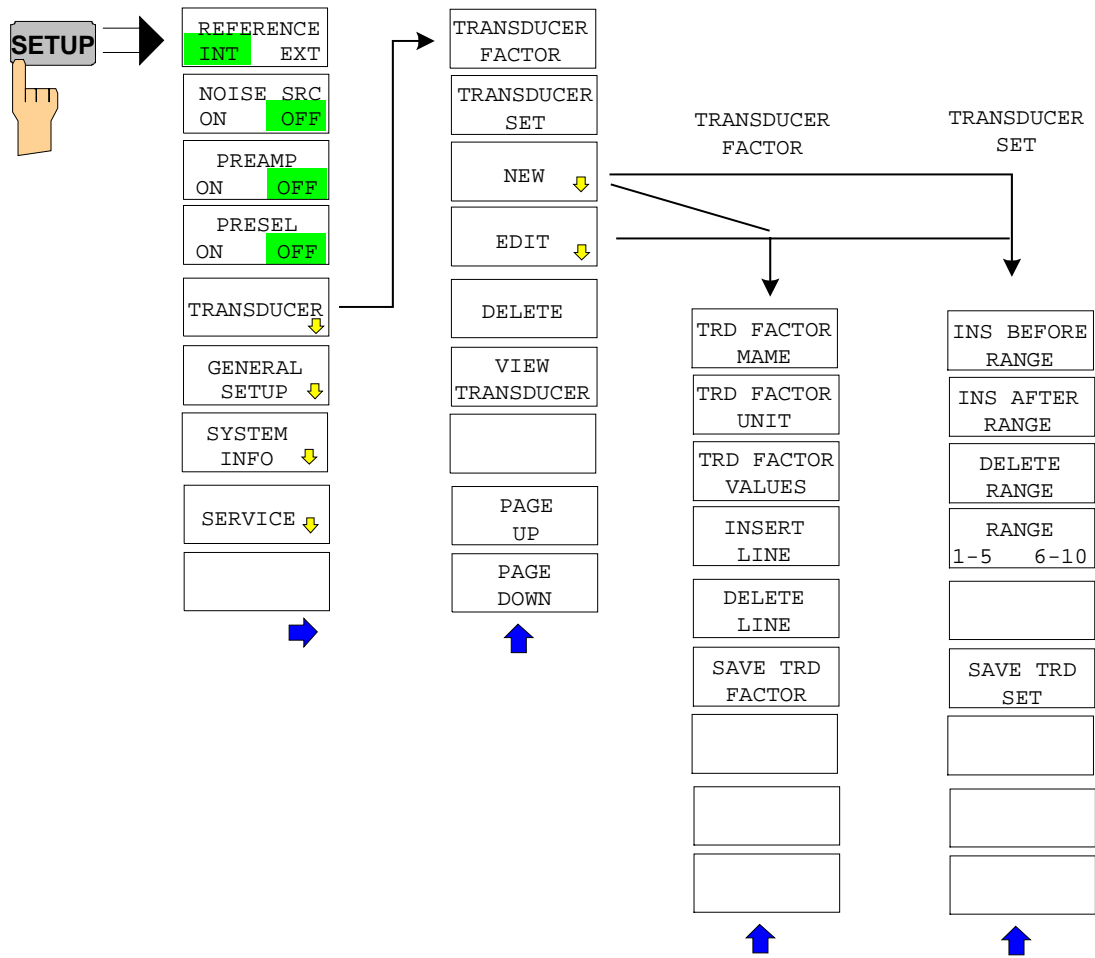

HCOPY Key

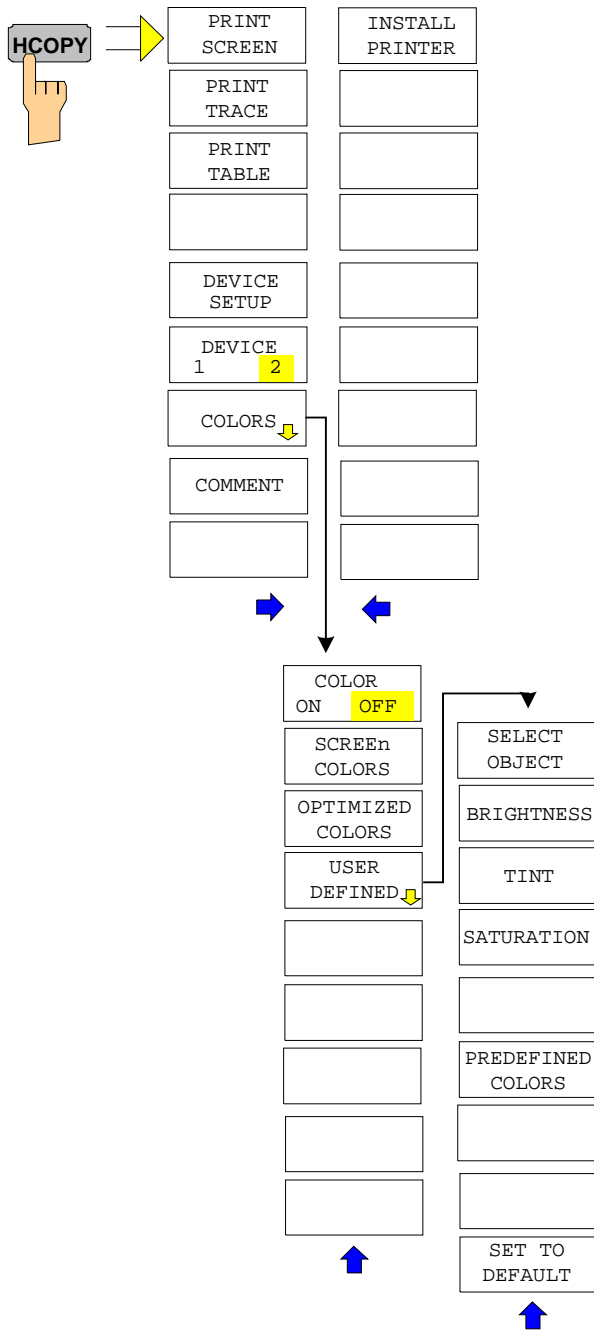

Hotkey Menu

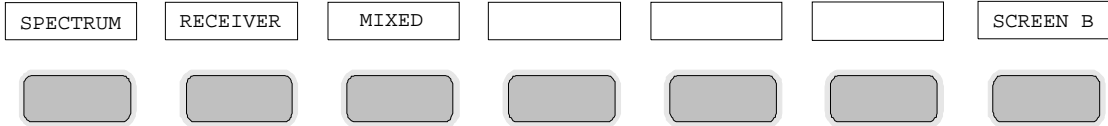

LOCAL Menu

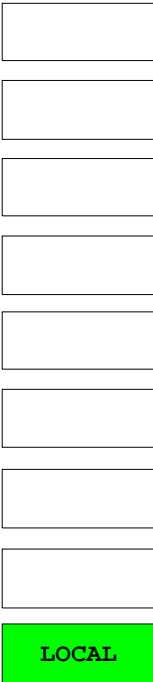

Menu Overview RECEIVER Hotkey

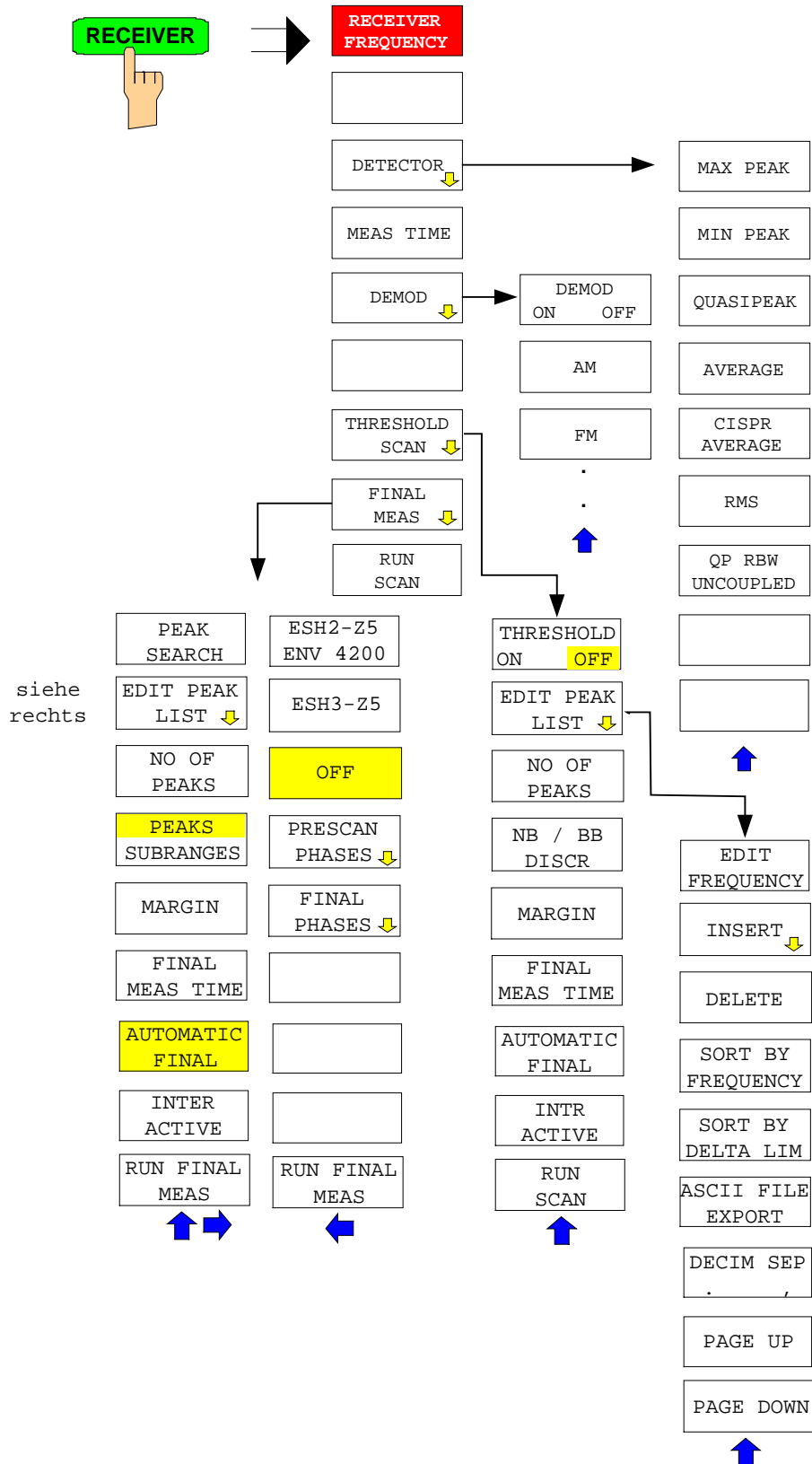

Menu Overview Option Ext. Generator Control

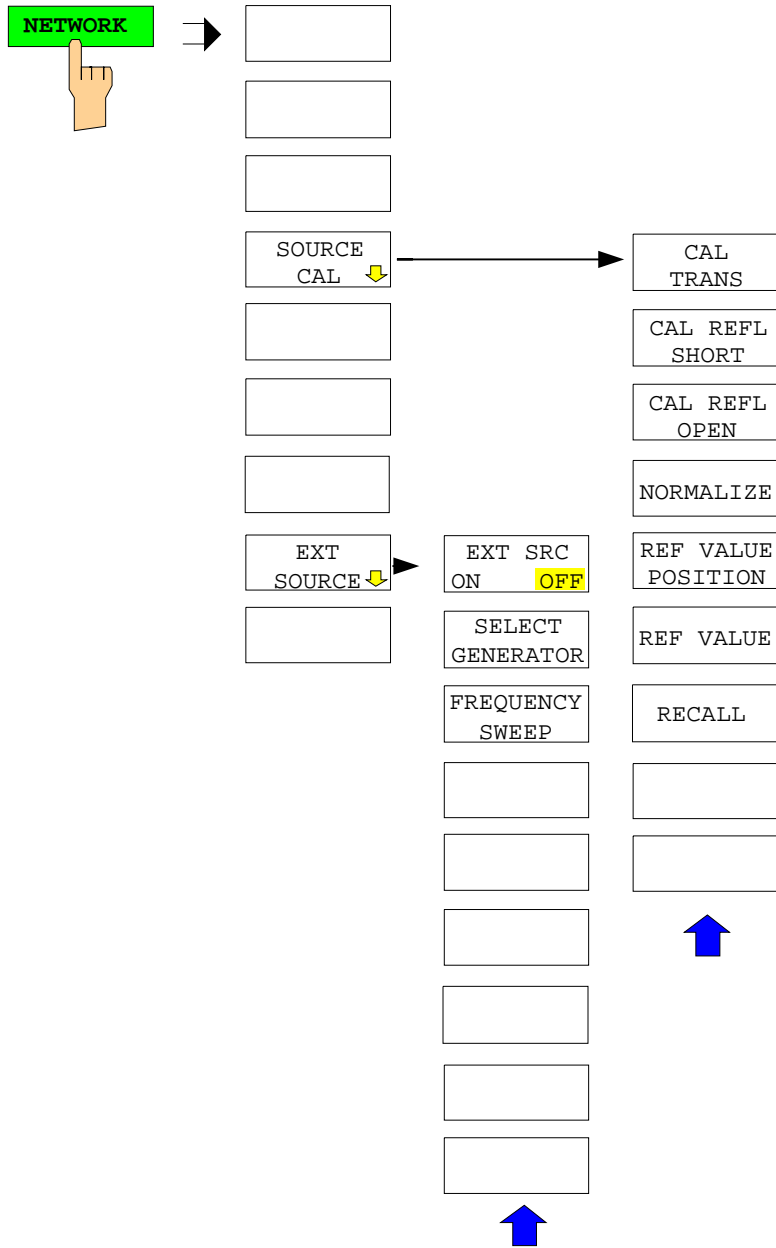

Menu Overview Option Mixed

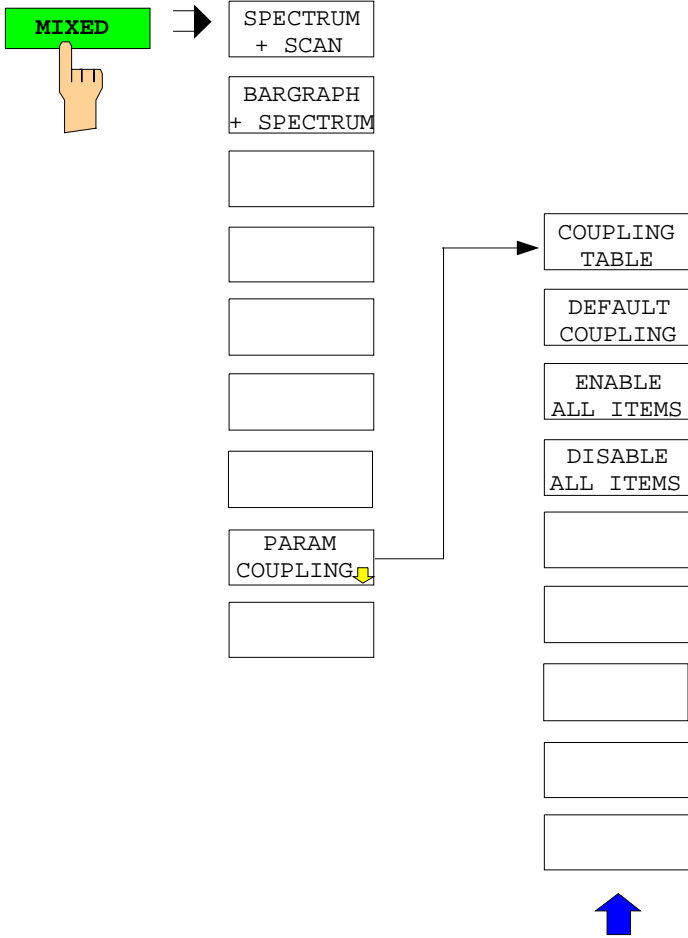

Contents - Chapter 4 "Instrument Functions"

4	Instrument Functions	4.1
	Mode Selection – <i>HOTKEY</i> Bar	4.1
	Return to manual control – <i>LOCAL</i> Menu	4.3
	R&S ESCI Initial Configuration – <i>PRESET</i> Key	4.4
	RECEIVER Mode	4.6
	Operation on a Discrete Frequency	4.7
	Setting the Receive Frequency and the Scan Range	4.7
	Level Display and RF Input Configuration – <i>AMPT</i> Key	4.9
	Preamplifier	4.10
	Setting the IF Bandwidth - <i>BW</i> Key	4.12
	List of Available Channel Filters	4.15
	Selection of the Measurement Function – <i>MEAS</i> Key	4.16
	Selecting the Detector	4.17
	Setting the Measurement Time	4.20
	AF Demodulators	4.22
	Data Reduction and Peak List	4.23
	Data Reduction using the Subrange Maximum	4.23
	Automatic Final Measurement with <i>THRESHOLD SCAN</i>	4.34
	Selection of Detectors for Final Measurement	4.38
	Automatic Control of Line Impedance Stabilization Networks	4.39
	Frequency Scan - <i>SWEEP</i> Key	4.43
	Scan in the Frequency Domain	4.43
	Scan in the Time Domain	4.44
	Display of Measurement Results	4.45
	Entry of Scan Data	4.46
	Running a Scan	4.52
	Triggering the Scan– <i>TRIG</i> Key	4.53
	Marker Functions – <i>MKR</i> Key	4.55
	Change of Settings via Markers – <i>MKR</i> ⇒ Key	4.56
	Marker Functions – <i>MKR FCTN</i> Key	4.61
	Selection and Setting of Traces – <i>TRACE</i> Key	4.62
	Selection of Trace Function	4.62
	Spectrum Analyzer Mode	4.69
	Frequency and Span Selection – <i>FREQ</i> Key	4.69
	Setting the Frequency Span – <i>SPAN</i> Key	4.74
	Level Display Setting and RF Input Configuration – <i>AMPT</i> Key	4.76
	Setting the Bandwidths and Sweep Time – <i>BW</i> Key	4.80
	List of available channel filters	4.88
	Sweep Settings – <i>SWEEP</i> Key	4.90
	Triggering the Sweep – <i>TRIG</i> Key	4.93

Option R&S FSP-B6 – TV and RF Trigger.....	4.100
Selection and Setting of Traces – TRACE Key	4.103
Selection of Trace Function	4.103
Selection of Detector.....	4.111
Mathematical Functions for Traces.....	4.116
Recording the Correction Data of R&S ESCI – CAL Key	4.117
Markers and Delta Markers – MKR Key	4.119
Frequency Measurement with the Frequency Counter.....	4.122
Marker Functions – MKR FCTN Key	4.127
Activating the Markers	4.128
Measurement of Noise Density.....	4.128
Phase Noise Measurement	4.130
Measurement of the Filter or Signal Bandwidth.....	4.132
Measurement of a Peak List.....	4.133
AF Demodulation	4.135
Selecting the Trace.....	4.136
Change of Settings via Markers – MKR ⇒ Key	4.137
Power Measurements – Hardkey MEAS.....	4.145
Power Measurement in Time Domain.....	4.146
Channel and Adjacent-Channel Power Measurements	4.151
Setting the Channel Configuration	4.158
Measurement of Signal Amplitude Statistics.....	4.170
Measurement of Carrier/Noise Ratio C/N and C/N ₀	4.176
Measurement of the AM Modulation Depth	4.178
Measurement of the Third Order Intercept (TOI).....	4.179
Setup of Limit Lines and Display Lines – LINES Key	4.182
Selection of Limit Lines	4.183
Entry and Editing of Limit Lines	4.187
Display Lines.....	4.193
Configuration of Screen Display – DISP Key.....	4.195
Instrument Setup and Interface Configuration – SETUP Key	4.203
External Reference Oscillator	4.205
External Noise Source	4.205
Preamplification and Preselection.....	4.206
Preselection	4.206
Preamplification.....	4.207
Using Transducers.....	4.208
Activating Transducer Factors and Transducer Sets.....	4.209
New Entry and Editing of Transducer Factors	4.212
New Entry and Editing of Transducer Sets	4.216
Programming the Interface Configuration and Time Setup	4.220
Selecting the IEC/IEEE-bus address	4.220
User Port Configuration	4.222
Serial Interface Configuration.....	4.223

Setting Date and Time	4.226
Configuration of network settings (with option FSP-B16 only)	4.227
Enabling Firmware Options	4.229
Emulation of the instrument front panel	4.230
System Information	4.231
Display of Module Data	4.231
Display of Device Statistics	4.232
Display of System Messages	4.233
Service Menu	4.234
General Service Functions	4.235
Selftest	4.236
Hardware Adjustment	4.237
Firmware Update	4.237
Saving and Recalling Data Sets – FILE Key	4.238
Overview	4.238
Storing a Device Configuration	4.239
Storing a Complete Device Configuration	4.239
Storing Parts of a Device Configuration	4.239
Loading a Data Set	4.240
Automatic Loading of a Data Set during Booting	4.241
Copying Data Sets to Disk	4.241
Entering Text with the Help Line Editor	4.242
Description of the Individual Softkeys	4.243
Operating Concept of File Managers	4.250
Measurement Documentation – HCOPY Key	4.255
HCOPY menu	4.255
Selecting Printer, Clipboard and File Formats	4.258
File formats	4.258
Clipboard	4.258
Printer	4.259
Selecting Alternative Printer Configurations	4.260
Selecting Printer Colours	4.260
Entering a Text with the Auxiliary Line Editor	4.263
Installation of Plug&Play Printers	4.264
Installation of Non-Plug&Play Printers	4.264
Local Printer	4.265
Network Printer	4.269
Tracking Generator - Option R&S FSP-B9	4.272
Tracking Generator Settings	4.273
Transmission Measurement	4.275
Calibration of Transmission Measurement	4.275
Normalization	4.277
Reflection Measurement	4.281
Calibration of Reflection Measurement	4.281
Calibration mechanism	4.282
Frequency-Converting Measurements	4.283

External Modulation of the Tracking Generator	4.284
Option External Generator Control - R&S FSP-B10	4.287
External Generator Settings	4.288
Transmission Measurement	4.290
Calibration of Transmission Measurement	4.290
Normalization:	4.292
Reflection Measurement	4.296
Calibration of Reflection Measurement	4.296
Calibration mechanism	4.297
Frequency-converting Measurements	4.298
Configuration of an External Generator	4.299
List of Generator Types Supported by the R&S ESCI	4.302
Option LAN Interface.....	4.305
Connecting the Instrument to the Network	4.305
Installing the Software.....	4.305
Installation of Drivers for the Network Card	4.305
Configuration of Available Network Protocols (TCP/IP Protocol).....	4.307
Installation of Further Network Protocols and Services	4.310
Examples of Configurations	4.312
Subsequent Changing of the Network Configuration	4.312
Operating the Instrument without a Network.....	4.314
Operating the Instrument on the Network.....	4.315
NOVELL Networks	4.315
MICROSOFT Network	4.315
Defining Users.....	4.316
Changing the User Password	4.318
Login in the Network	4.321
Disabling the Autologin Mechanism	4.321
Reenabling the Autologin Mechanism.....	4.321
Using Network Drives.....	4.321
Printing on a Network Printer	4.323
Remote Monitoring of R&S ESCI via XP Remote Desktop	4.328
Introduction	4.328
Configuration of R&S ESCI for Using Remote Desktop	4.328
Configuration of Controller	4.330
Setting up the Connection with the R&S ESCI.....	4.333
Interruption and Re-setup of Remote Desktop Connection with the R&S ESCI.....	4.334
Switching off the R&S ESCI from the Controller	4.335
Remote Data Transfer with TCP/IP Services.....	4.335
RSIB Protocol	4.337
Remote Control via RSIB Protocol.....	4.337
Windows Environment	4.337
UNIX Environment	4.338
RSIB Interface Functions.....	4.339
Overview of Interface Functions	4.339
Variables ibsta, iberr, ibcntl	4.340

Description of Interface Functions4.341

Programming via the RSIB Protocol4.347

 Visual Basic.....4.347

 Visual Basic for Applications (Winword and Excel).....4.350

 C / C++4.351

4 Instrument Functions

All functions of the EMI test receiver and their application are explained in detail in this chapter. The sequence of the described menu groups depends on the procedure selected for the configuration and start of a measurement:

1. Resetting the instrument - *PRESET* key
2. Setting the mode – hotkey bar and *LOCAL* key
3. Setting the measurement parameters - keys *FREQ*, *SPAN*, *AMPT*, *BW*, *SWEEP*, *TRIG*, *TRACE*, *CAL*
4. Selecting and configuring the measurement function - keys *MKR*, *MKR->*, *MKR FCTN*, *MEAS*, *LINES*

The instrument functions for general settings, printout and data management are described at the end of this chapter – keys *LINES*, *DISP*, *SETUP*, *FILE* and *HCOPY*.

The different softkeys of a menu are described from top to bottom and from the left to the right side menu. The submenus are marked by an indentation or displayed in a separate section. The whole path (key - softkey - ...) is indicated in the line above the menu display.

An overview of the menus is given in chapter 3 which also contains the description of the operating concept.

The IEC/IEEE-bus commands (if any) are indicated for each softkey. For a fast overview a list of softkeys with the associated IEC/IEEE-bus commands is given at the end of Chapter 6.

An index at the end of the handbook serves as further help for the user.

Mode Selection – *HOTKEY* Bar

For fast mode selection R&S ESCI has seven keys (the so-called *HOTKEYS*) which can be allocated depending on the options installed on the instrument.

Four keys are reserved for the basic model:

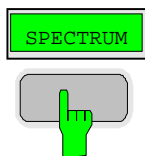
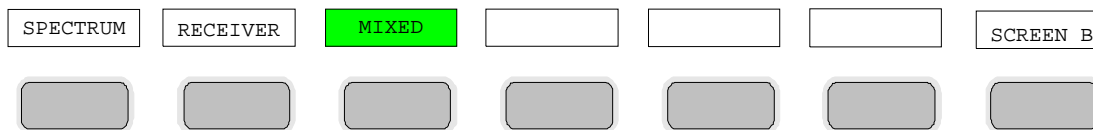

The *SPECTRUM* hotkey sets R&S ESCI to spectrum analysis mode. The spectrum analysis mode is the basic setting of R&S ESCI.

IEC/IEEE-bus command: `INST:SEL SAN`



The *RECEIVER* hotkey sets the R&S ESCI in the test receiver mode.

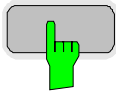

IEC/IEEE-bus command: INST:SEL REC



The *MIXED* hotkey sets the R&S ESCI in a combination of test receiver and analyzer mode. The display is set to split screen.

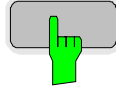

IEC/IEEE-bus command: INST:CONF:MIX ON
 INST:CONF1 REC

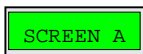

With the *SCREEN A / SCREEN B* hotkey two different settings can be selected on the R&S ESCI in the FULL SCREEN mode.

In the SPLIT SCREEN mode the key switches between active diagram A and B.

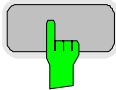

The key designation indicates the diagram which has been activated by means of the key.

The currently active window is marked by **A** or **B** on the right of the diagram.

IEC/IEEE-bus command: DISP:WIND<1 | 2>:SEL A

The meaning of the other keys is described in the chapter describing the various options.

Return to manual control – LOCAL Menu

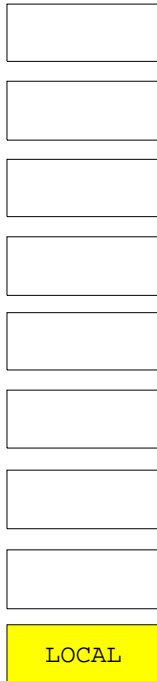

The menu LOCAL is displayed on switching the instrument to remote control mode.

At the same time, the *HOTKEY* bar is blanked out and all keys are disabled except the *PRESET* key. The diagram, traces and display fields are then blanked out (they can be activated using the remote control command `SYSTEM:DISPlay:UPDate ON`).

The menu contains only one softkey, the *LOCAL* key. The *LOCAL* key switches the instrument from remote to manual control, with the assumption that the remote controller has not previously set the *LOCAL LOCKOUT* function.

A change in the control mode consists of:

- **Enabling the Front Panel Keys**

Returning to manual mode enables all inactive keys and turns on the hotkey menu. The soft key menu which is displayed is the main menu of the current mode.

- **Inserting the measurement diagrams**

The blanked diagrams, traces and display fields are inserted.

- **Generating the message OPERATION COMPLETE**

If, at the time of pressing the *LOCAL* softkey, the synchronisation mechanism via `*OPC`, `*OPC?` or `*WAI` is active, the currently running measurement procedure is aborted and synchronisation is achieved by setting the corresponding bits in the registers of the status reporting system.

- **Setting Bit 6 (User Request) of the Event Status Register**

With a corresponding configuration of the status reporting system, this bit immediately causes the generation of a service request (*SRQ*) which is used to inform the control software that the user wishes to return to front-panel control. This information can be used, e.g., to interrupt the control program so that the user can make necessary manual corrections to instrument settings. This bit is set each time the *LOCAL* softkey is pressed.

Note: *If the LOCAL LOCKOUT function is active in the remote control mode, the front-panel PRESET key is also disabled. The LOCAL LOCKOUT state is left as soon as the process controller deactivates the REN line or the IEC/IEEE-bus cable is disconnected from the instrument.*

R&S ESCI Initial Configuration – *PRESET* Key

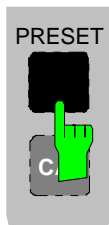

Using the *PRESET* key, the R&S ESCI can be set to a predefined initial state. Two predefined initial states can be selected in the *SETUP* side menu. Default state is *RECEIVER PRESET*. The *ANALYZER PRESET* is compatible with the settings of Test Receiver R&S ESCI and Spectrum Analyzer R&S FSP. It facilitates programming of control software for several instrument types.

Notes: *The settings are selected in a way that the RF input is always protected against overload, provided that the applied signal levels are in the allowed range for the instrument.*

*The initial instrument state set by the *PRESET* key can be adapted to arbitrary applications using the *STARTUP RECALL* function. With this function the *STARTUP RECALL* dataset is loaded upon pressing the *PRESET* key. For further information refer to section "Saving and Recalling Data Sets".*

Pressing the *PRESET* key causes the R&S ESCI to enter its initial state according to one of the following tables:

Table 4-1 RECEIVER SETUP of R&S ESCI

Parameter	Settings
Mode	Mixed (Bargraph in screen A und Spectrum in screen B)
Center frequency step size	AUTO COARSE
RF attenuation	auto (10 dB)
Reference level	87 dB μ V (-20 dBm)
Level range	100 dB log
Level unit	dB μ V
Sweep time	auto
Resolution bandwidth	Bargraph 120 kHz / 6 dB, Analyzer auto (100 kHz / 3 dB)
Video bandwidth	Bargraphj 1 MHz, Analyzer auto (300 kHz)
FFT filters	off
Span / RBW	50
RBW / VBW	Analyzer 0.33
Sweep	cont
Trigger	free run
Trace 1	clr write
Trace 2/3	Bargraph Average, Analyzer auto peak
Detector	auto peak
Trace math	off
Frequency offset	0 Hz
Reference level offset	0 dB
Reference level position	100 %
Grid	abs
Cal correction	on
Noise source	off
Input	RF
Display	Full screen, active screen A
Tracking generator (only with option R&S FSP-B9)	off
External generator 1/2 (only with option R&S FSP-B10)	off
Preamplifier	off
Preselector	off

Table 4-2 ANALYZER SETUP of R&S ESCI

Parameter	Settings
Mode	Spectrum
Center frequency step size	0.1 * center frequency
RF attenuation	auto (10 dB)
Reference level	-20 dBm
Level range	100 dB log
Level unit	dBm
Sweep time	auto
Resolution bandwidth	auto (3 MHz)
Video bandwidth	auto (10 MHz)
FFT filters	off
Span / RBW	50
RBW / VBW	0.33
Sweep	cont
Trigger	free run
Trace 1	clr write
Trace 2/3	blank
Detector	auto peak
Trace math	off
Frequency offset	0 Hz
Reference level offset	0 dB
Reference level position	100 %
Grid	abs
Cal correction	on
Noise source	off
Input	RF
Display	Full screen, active screen A
Tracking generator (only with option R&S FSP-B9)	off
External generator 1/2 (only with option R&S FSP-B10)	off
Preamplifier	off
Preselector	off

RECEIVER Mode

The mode is selected using the *RECEIVER* hotkey (see also section "Mode Selection")

The mode is selected with the *RECEIVER* hotkey for displaying both subscreens or with the *MIXED* hotkey for displaying one subscreen as the receiver. The *RECEIVER* variant is described here. The description applies correspondingly to *MIXED* (see also section "Mode Selection – *HOTKEY* Bar").

RECEIVER menu:

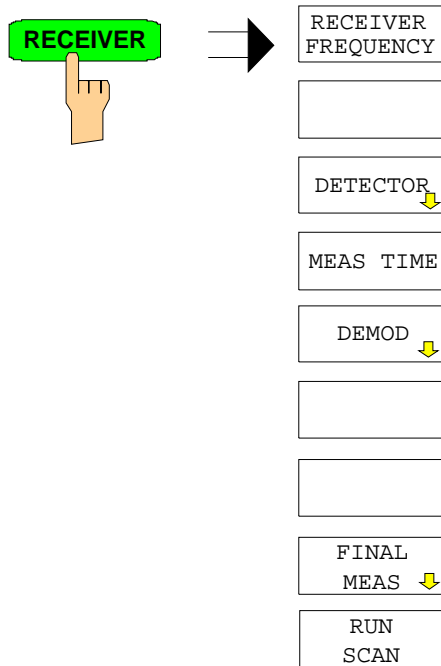

The *RECEIVER* hotkey selects the receiver mode (RFI reception) and activates the menu for setting the receiver parameters.

For description of the softkeys see the following menus:

<i>RECEIVER FREQUENCY</i>	<i>FREQ</i> menu, page 4.7
<i>DETECTOR</i>	<i>MEAS</i> menu, page 4.17
<i>MEAS TIME</i>	<i>MEAS</i> menu, page 4.20
<i>DEMOD</i>	<i>MEAS</i> menu, page 4.22
<i>THRESHOLD SCAN</i>	<i>MEAS</i> menu, page 4.34
<i>FINAL MEAS</i>	<i>MEAS</i> menu, page 4.23
<i>RUN SCAN</i>	<i>SWEEP</i> menu, page 4.52

IEC/IEEE-bus command :INST REC

In the receiver mode, R&S ESCI acts as a test receiver, i.e. it measures the level at the set frequency with a selected bandwidth and measurement time (*RES BW* and *MEAS TIME* softkeys). Signal weighting is by means of the average, max peak, min peak, RMS and quasi-peak detectors (*DETECTOR* softkey).

The functions for data reduction and the control of line impedance simulating network are available in the *FINAL MEAS* sub menu.

A frequency scan can be performed after setting the start and stop frequency and the step width. The scan subranges can be defined in a table (*DEFINE SCAN* softkey).

The scan is started with the *RUN SCAN* softkey. In operating mode *RECEIVER*, the *RECEIVER* hotkey directly opens the *RECEIVER* menu.

The R&S ESCI is fitted with a preselection with switchable preselection. Preselection is always switched on in receiver mode.

Operation on a Discrete Frequency

Setting the Receive Frequency and the Scan Range

The *FREQ* key opens the *FREQUENCY* menu for setting the receive frequency in manual mode and the frequency axis for scan display.

FREQ menu

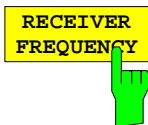
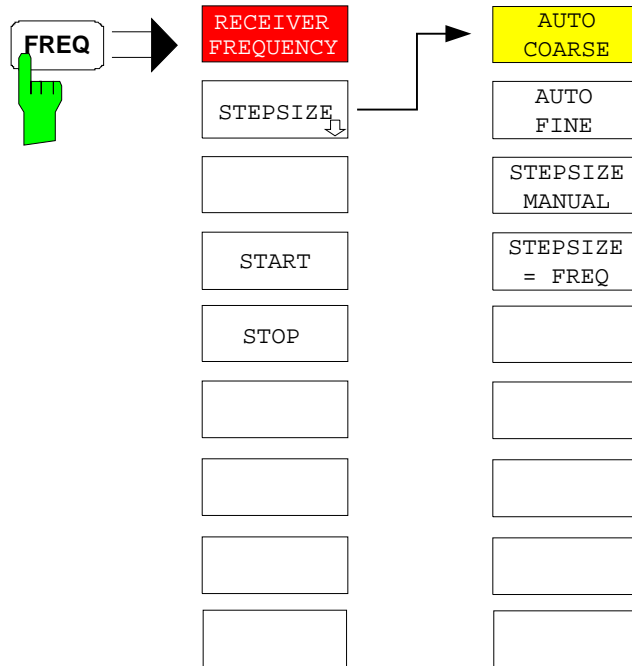

The *RECEIVER FREQUENCY* softkey activates the entry field of the receive frequency.

The tuning frequency has to be set to at least twice the IF bandwidth.

When the tuning frequency is lower than twice the IF bandwidth, the IF bandwidth is automatically reduced so that this condition is met again.

If the frequency is increased again, the original IF bandwidth is restored (memory function). The memory is cleared when the IF bandwidth is manually changed.

The resolution of the receive frequency is always 0.1 Hz.

Range: $9 \text{ kHz} \leq f_{\text{rec}} \leq f_{\text{max}}$

Note: This softkey is also available in the *RECEIVER* menu.

IEC/IEEE-bus command :FREQ:CENT 300 MHz

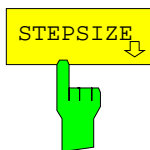

The *STEPSIZE* opens a sub menu for setting the step size of the receive frequency. The step size can be coupled to the set frequency or be manually set to a fixed value. The softkeys of the submenu are mutually exclusive selection switches. Only one switch can be activated at any one time.

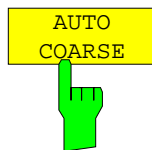

If the *AUTO COARSE* softkey is activated, the receive frequency is set in coarse steps. The 4th digit of the selected frequency is varied.

IEC/IEEE-bus command --

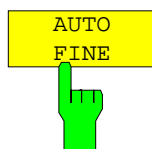

If the *AUTO FINE* softkey is activated, the receive frequency is set in fine steps. The 7th digit of the selected frequency is varied.

IEC/IEEE-bus command --



The *STEPSIZE MANUAL* softkey activates the entry window for the input of a fixed step size.

IEC/IEEE-bus command `FREQ:CENT:STEP 50 kHz`



The *STEPSIZE = FREQ* softkey sets the step size to a value equal to the receive frequency.

This function is especially useful during measurements of the signal harmonic content, because, when entering the receiver frequency, the receiver frequency of another harmonic is selected with each stroke of the *STEP* key.

IEC/IEEE-bus command --

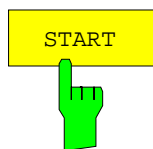

The *START* softkey opens a window where the start frequency of the scan diagram can be entered.

The permissible value range for the start frequency is:

$$f_{\min} \leq f_{\text{start}} \leq f_{\max} - 10 \text{ Hz}$$

f_{start} start frequency
 f_{\max} maximum frequency

IEC/IEEE bus command `:FREQ:STAR 20 MHz`

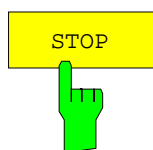

The *STOP* softkey opens a window where the stop frequency of the scan diagram can be entered.

The permissible value range for the stop frequency is:

$$f_{\min} + 10 \text{ Hz} \leq f_{\text{stop}} \leq f_{\max}$$

f_{stop} stop frequency
 f_{\max} maximum frequency

IEC/IEEE bus command `:FREQ:STOP 2000 MHz`

Level Display and RF Input Configuration – AMPT Key

The *AMPT* key is used to set the input attenuation, the preamplifier, the auto range function and the display unit.

In addition, the level display range for the scan can be set.

AMPT menu:

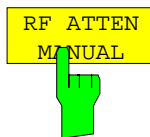
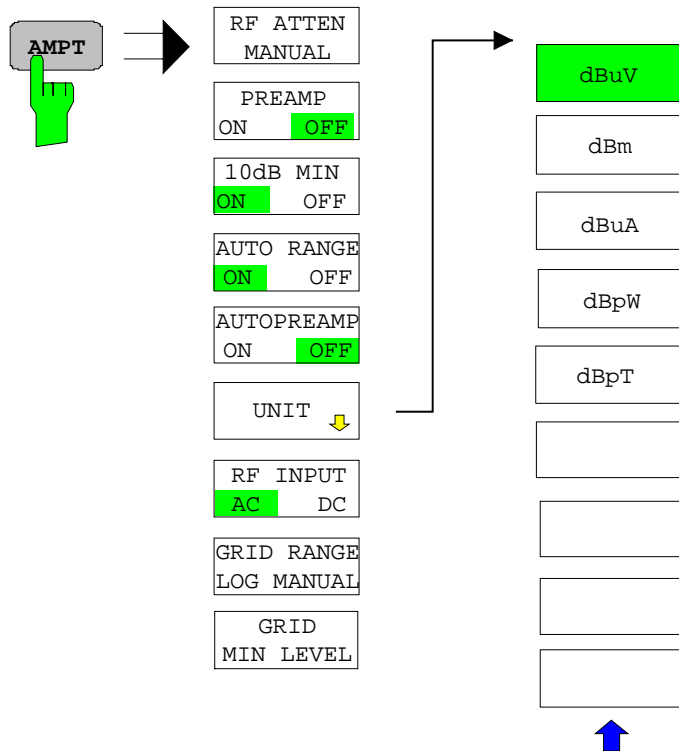

The *RF ATTEN MANUAL* softkey activates the attenuation entry field.

The attenuation can be set between 0 and 70 dB in 10 dB steps. Other entries are rounded to the next higher integer.

Note: To protect the input mixer against inadvertent overload, 0 dB can only be switched on when function 10 dB MIN is switched off.

IEC/IEEE-bus command INP:ATT 40 DB

Preamplifier

equipped R&S ESCI is provided with a switchable preamplifier of 20 dB gain in the frequency range up to 3 GHz.

Switching on the preamplifier reduces the total noise figure of R&S ESCI and thus improves the sensitivity. The disadvantage of a poorer large-signal immunity (intermodulation) is reduced by the connected preselector. The signal level of the subsequent mixer is 20 dB higher so that the maximum input level is reduced by the gain of the preamplifier. The total noise figure of R&S ESCI is reduced from approx. 18 dB to approx. 10 dB when a preamplifier is used. The use of the preamplifier is recommended when measurements with a maximum sensitivity are to be performed. On the other hand, if the measurement should be performed at maximum dynamic range, the preamplifier should be switched off.

The gain of the preamplifier is automatically considered in the level display. The preamplifier follows the preselection filters so that the risk of overdriving by strong out-of-band signals is reduced to a minimum.

CONFIGURATION MODE - RECEIVER menu

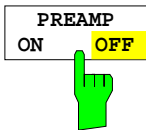

The *PREAMP ON/OFF* softkey switches the preamplifier (9 kHz to 3 GHz) on and off.

Default value is OFF.

IEC/IEEE-bus command : INP:GAIN:STAT ON | OFF

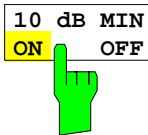

The *10 DB MIN* softkey determines whether the 10 dB setting of the attenuator may be used in the manual or automatic setting of the attenuator.

10 DB MIN ON is the default value, i.e. an RF attenuation of at least 10 dB is always set on R&S ESCI to protect the input mixer.

An attenuation of 0 dB cannot be set manually either. This avoids 0 dB being switched on inadvertently particularly when DUTs with high RFI voltage are measured.

IEC/IEEE-bus command : INP:ATT:PROT ON | OFF

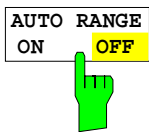

The *AUTO RANGE ON/OFF* softkey switches the autorange function on and off.

ON The attenuation is automatically set so that a good S/N ratio is obtained without the receiver stages being overdriven.

OFF The attenuation is set manually.

IEC/IEEE-bus command : INP:ATT:AUTO ON | OFF

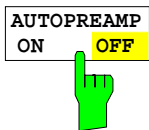

The *AUTOPREAMP ON/OFF* softkey switches the autopreamp function and or off.

ON The preamplifier is considered in the autorange procedure. The preamplifier is cut in when the RF attenuation is reduced to the minimum settable value.

OFF The preamplifier is not considered in the autorange procedure.

IEC/IEEE-bus command : INP:GAIN:AUTO ON | OFF



The *UNIT* key opens a submenu in which the desired units for the level axis can be selected.

Default setting is dB μ V.

In general, a receiver measures the signal voltage at the RF input. The level display is calibrated in rms values of an unmodulated sinewave signal. Via the known input resistance of 50 Ω a conversion can be made to other units. The units dBm, dB μ A, dBpW, and dBpT are directly convertible.

IEC/IEEE-bus command CALC:UNIT:POW DBM

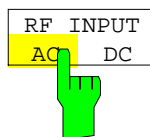

The *RF INPUT AC/DC* softkey switches between AC and DC coupling of the instrument input.

IEC/IEEE bus commands INP:COUP AC



The *GRID RANGE LOG MANUAL* softkey activates the entry of the level display range for the scan diagram. The display ranges go from 10 to 200 dB in 10-dB steps. Invalid entries are rounded off to the nearest valid value.

IEC/IEEE bus commands DISP:WIND:TRAC:Y:SPAC LOG
DISP:WIND:TRAC:Y 120DB



The *GRID MIN LEVEL* softkey activates the entry of the minimum level of the display range. Allowed values are:

- 200 \leq GRID MIN LEVEL \leq + 200 dB - GRID RANGE

IEC/IEEE bus commands DISP:WIND:TRAC:Y:SPAC LOG
DISP:WIND:TRAC:Y:BOTT 0DBM

Setting the IF Bandwidth - BW Key

R&S ESCI offers the IF bandwidths (3 dB bandwidths) from 10 Hz to 10 MHz available in steps of 1/3/10 and the IF bandwidths (6 dB bandwidths) 200 Hz, 9 kHz, 120 kHz and 1 MHz.

The resolution bandwidths up to 120 kHz are implemented by digital Gaussian bandpass filters. As far as attenuation characteristic is concerned, they behave like analog filters, but they have a much higher measurement speed than comparable analog filters. This is due to the fact that the transient response can be compensated because the filters have an accurately defined behavior.

Bandwidths of 300 kHz and higher are implemented by decoupled LC filters. These filters contain 4 filter circuits.

BW menu:

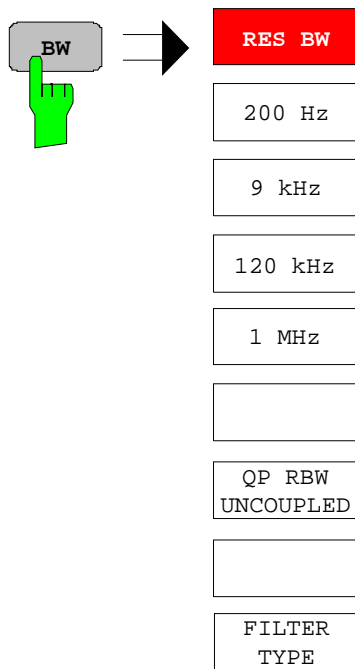

The *BW* opens the menu for setting the resolution bandwidth.

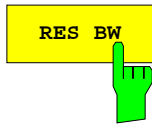

The *RES BW* softkey activates the manual entry mode for the resolution bandwidth.

For filter type NORMAL (3dB), the bandwidth can be set from 10 Hz to 10 MHz in steps of 1/3/10. For filter type NORMAL (6dB), the 6-dB bandwidth 200 Hz, 9 kHz, 120 kHz and 1 MHz can be set.

For numerical inputs, the values are always rounded to the next valid bandwidth. For rollkey or the UP/DOWN key entries, the bandwidth is adjusted in steps either upwards or downwards.

For the CHANNEL and RRC filter types, the bandwidth is selected from a list of available channel filters, which is included at the end of this section. The list can be scrolled with the \uparrow and \downarrow keys to select a filter (see section "List of Available Channel Filters").

When the quasi-peak detector is switched on, a fixed bandwidth is preset depending on the frequency. The coupling of the IF bandwidth to the frequency range with activated quasi peak detector can be cancelled using the *QP RBW UNCOUPLED* softkey (see below).

The bandwidth is limited by the set receive frequency:

$$\text{RES BW} \leq f_{\text{in}} / 2$$

IEC/IEEE-bus command BAND 1 MHz

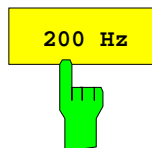

The *200 Hz* softkey sets the CISPR bandwidth 200 Hz.

IEC/IEEE-bus command BAND 200 Hz

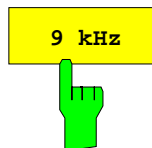

The *9 kHz* softkey sets the CISPR bandwidth 9 kHz.

IEC/IEEE-bus command BAND 9 kHz

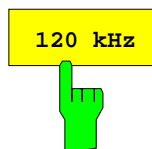

The *120 kHz* softkey sets the CISPR bandwidth 120 kHz.

IEC/IEEE-bus command BAND 120 kHz

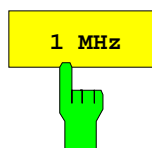

The *1 MHz* softkey sets the 6-dB bandwidth 1 MHz.

IEC/IEEE-bus command BAND 1 MHz



The *QP RBW UNCOUPLED* softkey cancels the coupling of the IF bandwidth to the frequency range with activated quasi peak detector. If the coupling is cancelled, any of the three CISPR bandwidths 200 Hz, 9 kHz, 120 kHz can be selected for a given frequency range.

IEC/IEEE-bus command BAND: AUTO ON

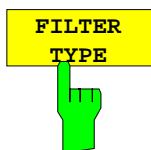

The *FILTER TYPE* softkey opens a list of available filter types. Gaussian bandpass filters of 3 dB and 6 dB bandwidth as well as channel filters are available.

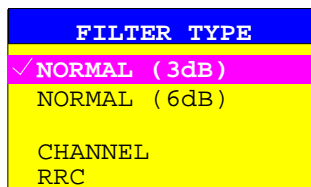

NORMAL(3dB) The resolution bandwidths are implemented by Gaussian filters with the set 3 dB bandwidth and correspond approximately to the noise bandwidth. For bandwidths up to 100 kHz, digital bandpass filters are used.

IEC/IEEE-bus command BAND:TYPE NOIS
BAND:TYPE NORM

NORMAL(6dB) The resolution bandwidths are implemented by Gaussian filters with the set 6 dB bandwidth and correspond approximately to the pulse bandwidth. For bandwidths up to 120 kHz, digital bandpass filters are used.

IEC/IEEE-bus command BAND:TYPE PULS

Moreover, several particularly steep-edged channel filters are available for power measurements.

There are two types of filter:

CHANNEL = steep-edged channel filters

IEC/IEEE-bus command: BAND:TYPE CFIL

RRC = Root Raised Cosine filters

IEC/IEEE-bus command: BAND:TYPE RRC

List of Available Channel Filters

The channel filters included in the following table are available as resolution filters (softkey *RES BW*) after activation with softkey *FILTER TYPE*. The channel filters ≥ 2.0 MHz are only available for instruments equipped with a model ≥ 3 of the IF FILTER module (see column *MODEL* in *HARDWARE INFO* table, *SETUP SYSTEM INFO* menu)

Note: For filter type *RRC* (Root Raised Cosine) the filter bandwidth indicated describes the sampling rate of the filter.
For all other filters (*CFILter*), the filter bandwidth is the 3-dB bandwidth.

Filter Bandwidth	Filter Type	Application
100 Hz 200 Hz 300 Hz 500 Hz	CFILter CFILter CFILter CFILter	A0
1 kHz 1.5 kHz 2 kHz 2.4 kHz 2.7 kHz 3 kHz 3.4 kHz 4 kHz 4.5 kHz 5 kHz 6 kHz 8.5 kHz 9 kHz	CFILter CFILter CFILter CFILter CFILter CFILter CFILter CFILter CFILter CFILter CFILter CFILter CFILter	SSB DAB, Satellite ETTS300 113 (12.5 kHz channels) AM Radio
10 kHz 12.5 kHz 14 kHz 15 kHz 16 kHz 18 kHz, $\alpha=0.35$ 20 kHz 21 kHz 24.3 kHz, $\alpha=0.35$ 25 kHz 30 kHz 50 kHz	CFILter CFILter CFILter CFILter RRC CFILter CFILter RRC CFILter CFILter CFILter	CDMAone ETTS300 113 (20 kHz channels) ETTS300 113 (25 kHz channels) TETRA PDC IS 136 CDPD, CDMAone
100 kHz 150 kHz 192 kHz 200 kHz 300 kHz 500 kHz	CFILter CFILter CFILter CFILter CFILter CFILter	FM Radio PHS J.83 (8-VSB DVB, USA)
1.0 MHz 1.2288 MHz 1.5 MHz 2.0 MHz* 3.0 MHz* 3.84 MHz, $\alpha=0.22^*$ 4.096 MHz, $\alpha=0.22^*$ 5.0 MHz*	CFILter CFILter CFILter CFILter CFILter RRC RRC CFILter	CDMAone CDMAone DAB W-CDMA 3GPP W-CDMA NTT DOCMo

*) requires IF filter model index ≥ 3

Selection of the Measurement Function – MEAS Key

The MEAS key opens the menu to select the detectors and set the measurement time for the receiver and the audio demodulator.

To reduce the amount of data in RFI voltage measurements, a list of subrange maxima (softkey *PEAK SEARCH*) can be generated from the scan results and an acceptance line (softkey *MARGIN*) may be defined in submenu *FINAL MEAS*. A final measurement is performed only for frequencies with high RFI level.

The final measurement may be either automatic (softkey *AUTOMATIC FINAL*) or in interactive mode (softkey *INTERACTIVE*). Automatic control functions for line impedance stabilization networks (softkey *LISM*) are available in the side menu. The final measurement is started with the softkey *RUN FINAL MEAS*.

The *THRESHOLD SCAN* function is also used to reduce data. The scan is immediately interrupted when a limit violation is detected and the final measurement performed within a short time.

MEAS menu:

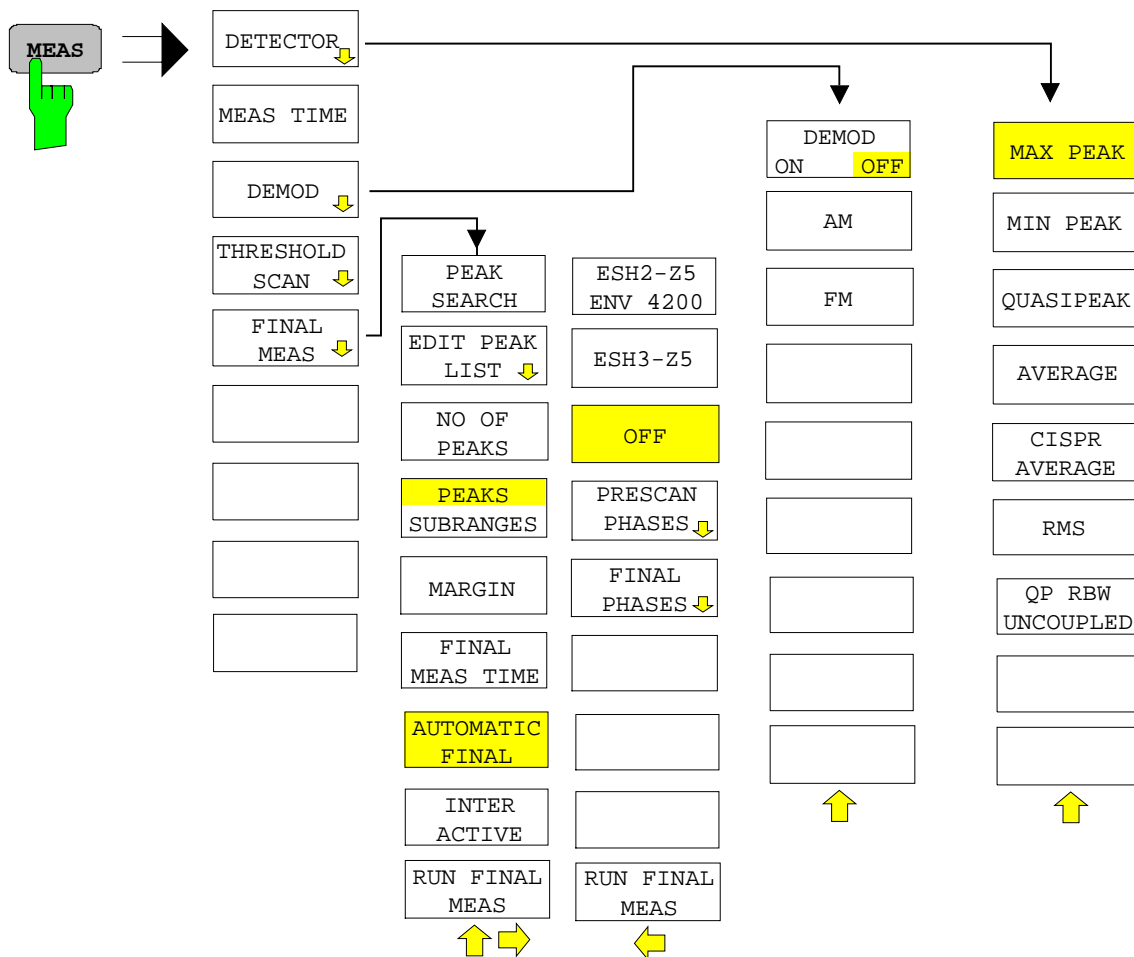

Selecting the Detector

Six different detectors can be selected for weighting the receive signal.

- The max peak detector yields the largest sample values of the levels measured during the set measurement time.
- The min peak detector yields the smallest sample values of the levels measured during the set measurement time.
- The average detector yields the average level of the samples measured during the set measurement time.
- The CISPR average detector supplies a weighted average. When measuring the average according to CISPR 16-1, the maximum value of the linear average during the measurement time is displayed. The detector is used, for example, to measure pulsed sinusoidal signals with a low pulse frequency. It is calibrated with the rms value of an unmodulated sinusoidal signal. Averaging is with lowpass filters of the 2nd order (simulation of a mechanical instrument). The lowpass time constants and the IF bandwidths are fixed depending on the frequency. The main parameters are listed in the following table:

	Band A	Band B	Band C/D
Frequency range	< 150 kHz	150 kHz to 30 MHz	> 30 MHz
IF bandwidth	200 Hz	9 kHz	120 kHz
Time constant of instrument	160 ms	160 ms	100 ms

For frequencies above 1 GHz, the R&S ESCI uses the 120 kHz bandwidth of band C/D.

Coupling of the IF bandwidth to the frequency range with the CISPR average detector activated can be switched off by the *QP RBW UNCOUPLED* softkey.

- The rms detector yields the rms level of the samples measured. The integration time corresponds to the set measurement time.
- The quasi-peak detector yields the maximum detected value weighted to CISPR 16. Depending on the set frequency, the R&S ESCI automatically selects the detectors and IF bandwidths defined for bands A, B and C/D listed in the following table:

	Band A	Band B	Band C/D
Frequency range	< 150 kHz	150 kHz to 30 MHz	> 30 MHz
IF bandwidth	200 Hz	9 kHz	120 kHz
Charge time constant	45 ms	1 ms	1 ms
Discharge time constant	150 ms	500 ms	550 ms
Time constant of instrument	160 ms	160 ms	100 ms

For frequencies above 1 GHz, the R&S ESCI uses the 120 kHz bandwidth of band C/D.

The coupling of the IF bandwidth to the frequency range with activated quasi peak detector can be cancelled using the *QP RBW UNCOUPLED* softkey.

- The input signal of R&S ESCI can be displayed weighted by three detectors simultaneously.

Multiple detection is important in EMI measurements since, for example, civil standards specify limits for both the quasi-peak and the average value. Thanks to the multiple use of detectors, only one test run is needed. The peak detector can be combined with any other detector since it is the fastest detector and therefore ideal for overview measurements.

DETECTOR menu:

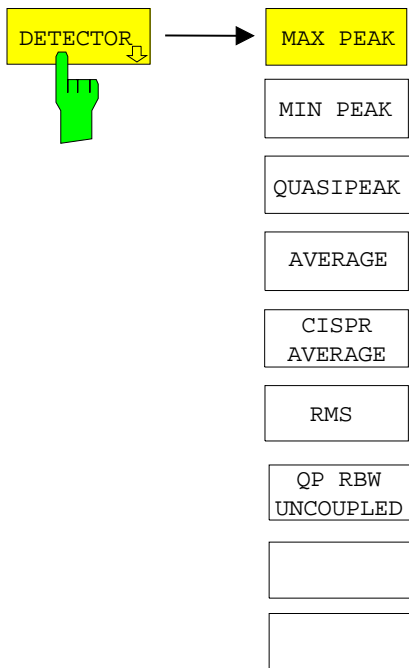

The *DETECTOR* softkey opens a submenu to select the detector and combinations of detectors.

A maximum of three detectors can be switched on simultaneously.

Note: This softkey is also available in the Receiver-menu.



The *MAX PEAK* softkey activates the max peak detector.

IEC/IEEE-bus command DET:REC POS



The *MIN PEAK* softkey activates the min peak detector.

IEC/IEEE-bus command DET:REC NEG



The *QUASIPeAK* softkey selects the quasi-peak detector.

The IF bandwidth is adapted as a function of the frequency range. The coupling of the IF bandwidth to the frequency range can be cancelled using softkey *QP RBW UNCOUPLED*.

IEC/IEEE-bus command DET:REC QPE

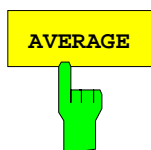

The *AVERAGE* softkey activates the average detector.

IEC/IEEE-bus command DET:REC AVER



The *CISPR AVERAGE* softkey activates the weighting average detector according to CISPR 16-1. The IF bandwidth is automatically set to the required value according to the receiving frequency. This coupling can be cancelled by the *QP RBW UNCOUPLED* softkey.

IEC/IEEE-bus command: DET:REC CAV

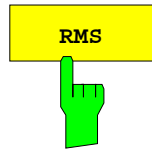

The *RMS* softkey activates the rms detector.

IEC/IEEE-bus command DET:REC RMS

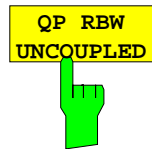

The *QP RBW UNCOUPLED* softkey cancels the coupling of the IF bandwidth to the frequency range with activated quasi peak or CISPR average detector.

IEC/IEEE-bus command BAND:AUTO OFF

Setting the Measurement Time

The measurement time can be set in steps of 1-2-5 in the range 100 μ s to 100 s. A measurement time of 15 s is available in addition.

The measurement time is the time during which R&S ESCI measures the input signal and forms a measurement result weighted by the selected detector. The measurement time does not include settling times of the synthesizer and the IF filter. R&S ESCI automatically waits until transients are over. When the quasi-peak detector is used, the minimum measurement time is 1 ms. When the CISPR average detector is used, the minimum measurement time is 100 ms.

With the average, RMS, AC video or min/max peak detector the smallest settable measurement time depends on the bandwidth.

Bandwidth	Shortest measurement time AV, RMS	Shortest measurement time PK+, PK-
≤ 10 Hz	1 sec	10 msec
100 Hz	100 msec	1 msec
200 Hz	50 msec	1 msec
1 kHz	10 msec	0,1 msec
9 kHz	1 msec	0,1 msec
≥ 100 kHz	0,1 msec	0,05 msec

RECEIVER menu

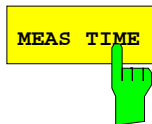

The *MEAS TIME* softkey activates the entry field for the measurement time.

Note: This softkey is also available in the Receiver menu.

IEC/IEEE-bus command SWE:TIME 100ms

Effect of measurement time with different weighting modes:

MIN/MAX PEAK measurement:

With peak weighting selected, the maximum or minimum level during the selected measurement time is displayed. The peak detector is reset at the beginning of each measurement. At the end of the measurement time the maximum or minimum level occurred during the measurement time is displayed. Since the peak detector of R&S ESCI is a digital detector, discharging is irrelevant even with long measurement times.

Unmodulated signals can be measured with the shortest possible measurement time. When pulses are measured, the selected measurement time must be long enough for at least one pulse to occur during the measurement time.

Average measurement:	With average detection selected, the video voltage (envelope of IF signal) is averaged during the measurement time. Averaging is digital, i.e. the digitized values of the video voltage are summed up and divided by the number of samples at the end of the measurement time. This corresponds to a filtering with a rectangular window in the time domain and a filtering with $\sin x/x$ characteristic in the frequency domain. With unmodulated signals the shortest possible measurement time can be selected. With modulated signals the measurement time is determined by the lowest modulation frequency to be averaged. With pulse signals, the selected measurement time should be long enough for sufficient number of pulses (>10) to occur in the measurement window for averaging.
CISPR average measurement:	With a CISPR average measurement, the maximum value of the weighted signal during the measurement time is displayed. The relatively long time constants used with CISPR average detectors result in long measurement times in order to obtain a correct measurement result. If unknown signals are measured, the measurement time should be at least one second so that pulses down to a frequency of 5 Hz are correctly weighted. After a frequency change or a modification of the attenuation, the receiver waits until the lowpass has settled before the measurement time starts. The measurement time is selected depending on the IF bandwidth and the characteristics of the signal to be measured. Unmodulated sinusoidal signals as well as signals with high modulation frequency can be measured within a short time. Slowly fluctuating signals or pulse signals require longer measurement times.
RMS measurement:	With RMS weighting the same applies to the measurement time as with the average measurement.
Quasi-peak measurement:	With quasi-peak measurements, the maximum value of the weighted signal during the measurement time is displayed. The relatively long time constants used with quasi-peak detectors entail long measurement times to obtain correct results. With unknown signals the measurement time should be at least 1 s. This ensures correct weighting of pulses down to a pulse frequency of 5 Hz. After internal switching, R&S ESCI waits until the measurement result has stabilized before it starts the actual measurement. Since the level does not change during a frequency scan, known signals (e.g. broadband RFI) can be correctly measured with a much shorter measurement time.
Measurement with several detectors:	If several detectors are used simultaneously, a measurement time suiting the slowest detector should be selected to obtain correct results for all detectors. It is therefore recommended to set a measurement time that matches the average detector when the peak and average detectors are used.

AF Demodulators

R&S ESCI provides demodulators for AM and FM signals. With these demodulators selected, a displayed signal can be monitored using the internal loudspeaker or external headphones.

DEMODO menu:

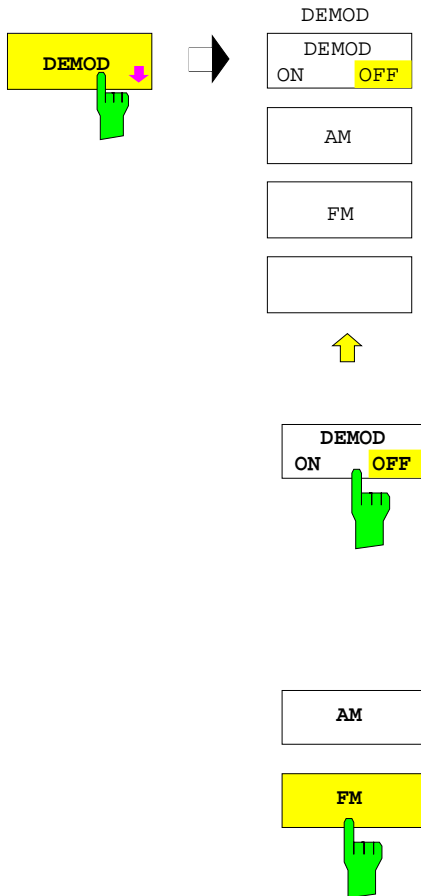

The *DEMODO* softkey calls a submenu in which the desired type of demodulation can be switched on.

The volume for loudspeaker and headphones is set by means of control knob on the front panel. The volume can also be remote-controlled (IEC/IEEE-bus command `SYST:SPE:VOL 0.7`).

Note: This softkey is available also in the *RECEIVER* menu.

The *DEMODO ON/OFF* softkey switches demodulation on/off.

IEC/IEEE-bus command `DEM OFF`
 (DEModulation ON automatically switched on with `DEM AM | FM`)

The *AM* and *FM* softkeys can be activated one at a time. They are used to set the desired demodulation type, FM or AM. .

IEC/IEEE-bus command `DEM AM | FM`

Data Reduction and Peak List

EMI measurements may involve much time because the time constants prescribed by the standard for the quasi-peak weighting require transients which lead to long measurement times per each value. In addition, the standards stipulate procedures for finding local EMI maxima such as shifting the absorbing clamp, variation of the test antenna height and rotating the DUT. Measuring with quasi-peak weighting at each frequency and for each setting of the test configuration would lead to unacceptably long measurement times. For this reason, R&S has developed a method which reduces the time-consuming measurements to a minimum with an optimum reliability of detection.

Data Reduction using the Subrange Maximum

The interference spectrum is first pre-analyzed in a fast prescan to optimize the duration of the measurement. Data reduction follows so that the time-consuming final measurement is performed at only some important frequencies:

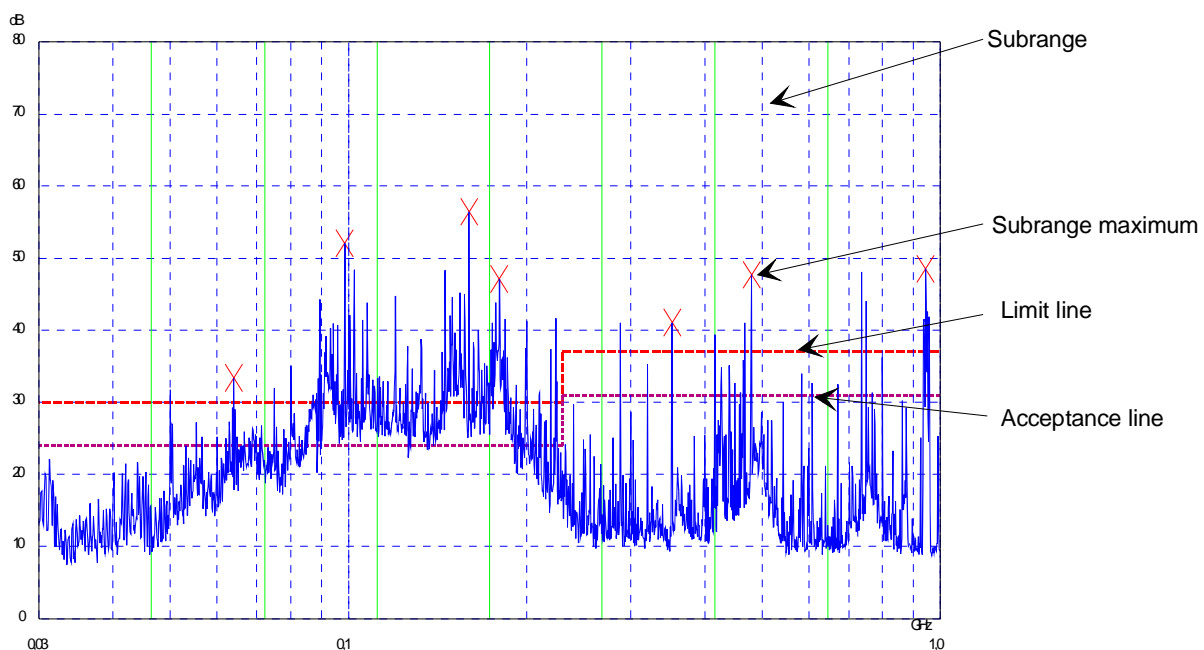

Fig. 4-1 Dividing the spectrum into eight subranges

Data reduction is of crucial importance. It is initiated by the user pressing a key after the prescan and then automatically performed by the receiver. Data reduction is used to select frequencies with a very high interference level. Several data reduction methods are used:

- Acceptance analysis, i.e. the interference spectrum is further analyzed at frequencies with levels above a line parallel to a limit line.
- Generating subrange maxima, i.e. the interference spectrum is further analyzed at frequencies with the highest interference level of a frequency subrange (search method SUBRANGES).
- Determination of a specific number of peak values relative to the limit lines with the level values being independent of their frequency spectral distribution (search method PEAKS).

For generation of subrange maxima, the whole frequency range is divided into equidistant subranges. A subrange maximum is determined for each subrange (search method SUBRANGES).

Determining the level maxima irrespective of their distribution in the frequency spectrum (search mode PEAKS) is suitable for measurement regulations that demand determination of the relatively highest level irrespective of the distribution in the measured frequency range, e.g. FCC.

If the prescan is performed in parallel with several detectors, typically with peak value and average value, the maxima are determined separately for the two detectors so that the distribution of narrowband and wideband sources of interference can be taken into account. For example, the frequency of the maximum determined with the average detector can be used for the final measurement performed with this detector and the frequency found in the prescan carried out with the peak detector is taken for the final measurement using the quasi-peak detector.

Consideration of the limit lines ensures that the final measurement is not performed at frequencies at which the inference level is far below the limit value. The margin between the acceptance line and the limit line can be selected by the user in dB as the *MARGIN*. Each limit line is allocated to a trace, i.e. different limit lines are taken for the different detectors.

Two values should therefore be defined for this purpose:

- the number of subranges or highest level values (*NO OF PEAKS* in the range from 1 to 500; default value: 25)
- the acceptance margin (*MARGIN*; default value: 6 dB). It is valid for all limit lines.

As an alternative method, it is possible to preset a list of frequencies at which the final measurements are performed. A typical application is, for example, the statistical analysis of several units.

The peak list can be either edited manually or can be filled with desired values by adopting the marker values.

If no limit lines are activated, the measurement procedure is as if all measured values would exceed the limit line.

FINAL MEAS menu (left side menu)

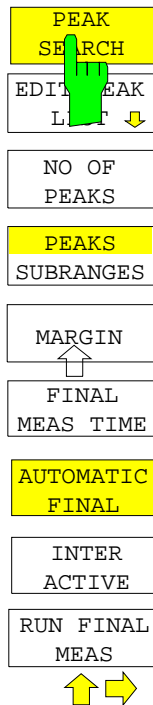

The *PEAK SEARCH* softkey starts the determination of the subrange maxima list from the available scan results. The procedure can be repeated as often as desired to try out different settings of margin and number of subranges.

IEC/IEEE-bus command : CALC : PEAK

The following table shows the peak list which is determined by the peak-search function after the prescan:

EDIT PEAK LIST (Prescan results)			
Trace1: 014QP			
Trace2: 014AV			
TRACE3: ---			
TRACE	FREQUENCY	LEVEL dBpT	DELTA LIMIT dB
1 Average	80.0000 MHz	35.34	-3.91
2 Average	89.4800 MHz	38.83	-0.91
1 Max Peak	98.5200 MHz	47.53	-2.63
2 Average	98.5200 MHz	46.63	6.47
1 Max Peak	100.7200 MHz	54.14	3.88
2 Average	102.3200 MHz	50.89	10.56
1 Max Peak	113.2400 MHz	49.68	-1.08
2 Average	116.9200 MHz	44.81	3.91
1 Max Peak	125.8800 MHz	55.01	3.78
2 Average	125.8800 MHz	53.55	12.33
1 Max Peak	138.4800 MHz	45.68	-5.95
2 Average	138.4800 MHz	42.17	0.53
2 Average	144.0400 MHz	43.72	1.90
2 Average	167.0400 MHz	44.77	2.32
2 Average	176.2400 MHz	45.52	2.83
1 Max Peak	200.4800 MHz	52.49	-0.75
2 Average	200.4800 MHz	48.76	5.51
1 Max Peak	210.2800 MHz	60.55	7.09
2 Average	226.5600 MHz	59.02	15.24
2 Average	239.0000 MHz	48.59	4.75

FINAL MEAS menu (left side menu)

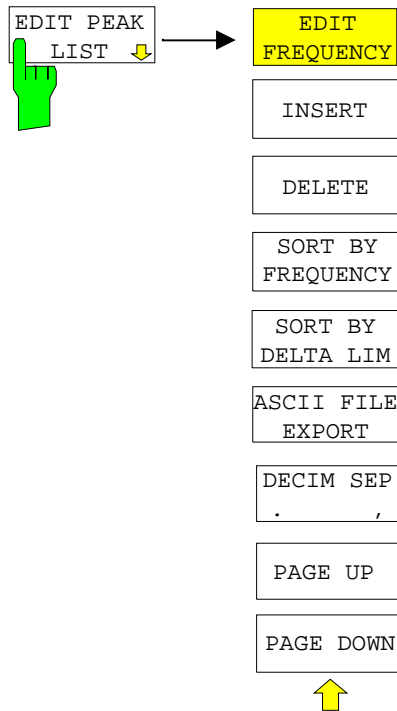

The *EDIT PEAK LIST* softkey calls the *EDIT PEAK LIST* submenu used for editing the peak list. A frequency list can thus be predefined and a final measurement carried out at these frequencies.

A peak list can also be generated by adopting the marker values (see section "Changing the device settings with Markers marker →")

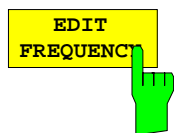

The *EDIT FREQUENCY* softkey activates table *EDIT PEAK LIST*. The cursor marks the upper field of column *FREQUENCY*.

IEC/IEEE-bus command --

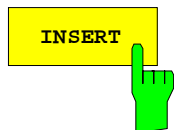

The *INSERT* softkey creates an empty line above the current cursor position

IEC/IEEE-bus command --

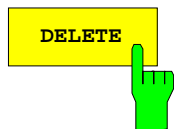

The *DELETE* softkey erases the complete line at the cursor position. Before deletion, a message appears requesting confirmation..

IEC/IEEE-bus command --

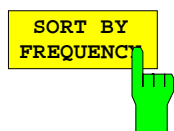

The softkey *SORT BY FREQUENCY* sorts the table in a descending order according the entries in the *FREQUENCY* column.

IEC/IEEE-bus command --

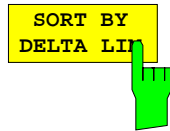

The softkey *SORT BY DELTA LIMIT* sorts the table in a descending order according to the entries in the *DELTA LIMIT* column .

IEC/IEEE-bus command --



The *ASCII FILE EXPORT* softkey stores the final measurement data in a file with ASCII format on a floppy disk.

IEC/IEEE command `FORM ASC;`
`MMEM:STOR:FIN 1, 'FINAL.DAT'`

The file consists of the header containing important scaling parameters, several data sections containing the scan settings and a data section containing the results of the final measurement.

The data of the file header consist of three columns, each separated by a semicolon:
 parameter name; numeric value; basic unit

The data section for the trace date starts with the keyword "Trace <n> Final" (<n> = number of stored trace), followed by the measured data in one or several columns which are also separated by a semicolon.

This format can be read in from spreadsheet calculation programs, e.g. MS-Excel. It is necessary to define ';' as a separator.

Note: *Different language versions of evaluation programs may require a different handling of the decimal point. It is therefore possible to select between separators '.' (decimal point) and ',' (comma) using softkey DECIM SEP.*

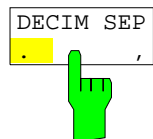

The *DECIM SEP* softkey selects the decimal separator between '.' (decimal point) and ',' (comma) with floating-point numerals for the function ASCII FILE EXPORT.

With the selection of the decimal separator different language versions of evaluation programs (e.g. MS-Excel) can be supported.

IEC/IEEE-bus command `FORM:DEXP:DSEP POIN`

Structure of the ASCII file:

RECEIVER mode, final measurement data:

	Content of file	Description
File header	Type; R&S ESCI;	Instrument model
	Version;2.32;	Firmware version
	Date;03.Aug 2004;	Date record storage date
	Mode;Receiver;	Instrument operating mode
	Start;10000;Hz	Start/stop of the display range.
	Stop;100000;Hz	Unit: Hz
	x-Axis;LIN;	Scaling of x axis linear (LIN) or logarithmic (LOG)
	Scan Count;1;	Number of scans set
	Transducer;TRD1;	Transducer name (if switched on)
	Scan 1:	Loop over all defined scan ranges (1-10)
	Start;150000;Hz	Range - start frequency in Hz
	Stop;1000000;Hz	Range - stop frequency in Hz
	Step;4000;Hz	Range - step width in Hz for linear step width or in % (1-100) for logarithmic step width
	RBW;100000;Hz	Range - resolution bandwidth
	Meas Time;0.01;s	Range - measurement time
	Auto Ranging;ON;	Auto ranging on - or off for current range
	RF Att;20;dB	Range - input attenuation
Auto Preamp;OFF;	Auto Preamp on or off for current range	
Preamp;0;dB	Range - preamplifier on (20dB) or off (0dB)	
Data section of the file	TRACE 1 FINAL:	Selected trace
	Trace Mode;CLR/WRITE;	Trace mode: CLR/WRITE,AVERAGE,MAX HOLD,MIN HOLD, VIEW, BLANK
	Final Detector, QUASI PEAK;	Final detector MAX PEAK, MIN PEAK, RMS, AVERAGE, QUASI PEAK, AC VIDEO
	x-Unit;Hz;	Unit of x values:
	y-Unit;dBuV;	Unit of y values:
	Final Meas Time;1.000000;s	Final measurement time
	Margin;6.000000;s	Margin
	Values;8;	Number of test points
	2;154000.000000;81.638535;	Measured values: <Trace>;<x-value>, <y-value>; <phase>; <ground>
	15.638535;N;GND	
	1;158000.000000;86.563789;	
	7.563789;N;GND	
	2;1018000.000000;58.68987	Phase and protective grounding are output only if a line impedance stabilization has been activated. They specify the setting at which the maximum RFI level at the associated frequency was found.
	3;-1.310127;N;GND	
	...	

Example :

```
Type;ESCI;
Version;2.23;
Date;03.Mar 04;
Mode;Receiver;
Start;150000.000000;Hz
Stop;30000000.000000;Hz
x-Axis;LOG;
Scan Count;1;
Transducer;;
Scan 1:
Start;150000.000000;Hz
Stop;30000000.000000;Hz
Step;4000.000000;Hz
RBW;9000.000000;Hz
Meas Time;0.001000;s
Auto Ranging;OFF;
RF Att;10.000000;dB
Auto Preamp;OFF;
Preamp;0.000000;dB
TRACE 1 FINAL:
Trace Mode;CLR/WRITE;
Final Detector;MAX PEAK;
TRACE 2 FINAL:
Trace Mode;CLR/WRITE;
Final Detector;AVERAGE;
x-Unit;Hz;
y-Unit;dBuV;
Final Meas Time;1.000000;s
Margin;6.000000;dB
Values;11;
2;154000.000000;81.638535;15.638535;N;GND
1;158000.000000;86.563789;7.563789;N;GND
2;1018000.000000;58.689873;-1.310127;N;GND
2;302000.000000;63.177345;-2.822655;L1;GND
2;3294000.000000;56.523022;-3.476978;N;GND
2;1122000.000000;53.849747;-6.150253;N;GND
2;10002000.000000;47.551216;-12.448784;N;GND
1;3390000.000000;59.762917;-13.237083;N;GND
1;9998000.000000;58.309189;-14.690811;L1;GND
2;20002000.000000;45.142456;-14.857544;L1;GND
2;7502000.000000;36.406967;-23.593033;L1;GND
```

FINAL MEAS menu (left side menu)

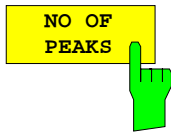

The *NO OF PEAKS* softkey activates the entry field of the number of subranges or peaks for the determination of the peak list. The range of values is 1 to 500.

IEC/IEEE-bus command :CALC:PEAK:SUBR 1 to 500

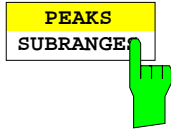

The *PEAKS SUBRANGES* softkey defines the search method with which maxima are searched for within a scan.

PEAKS Determination of a specific number of peak values relative to the limit lines with the level values being independent of their frequency spectral distribution.

SUBRANGES Generating subrange maxima, i.e. the interference spectrum is further analyzed at frequencies with the highest interference level of a frequency subrange.

IEC/IEEE-bus command :CALC:PEAK:METH SUBR|PEAK

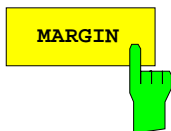

The *MARGIN* softkey activates the entry field of the margin, i.e. of an additional acceptance threshold for the determination of the peak list. The limit line currently used is shifted by this amount for defining the maxima. The range of values is -200 dB to 200 dB.

IEC/IEEE-bus command :CALC:PEAK:MARG -200dB to 200dB



The *FINAL MEAS TIME* softkey activates the entry field of the time of final measurement.

IEC/IEEE-bus command :SWEep:TIME:FME <num_value>



The *AUTOMATIC FINAL* softkey selects the automatic routine for the final measurement. This routine is run according to the available frequency list without user interaction..

IEC/IEEE-bus command :FME:AUTO ON

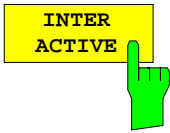

The *INTERACTIVE* softkey selects the following sequence for the final measurement:

- A frequency from the frequency list is set on the receiver together with the associated settings from the corresponding partial scan.
- The marker is set on this frequency in the scan diagram.
- The final measurement sequence switches to the *Interrupted* status.
- The signal can be exactly analyzed by modifying the receiver settings.
- *CONTINUE AT HOLD* starts the actual final measurement, the receiver settings being restored except the frequency.
- The current frequency replaces the original one in the frequency list (drifting interference sources)
- Next frequency of frequency list.....

Note: With the *AUTOMATIC FINAL* softkey in the *CONTINUE FINAL MEAS* submenu a switchover can be made to the automatic mode before the measurement is started anew.

IEC/IEEE-bus command : FMEA:AUTO OFF

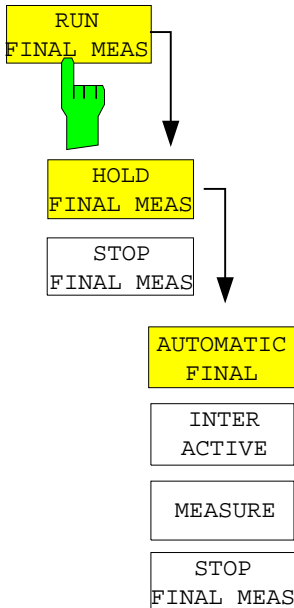

The *RUN FINAL MEAS* softkey starts the final measurement sequence as described above. The *HOLD FINAL MEAS* submenu is called.

The detectors used for the final measurement replace those used in the list or for the prescan. The out-of-limit condition is shown by a plus sign preceding the values in the *DELTA LIMIT* column (see table below).

IEC/IEEE-bus command --

Note: The final measurement function is only available in the manual mode. For operation under program control it is preferable to read the prescan results and the data-reduced peak list, if any, from the R&S ESCI with the controller and carry out the individual measurements with the controller. This considerably makes the control of the interactive mode easier.

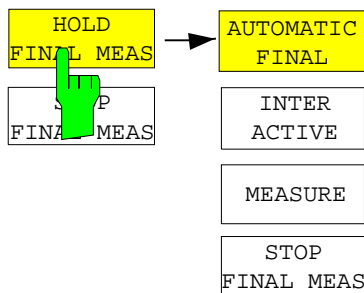

The *HOLD FINAL MEAS* softkey interrupts the automatic run of the final measurement.

The *CONTINUE FINAL MEAS* submenu appears.

With the final measurement halted all receiver settings can be modified for example for examining the signal in detail.

The mode of the measurement (automatic or interactive) can again be selected.

The final measurement can be started with the *MEASURE* softkey.

IEC/IEEE-bus command --



The *AUTOMATIC FINAL* softkey selects the automatic mode for the final measurement (see above).

IEC/IEEE-bus command :FME:AUTO ON

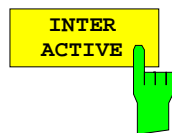

The *INTERACTIVE* softkey selects the interactive mode for the final measurement as described above.

IEC/IEEE-bus command :FME:AUTO OFF

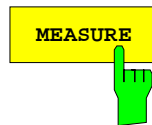

The *MEASURE* softkey continues with the final measurement. The final measurement starts at the next frequency entry on the peak list or at a marked frequency if one or several lines have been skipped with the *SKIP FREQUENCY* softkey.

IEC/IEEE-bus command --



The *STOP FINAL MEAS* softkey halts the final measurement. The final measurement starts from the beginning on a new start. The previously collected data are lost.

IEC/IEEE-bus command --

The peak list available after the final measurement:

EDIT PEAK LIST (Final Measurement Results)			
Trace1: 014QP			
Trace2: 014AV			
TRACE3: ---			
TRACE	FREQUENCY	LEVEL dBpT	DELTA LIMIT dB
1 Average	80.0000 MHz	29.99	-9.25
2 Average	89.4800 MHz	35.64	-4.09
1 Quasi Peak	98.5200 MHz	49.94	-0.22
2 Average	98.5200 MHz	48.32	8.15
1 Quasi Peak	100.7200 MHz	55.33	5.07
2 Average	102.3200 MHz	50.86	10.53
1 Quasi Peak	113.2400 MHz	42.50	-8.26
2 Average	116.9200 MHz	44.44	3.53
1 Quasi Peak	125.8800 MHz	54.91	3.68
2 Average	125.8800 MHz	53.86	12.64
1 Quasi Peak	138.4800 MHz	41.83	-9.81
2 Average	138.4800 MHz	39.38	-2.25
2 Average	144.0400 MHz	40.77	-1.04
2 Average	167.0400 MHz	44.82	2.37
2 Average	176.2400 MHz	46.56	3.87
1 Quasi Peak	200.4800 MHz	50.93	-2.31
2 Average	200.4800 MHz	48.27	5.02
1 Quasi Peak	210.2800 MHz	58.71	5.25
2 Average	226.5600 MHz	59.07	15.29
2 Average	230.0000 MHz	46.90	3.05

Automatic Final Measurement with **THRESHOLD SCAN**

The interference spectrum is first pre-analyzed in a fast prescan to optimize the duration of the measurement. If the measured level exceeds a limit line, or violates a margin defined for this line, the time-consuming final measurement is performed. The final measurement is, therefore, carried out only for a reduced number of frequencies of interest. For this measurement, each scan trace to be taken into account has to be assigned a limit line, and the limit line and the limit check function have to be activated in the *LIMIT LINE* menu.

The prescan is interrupted immediately for each final measurement to be performed, i.e. the final measurement immediately follows the prescan measurement. In the case of drifting or fluctuating interferers, this increases the probability that the signal of interest will be reliably detected in the final measurement.

If the narrowband/broadband discrimination function is activated (NB/BB DISCR softkey), the receiver automatically selects the detector to use in the final measurement. To this end, the receiver compares the positive and the negative peak value obtained in the prescan. If the difference between the two values exceeds a user-selected threshold, a broadband interferer is assumed, and the quasi-peak detector is used in the final measurement. If the difference falls below this threshold, a narrowband interferer is assumed, and the average detector is used in the final measurement. (The receiver automatically determines the positive and the negative peak value during the prescan.)

The value obtained in the final measurement is added to the peak list, where it replaces the result of the prescan. With *NO OF PEAKS*, the maximum number of peak values to be included in the list can be defined. If this number is attained, the prescan will be continued, but no further final measurements will be performed.

The *THRESHOLD SCAN* submenu is called from the *RECEIVER* main menu:

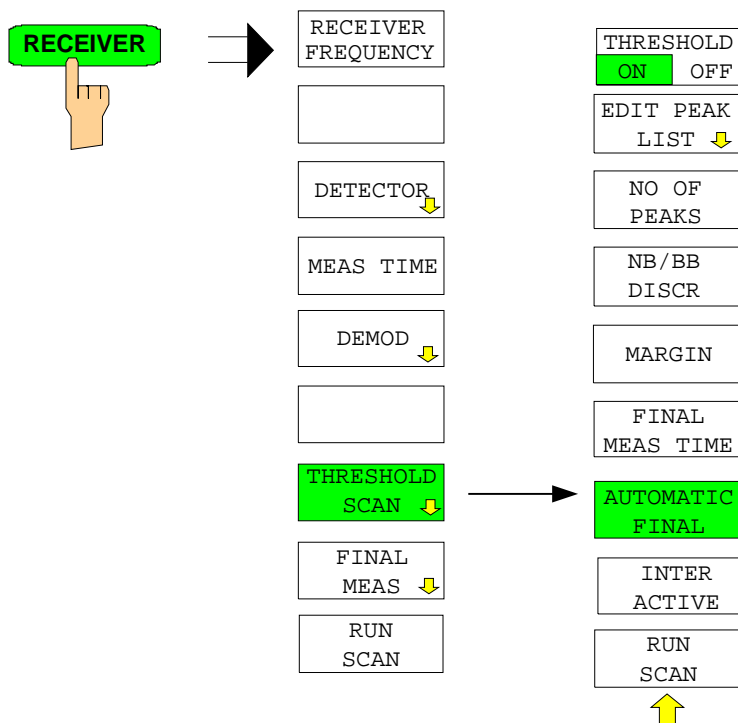

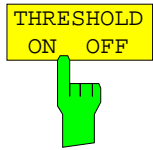

The *THRESHOLD ON OFF* softkey activates or deactivates the *THRESHOLD SCAN* measurement function. This function will also be activated on opening the submenu with the *THRESHOLD SCAN* softkey from the *RECEIVER* main menu.

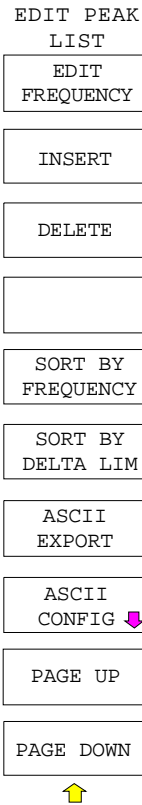

The *EDIT PEAK LIST* softkey calls the *EDIT PEAK LIST* submenu used for editing the peak list.

Further functions relating to the peak list are described in the operating manual, section "*Data Reduction by Generating Subrange Maxima*".

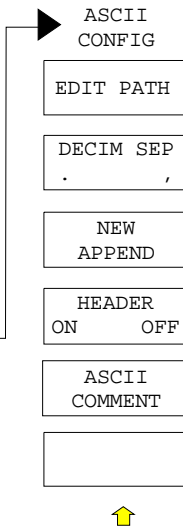

With the *NO OF PEAKS* softkey, you can enter the number of final measurement peaks to be stored. Numbers between 1 and 500 can be entered. If the selected number is attained, no further final measurements will be performed.

IEC/IEEE-bus command :CALC:PEAK:SUBR 1...500

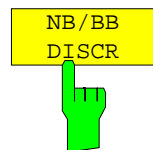

With the *NB/BB DISCR* softkey, you can enter the decision threshold to be used by the analyzer to discriminate between broadband and narrowband interference. Values between 0 dB and 200 dB can be entered.

IEC/IEEE-bus command :FMEasurement:NBBB ON | OFF
:FMEasurement:NBBB:LEVel 0...200dB

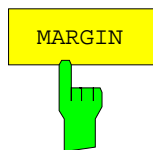

The *MARGIN* softkey activates the entry field of the margin, i.e. of an additional acceptance threshold for the determination of the peak list. The limit line currently used is shifted by this amount for defining the maxima. The range of values is -200 dB to 200 dB.

IEC/IEEE-bus command :CALC:PEAK:MARG -200dB...200dB

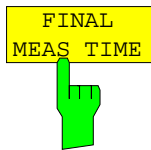

The *FINAL MEAS TIME* softkey activates the entry field of the time of final measurement.

IEC/IEEE-bus command :SWE:TIME:FME <num_value>

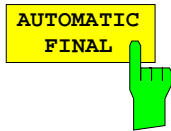

The *AUTOMATIC FINAL* softkey activates the automatic mode for the final measurement, i.e. a final measurement will be performed automatically and immediately each time a value out of limit is detected.

IEC/IEEE-bus command :FMEasurement:AUTO ON

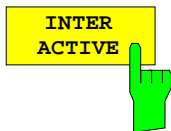

The *INTERACTIVE* softkey selects the following sequence for the final measurement:

- The prescan is interrupted – *HOLD SCAN* state.
- The bar graph measurement is started in the free running mode.
- The signal can be exactly analyzed by modifying the receiver settings.
- The actual final measurement is started, the receiver settings being restored except the frequency.
- The current frequency replaces the original one in the frequency list (drifting interference sources).
- The prescan is continued at the frequency at which it was interrupted....

Note: *With the AUTOMATIC FINAL softkey in the CONTINUE FINAL MEAS submenu a switchover can be made to the automatic mode before the measurement is started anew.*

IEC/IEEE-bus command :FMEasurement:AUTO OFF

Sequence for *AUTOMATIC FINAL*:

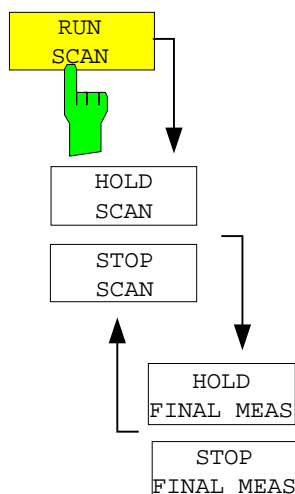

The *RUN SCAN* softkey starts the prescan. The *HOLD SCAN* submenu is called.

If an out-of-limit value is detected, the receiver automatically goes to the *HOLD SCAN* state and starts the final measurement. The *HOLD FINAL MEAS* submenu comes up. On completion of the final measurement, the receiver continues the prescan, and the *HOLD SCAN* submenu is displayed again.

Sequence for *INTERACTIVE*:

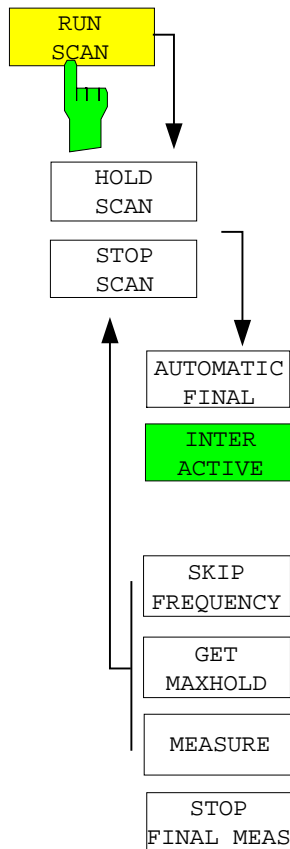

The *RUN SCAN* softkey starts the prescan. The *HOLD SCAN* submenu is called.

If an out-of-limit value is detected, the receiver automatically goes to the *HOLD SCAN* state. A submenu with several options for the final measurement comes up:

- *AUTOMATIC FINAL* activates the automatic final measurement mode for the rest of the test run.
- *SKIP FREQUENCY* skips the final measurement and continues with the prescan.
- *GET MAXHOLD* accepts the highest level measured during the *HOLD SCAN* state as the result of the final measurement and continues the prescan. (The level value in question is displayed as a small bar in the bar graph.)
- *MEASURE* starts the final measurement, the receiver settings being restored except the frequency.
- *STOP FINAL MEAS* aborts the final measurement and the prescan.

Selection of Detectors for Final Measurement

The selection of detectors for the final measurement is made in the right side menu *TRACE DETECTOR* (see section "Selection and setting of traces ").

The detectors to be used for the final measurement can be set here for each trace, i.e. any combination of prescan and final measurement is possible. The required flexibility is thus obtained for the diverse test specifications which are covered by means of the R&S ESCI.

In the *THRESHOLD SCAN* mode, with the *NB/BB DISCR* function active, the receiver automatically selects the detector to be used in the final measurement on the basis of the results obtained in the prescan.

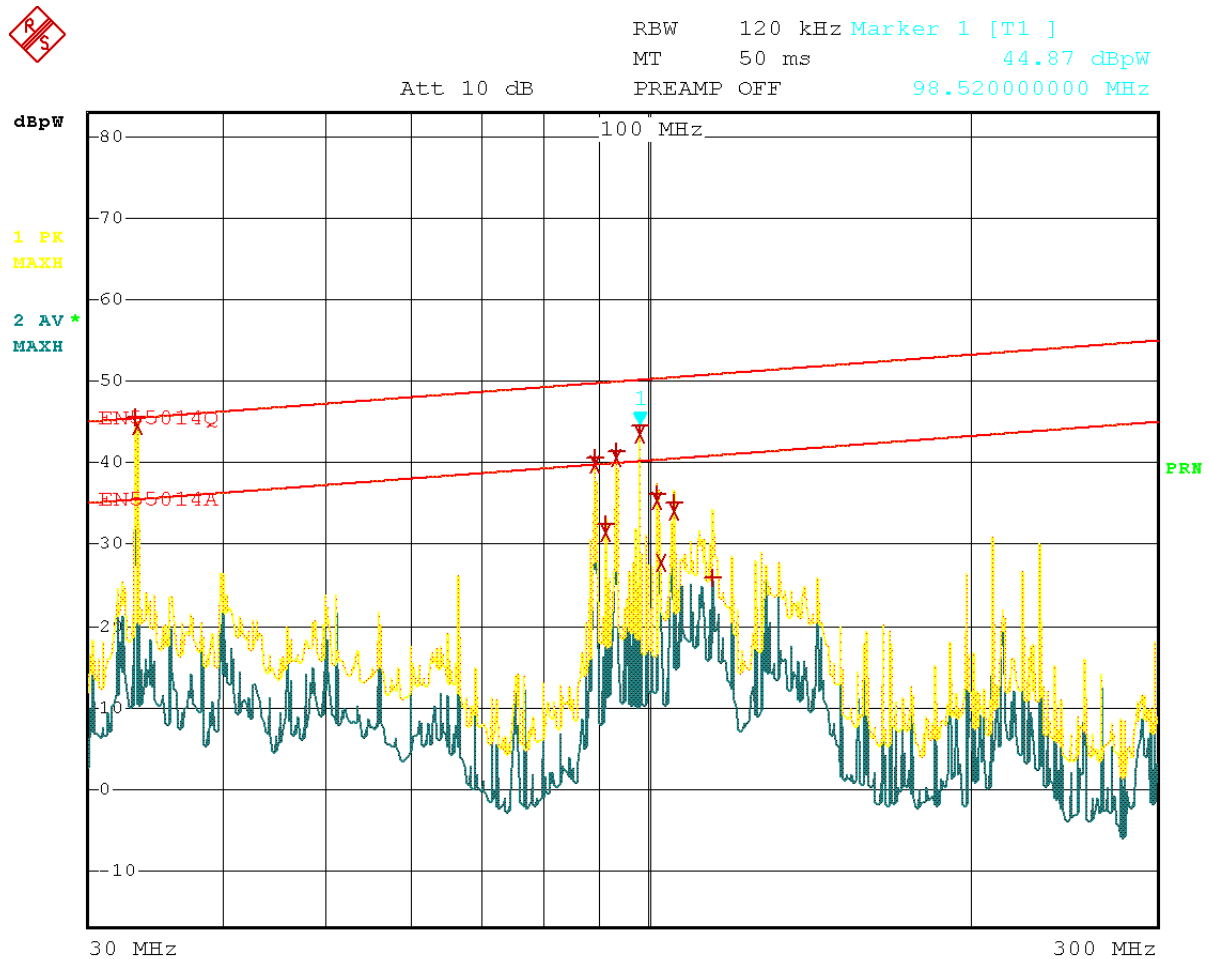

Date: 8.AUG.2001 16:41:37

Fig. 4-2 Results of prescan and final measurement

Automatic Control of Line Impedance Stabilization Networks

The selected phases are controlled during the prescan and the final measurement via the USERPORT with the LISN switched on.

Only one phase and one PE setting (1 out of n) can be selected for the prescan. Any number of settings can be selected for the final measurement (m out of n).

All selected phase/PE combinations are measured during the final measurement and the maximum value is determined.

FINAL MEAS menu (right side menu)

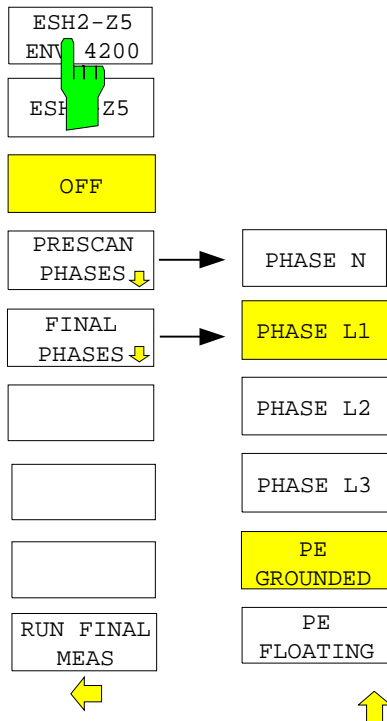

The LISN softkey opens the submenu for automatic control of V-networks (LISNs)

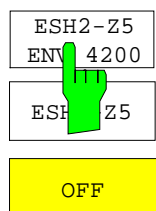

Softkeys *ESH2-Z5/ENV 4200*, *ESH3-Z5* and *OFF* allow to select the V-network to be controlled via the user port.

ESH2-Z5/ENV 4200 four-line V-network is controlled,

ESH3-Z5 two-line V-network is controlled,

OFF remote control is deactivated.

IEC/IEEE-bus command

:INPut:LISN[:TYPE] TWOPhase | FOURphase | OFF

 → The *PRESCAN PHASES* and *FINAL PHASES* softkeys open the submenu for the selection of phase and protective earth setting.

 → *PRESCAN PHASES*: Softkeys *ESH2-Z5/ENV 4200*, *ESH3-Z5* and *OFF* or *PHASE N*, *PHASE L1*, *PHASE L2* and *PHASE L3* as well as *PE GROUNDED* and *PE FLOATING* are toggle keys. Only one of them can be activated at a time.

FINAL PHASES: All combinations of phases and PE setting are possible.

PHASE N	Softkeys <i>PHASE N</i> , <i>PHASE L1</i> , <i>PHASE L2</i> and <i>PHASE L3</i> select the phase of the V-network on which the RFI voltage is to be measured.
PHASE L1	<i>PHASE N</i> RFI on phase N is measured,
PHASE L2	<i>PHASE L1</i> RFI on phase L1 is measured,
PHASE L3	<i>PHASE L2</i> RFI on phase L2 is measured (only for <i>ESH2-Z5/ENV 4200</i>),
	<i>PHASE L3</i> RFI on phase L3 is measured (only for <i>ESH2-Z5/ENV 4200</i>).

IEC/IEEE-bus command :INP:LISN:PHAS L1 | L2 | L3
| N

PE GROUNDED	Softkeys <i>PE GROUNDED</i> and <i>PE FLOATING</i> switch the protective earth conductor chokes on or off.
PE FLOATING	<i>PE GROUNDED</i> protective earth conductor choke switched off,
	<i>PE FLOATING</i> protective earth conductor choke switched on.

IEC/IEEE-bus command :INP:LISN:PEAR GRO | FLO

Settings made in the *PRESCAN PHASES* menu are immediately output at the user port. This way, the menu can be used to remote control the V-networks during manual measurements.

For automatic phase selection with the V-networks R&S ESH2-Z5 and R&S ESH3-Z5 the R&S ESCI user interface and the V-networks have to be connected via a control line:

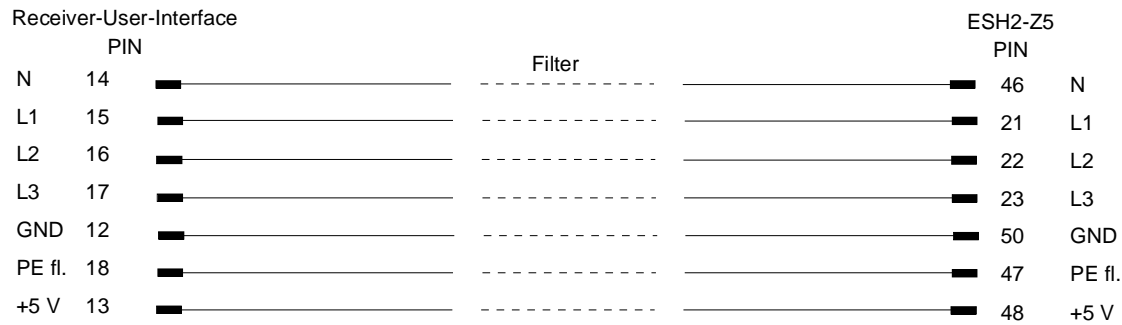

Fig. 4-3 Connection R&S ESCI with R&S ESH2-Z5 (for direct connection without a filter: cable EZ-13)

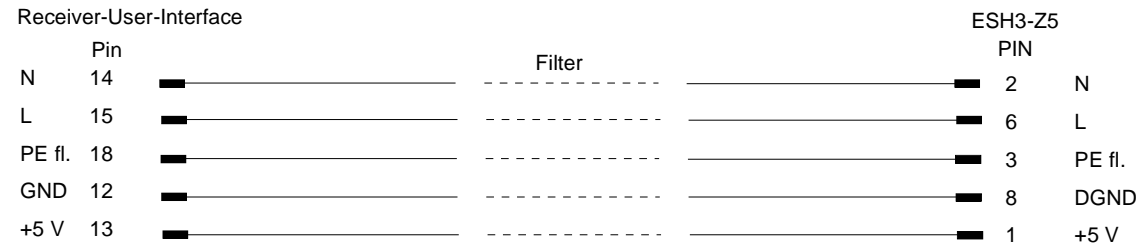

Fig. 4-4 Connection R&S ESCI with R&S ESH2-Z5 (for direct connection without a filter: cable EZ-14, model 02)

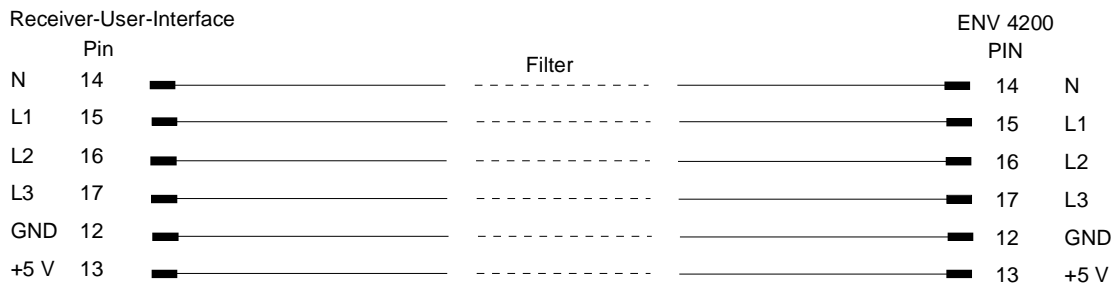

Fig. 4-5 Connection R&S ESCI with R&S ENV4200 (for direct connection without a filter: cable EZ-21)

For controlling the phase selection and the PE simulating network of the V-networks ESH2-Z5, ESH3-Z5 and ENV4200, the +5-V supply voltage and some control lines are to be routed through the wall of the shielded room.

The connection cables EZ-14 and EZ-5 can be provided for the 4-line V-network ESH2-Z5, the connection cable EZ-14 and EZ-6 for the two-line V-network ESH3-Z5 and the connection cables ES-14 and EZ-21 for the 4-line V-network ENV4200.

Suggested configuration of cables EZ-14/EZ-5/EZ-6/EZ-21

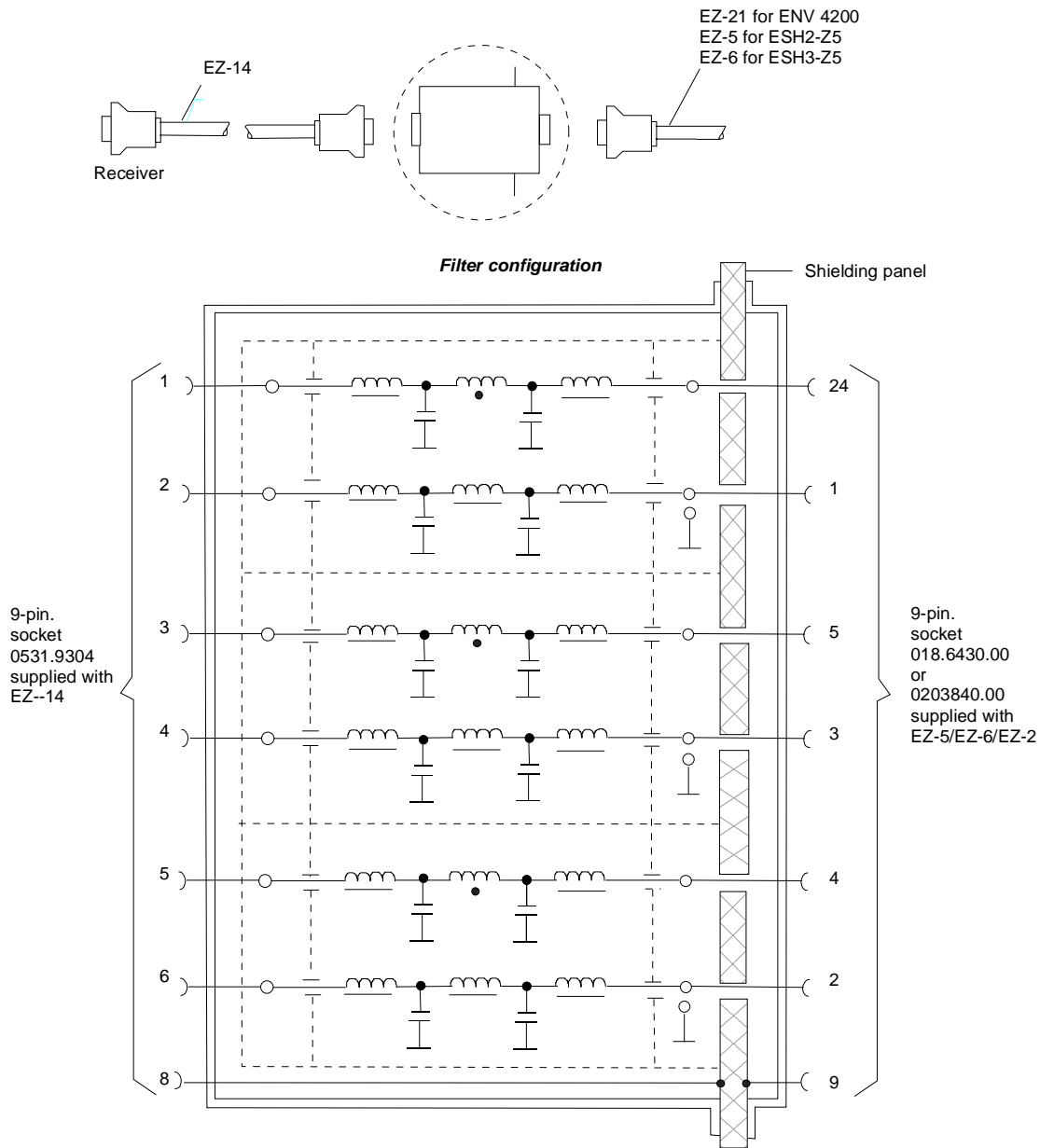

Fig. 4-6 Assignment of connection cables EZ-5, -6, -14 and -21 with AF filters for feeding the 5-V supply and the control information for the V-networks R&S ESH2-Z5, R&S ESH3-Z5 and R&S ENV4200 into a shielded room.

Note: When the R&S ESCI is used inside the shielded room, the filter configuration is omitted. The cable EZ-14 is then used for controlling the R&S ESH3-Z5, the cable EZ-13 for controlling the R&S ESH2-Z5, and the cable EZ-21 for controlling the R&S ENV4200.

Frequency Scan - SWEEP Key

Scan in the Frequency Domain

In the scan mode, R&S ESCI measures in a predefined frequency range with selectable step width and measurement time for each frequency.

Either the current receiver settings or the settings defined in the Scan table are used. Up to 10 subranges which need not be next to each other can be defined within one scan. The subranges are then scanned by R&S ESCI one after the other. Measurement ranges should not overlap. The parameters to be measured in each subrange can be selected independently (*SWEEP* menu, *SCAN TABLE* table).

Transducer factors or transducer sets and limit lines can be defined and displayed separately and are not part of the scan data record.

The scanned frequency range is defined by the start and stop frequency set independently of the scan table (*SCAN TABLE* table or *FREQUENCY* menu). A scan table can thus be defined for each measurement task, which can be stored and reloaded. The required frequency range can be defined by means of two parameters which can be set via keys so that no elaborate editing has to be done in the scan table.

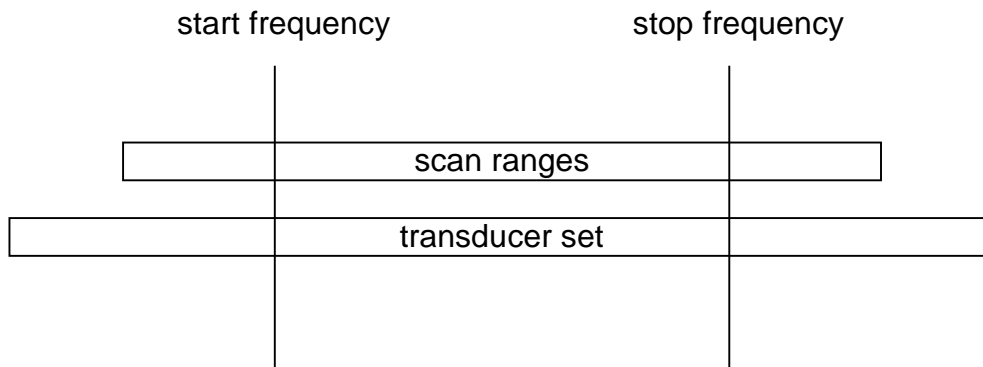

Fig. 4-7 Definition of scan range

Scanning is started with the *RUN* softkey. The scan can be performed as a single scan or continuously. In the case of single scan it is stopped when the stop frequency is reached. The continuous scan can be interrupted with the *HOLD SCAN* softkey or terminated with *STOP SCAN*.

The maximal number of measured frequencies is limited to 100.000. A maximum of 3 x 100.000 values (100.000 per detector) can be stored for postprocessing. If the scan subranges are defined so that more than the possible values would be measured, a respective message is output upon the scan start. Afterwards the scan is performed up to the maximum value.

At least one scan is defined in the list. Two subranges are defined in the default setup. All other parameters are shown in the following table:

Table 4-3 Default setup of scan table

	Range 1	Range 2
Start frequency	150 kHz	30 MHz
Stop frequency	30 MHz	1 GHz
Step width	Auto	Auto
IF bandwidth	9 kHz	120 kHz
Measurement time	1 ms	100 μ s
Auto ranging	OFF	OFF
Attenuation mode	Normal	Normal
RF attenuation	10 dB	10 dB
Preamplification	OFF	OFF

The diagram parameters to be defined are: start frequency 150 kHz, stop frequency 1 GHz, min. level 0 dB μ V, grid range log 100 dB, log. frequency axis and continuous scan.

The measurement parameters correspond to the settings recommended for overview measurements to CISPR 16.

Scan in the Time Domain

It is also possible to carry out the scan in the time domain, i.e. at a fixed frequency. Time domain analysis is generally used to examine the time characteristics of interferences. Evaluating the detected voltage with an oscilloscope is useful in order to correctly set the receiver measurement time. By doing so, you can determine whether and how strongly a narrowband interference fluctuates and whether it is amplitude-modulated or pulsed. You can also determine the pulse rate of a broadband interference. You can set the measurement time to a value that is greater than or equal to the reciprocal of the pulse rate.

Thermostat-controlled, software-controlled and other electrically controlled instruments generate discontinuous interferences. CISPR 14 and EN 55014 contain limit values for RFI voltage with click rate weighting in the range 0.15 MHz to 30 MHz. Clicks can usually be measured using click rate analyzers. However, a factor that is often critical in click rate measurements is the occurrence of successive pulses whose individual pulse heights cannot be exactly assigned by using the time constants of the quasi-peak weighting and can thus lead to the limit value being exceeded.

Time domain analysis can determine the pulse height and duration, which can be useful in such cases. It meets the requirements of CISPR 16-1 with regard to accuracy of the pulse duration measurement when the pulse duration is 10 ms and longer. Triggering can be performed internally – level set with display line – or externally with a TTL level.

The result memory capacity is 1 440 001 measured values per trace in time domain analysis. The measured values are stored internally and can, for example, then be analyzed by zooming in on them with the marker. At a measurement time of 5 ms per measured value, the memory depth is large enough to record the peak value and quasi-peak value continuously for two hours. Thus, measurement objects such as washing machines can be evaluated for click interferences.

Once measurement has been completed, the display of the measured values can be enlarged down to the individual measured values by using the zoom function. Thus, each individual click interferer can be evaluated in detail if necessary.

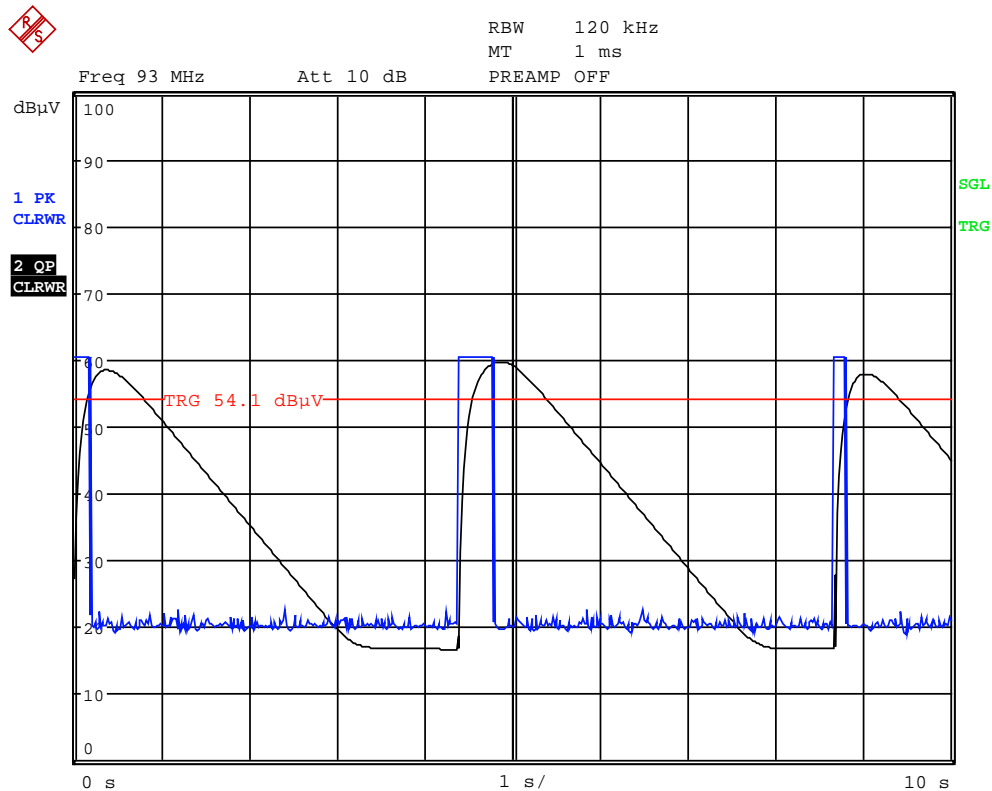

Fig. 4-8 Scan in the time range

Time domain analysis is started with the *RUN* softkey. It can be performed as a single operation (*SINGLE*) or as a repeating operation (*CONTINUOUS*). In *SINGLE* operation, time domain analysis stops after the total run time has elapsed. In *CONTINUOUS* operation, time domain analysis can either be interrupted with the *HOLD SCAN* softkey or stopped with the *STOP SCAN* softkey. The measurement itself is continuous, i.e. if the end of the graph is reached and recording starts again at the beginning of the graph, the measurement keeps running internally without any interruption.

Display of Measurement Results

Full-screen or split-screen mode can be selected for result display. In the full-screen mode, the result diagram covers the whole screen area.

In split-screen mode, the upper half of the screen displays the frequency and level readout, i.e. a bargraph. The diagram is displayed in the lower half

Up to 3 detectors can be measured simultaneously. They are assigned to traces 1 to 3. Since the detectors are set only once, it is not possible to measure with different detectors in different the subranges.

Entry of Scan Data

Pressing the *SWEEP* key opens the menu to configure and start the scan.

SWEEP menu

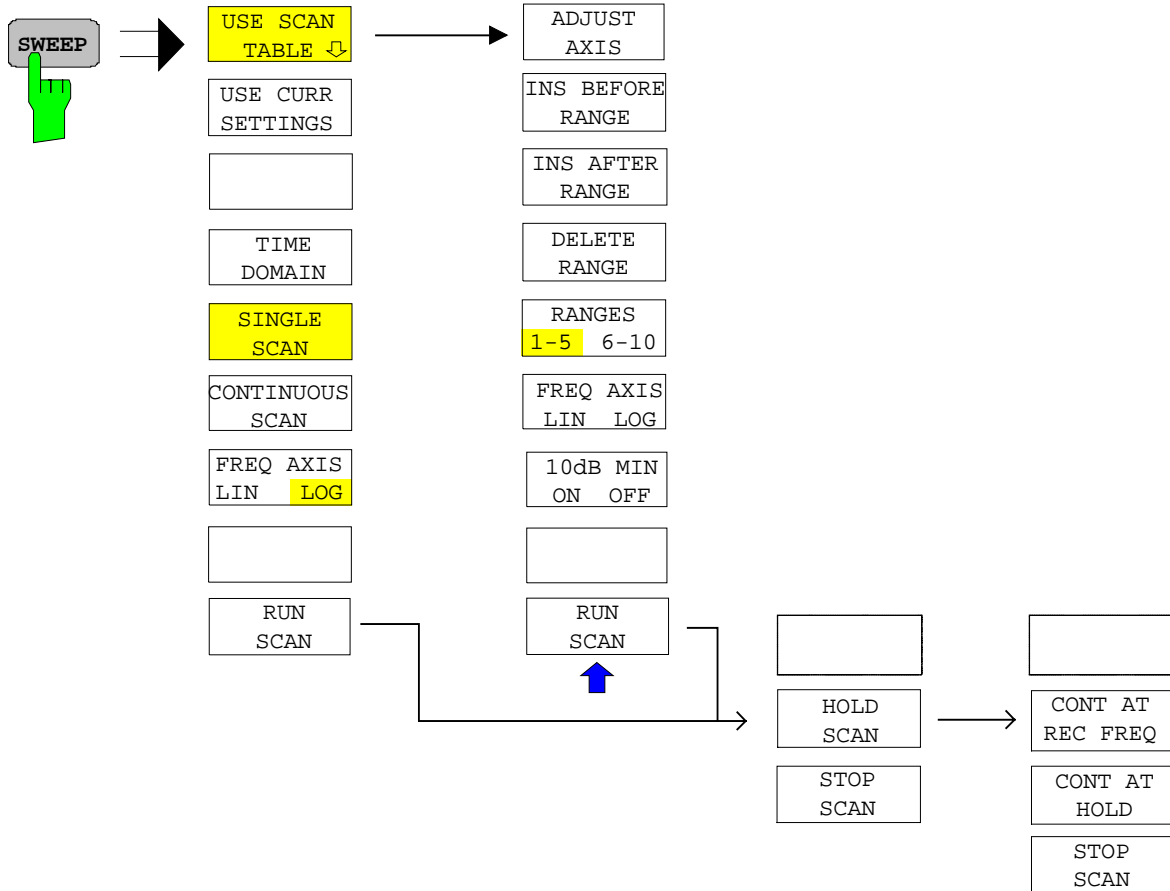

A scan is defined in the form of tables or it is performed using the current setting.

In the *SCAN* table, the scan subranges are defined . Each scan range is specified by start frequency, stop frequency, step width and the measurement parameters that are valid for this range.

The scan can be performed as a single scan or continuously (softkeys *SINGLE SCAN* and *CONTINUOUS SCAN*).

Scanning is started with the *RUN SCAN* softkey. .

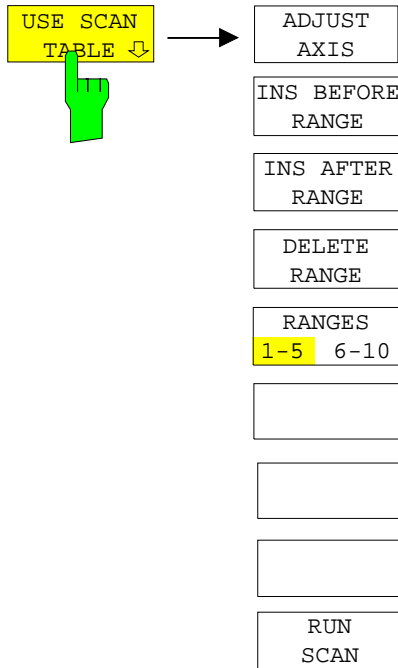

The *DEFINE SCAN* softkey *USE SCAN TABLE* opens a submenu where existing scan tables can be edited or new ones created. Tables with the current scan settings are displayed.

IEC/IEEE-bus command --

In the *SCAN TABLE* the parameters for the individual subranges can be set.

- Scan Start* start frequency of display range
- Scan Stop* stop frequency of display range
- Step Mode* step mode (linear or logarithmic frequency switching)
- Start* start frequency of scan range
- Stop* stop frequency of scan range
- Step Size* step size
- RES BW* resolution bandwidth
- Meas Time* measurement time
- Auto Ranging* automatic selection of attenuation
- RF Attn* RF attenuation
- Preamp* 20 dB preamplification
- Auto Preamp* auto range with preamplification

SCAN TABLE					
Scan Start	20.000 MHz				
Scan Stop	1.250 GHz				
Step Mode	LIN				
	RANGE1	RANGE2	RANGE3	RANGE4	RANGE5
Start	150.000 kHz	30.000 MHz	1.000 GHz		
Stop	30.000 MHz	1.000 GHz	2.000 GHz		
Step Size	4 kHz	40 kHz	400 kHz		
Res BW	9 kHz	120 kHz	1 MHz		
Meas Time	1 ms	100 us	100 us		
Auto Ranging	OFF	OFF	OFF		
RF Attn	10 dB	10 dB	10 dB		
Preamp	OFF	OFF	OFF		
Auto Preamp	OFF	OFF	OFF		

Scan Start - start frequency of display range

Range is f_{min} to $f_{max} - 10$ Hz

This value can also be set in the *FREQ* menu (*START* softkey).

IEC/IEEE-bus command `FREQ:STAR 20 MHz`

Scan Stop - stop frequency of display range

Range is f_{\min} to f_{\max} .

This value can also be set in the *FREQ* menu (*STOP* softkey).

IEC/IEEE-bus command `FREQ:STOP 1250 MHz`

Step Mode - selection of frequency switching mode

Linear or logarithmic frequency switching can be selected. The selected setting is valid for all scan ranges.

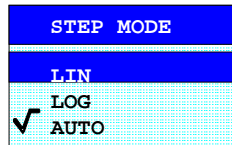

LIN linear frequency switching.

AUTO linear frequency switching.
The step width is selected automatically depending on the set resolution bandwidth so that all signals occurring in the scan range are reliably detected without any significant measurement error (about one third of resolution bandwidth)

LOG logarithmic frequency switching.
The frequency is incremented in % of the current frequency..

IEC/IEEE-bus command `SWE:SPAC LIN`

Start - Entry of start frequency

The start frequency of a subrange must be equal to or greater than the stop frequency of the previous subrange.

On entering the start frequency, the preceding scan range is – if necessary – adapted automatically to avoid overlapping of scan ranges.

IEC/IEEE-bus command `SCAN1:STAR 150 kHz`

Stop - Entry of stop frequency

The stop frequency of a subrange must be equal to or greater than the start frequency of the subrange.

On entering the stop frequency, the preceding scan range is – if necessary – adapted automatically to avoid overlapping of scan ranges.

IEC/IEEE-bus command `SCAN1:STOP 30 MHz`

Step Size - Entry of step size

In the case of linear frequency increments, step widths between 1 Hz and the maximum R&S ESCI frequency can be set. When a step size greater than the scan range is entered (from start to stop), R&S ESCI performs a measurement at the start and stop frequency.

With logarithmic frequency increments, values between 0.1% and 100% can be set with steps of 1/2/3/5.

With *STEP AUTO* selected, the step size cannot be changed because it is automatically set with respect to the IF bandwidth.

IEC/IEEE-bus command `SCAN1:STEP 4 kHz`

RES BW - Entry of IF bandwidth

In the case of quasi-peak weighting, usually a fixed bandwidth is set which cannot be changed (CISPR).

However, the coupling of the IF bandwidth to the frequency range can be cancelled using softkey *QP RBW UNCOUPLED* in the *MEAS DETECTOR* menu.

IEC/IEEE-bus command `SCAN1:BAND:RES 9 kHz`

Meas Time - Entry of measurement time

The measurement time can be set between 100 μ s and 100 s separately for each subrange. In the case of quasi-peak weighting, the minimum is 1 ms. The measurement time can be set independently for each scan range.

IEC/IEEE-bus command `SCAN1:TIME 1ms`

Auto Ranging - Activates the autorange function

ON R&S ESCI automatically sets the input attenuation as a function of the signal level.

Caution:

If 0 dB RF attenuation is used with autoranging, care must be taken that the permissible signal level at the RF input is not exceeded.

Exceeding this level would damage the input mixer.

The 0 dB attenuation should under no circumstances be used when RFI voltage measurements are performed with the aid of artificial networks as in this case very high pulses occur during phase switching.

OFF The input attenuation setting of the scan table is used.

IEC/IEEE-bus command `SCAN1:INP:ATT:AUTO OFF`

RF Atten - Entry of a fixed RF attenuation

The RF attenuation can be set separately for each subrange

IEC/IEEE-bus command `SCAN1:INP:ATT:AUTO OFF`

Preamp - Switching the preamplifier on and off

The preamplifier can be switched on/off separately for each subrange

IEC/IEEE-bus command `SCAN1:INP:GAIN:STAT OFF`

Auto Preamp - Activates the auto preamp function

ON The preamplifier is considered in autoranging. It is only cut in after the attenuation has been reduced to the minimum settable value.

ON Auto ranging without preamplification

IEC/IEEE-bus command `SCAN1:INP:GAIN:AUTO OFF`

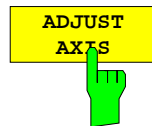

The *ADJUST AXIS* softkey automatically sets the limits of the diagram so that the lower limit frequency corresponds to the start frequency of range 1 and the upper limit frequency to the stop frequency of the last range.

IEC/IEEE-bus command --



The *INS BEFORE RANGE* softkey shifts the active scan range in the table to the left by one column. A new column with identical settings is created. The limit frequencies can be changed accordingly.

IEC/IEEE-bus command --



The *INS AFTER RANGE* softkey shifts the active scan range in the table to the right by one column. A new column with identical settings is created. The limit frequencies can be changed accordingly.

IEC/IEEE-bus command --

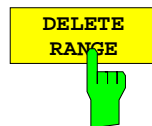

The *DELETE RANGE* softkey clears the activated scan range. All other ranges are shifted to the left by one column.

IEC/IEEE-bus command --

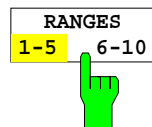

With the *RANGES 1-5/6-10* softkey a switchover can be made between ranges 1-5 and 6-10.

IEC/IEEE-bus command --

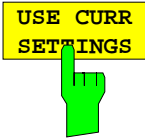

The *USE CURR SETTINGS* softkey activates a scan which is performed using the current receiver settings. The step size is automatically set with respect to the IF bandwidth (Step Mode Auto). The start and stop frequency is set via the *FREQ* menu.

IEC/IEEE-bus command --

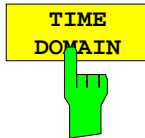

The *TIME DOMAIN* softkey activates time domain analysis.

The overall measurement time for time domain analysis can be defined in a data entry field. The range is 100 μ s to 10.000 s. The value entered is rounded to next integer that is a multiple of the measurement time of a single bargraph measurement. The minimum value also depends on the set measurement time of a single bargraph measurement and is at least twice this value.

IEC/IEEE-bus command `FREQuency:MODE CW`
`SCAN:TDOMain 100 s`

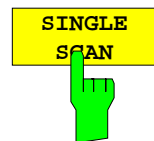

Pressing the *SINGLE SCAN* softkey triggers a frequency scan. R&S ESCI stops at the end frequency.

The enhancement label *SGL* displayed at the screen edge indicates that the single-scan mode is set.

IEC/IEEE-bus command `:INIT2:CONT OFF`

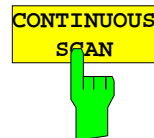

The *CONTINUOUS SCAN* softkey selects the continuous scan mode. R&S ESCI scans continuously until the scan is stopped.

IEC/IEEE-bus command `:INIT2:CONT ON`



The *FREQ AXIS LIN/LOG* switches between linear and logarithmic frequency axis.

Default is *LOG*.

IEC/IEEE-bus command `DISP:TRAC:X:SPAC LOG`

Running a Scan

CONFIGURATION MODE - RECEIVER menu

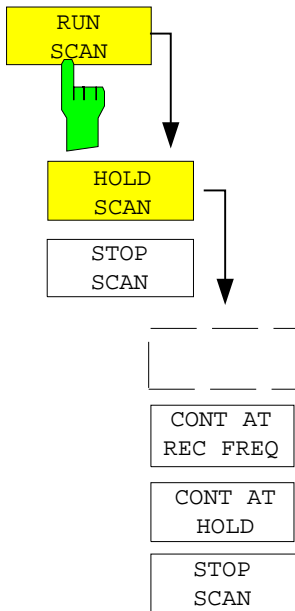

The *RUN SCAN* softkey starts the frequency scan with the selected settings. The *HOLD SCAN* submenu is displayed instead of the menu shown before the scan is started.

At the beginning of the scan, R&S ESCI sets up the diagram as specified in the scan table and starts the scan in the selected mode (*SINGLE* or *CONTINUOUS*). With *SINGLE* selected, R&S ESCI performs a single scan and stops at the end frequency. With *CONTINUOUS* selected, the scan is performed continuously until it is deliberately stopped.

The measurement can be interrupted with *HOLD SCAN* or stopped with *STOP SCAN*. The two softkeys are displayed instead of the menu shown before the scan is started.

If a transducer set is defined with points of changeover, the scan automatically stops at the frequencies of the new subrange of the transducer set and the user may exchange the transducer.

The following message informs the user that the limit has been reached:

TDS Range # reached, CONTINUE / BREAK

He can continue the scan at the point of change over by confirming the message (*CONTINUE*) or he can switch off the transducer (*BREAK*).

IEC/IEEE-bus command `INITiate2`

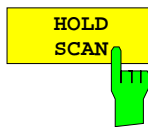

The *HOLD SCAN* softkey interrupts the scan.

The scan stops at the frequency at which it was interrupted until it is continued with the *CONT AT REC FREQ* or *CONTINUE AT HOLD* softkeys.

While the scan is stopped, the receiver settings can be changed, e.g. for a detailed analysis of the recorded trace.

IEC/IEEE-bus command `:HOLD`

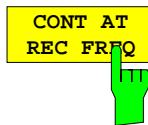

With the *CONT AT REC FREQ* softkey the scan is continued at the current receiver frequency when the receiver frequency is lower than the frequency at which the scan was interrupted.

Otherwise the scan continues at the frequency at which it was interrupted.

The scan is always continued with the settings in the scan table.

IEC/IEEE-bus command `:INITiate2:CONMeasure`

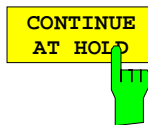

With the *CONT AT HOLD* softkey the scan is continued where it was interrupted. The scan is always continued with the settings in the scan table.

IEC/IEEE-bus command `--`

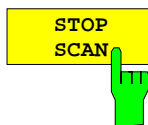

The *STOP SCAN* softkey stops the scan. Upon restart, scanning starts at the beginning. The results of the performed measurements are lost.

IEC/IEEE-bus command `:ABORt`

Triggering the Scan– TRIG Key

The *TRIG* key opens a menu for selection of the trigger sources and the trigger polarity. The active trigger mode is indicated by highlighting the corresponding softkey.

To indicate that a trigger mode other than *FREE RUN* has been set, the enhancement label **TRG** is displayed on the screen. If two windows are displayed, TRG appears next to the appropriate window.

TRIGGER menu

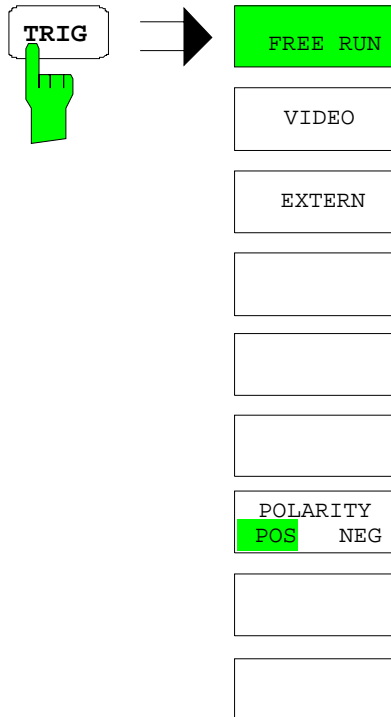

The *FREE RUN* softkey activates the free-run sweep mode, i.e. start of a scan is not triggered. Once a measurement is completed, another is started immediately.

FREE RUN is the default setting of R&S ESCI.

IEC/IEEE-bus command: TRIG:SOUR IMM

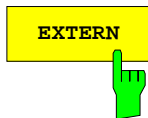

The *VIDEO* softkey activates triggering via the displayed voltage. For the video triggering mode, a level line showing the trigger threshold is displayed. Using the level line, the threshold can be adjusted between 0 % ...100 % of the diagram height.

IEC/IEEE-bus command: TRIG:SOUR EXT
SWE:EGAT:SOUR EXT

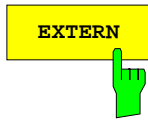

The *EXTERN* softkey activates triggering via a TTL signal at the input connector *EXT TRIGGER/GATE* on the rear panel.

IEC/IEEE-bus command: TRIG:SOUR EXT
 SWE:EGAT:SOUR EXT

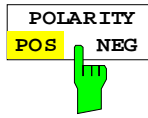

The *POLARITY POS/NEG* softkey selects the polarity of the trigger source.

The scan starts after a positive or negative edge of the trigger signal. The selected setting is highlighted.

The selection is valid for all trigger modes with the exception of *FREE RUN*.

The default setting is *POLARITY POS*.

IEC/IEEE-bus command: TRIG:SLOP POS

Marker Functions – MKR Key

MKR menu:

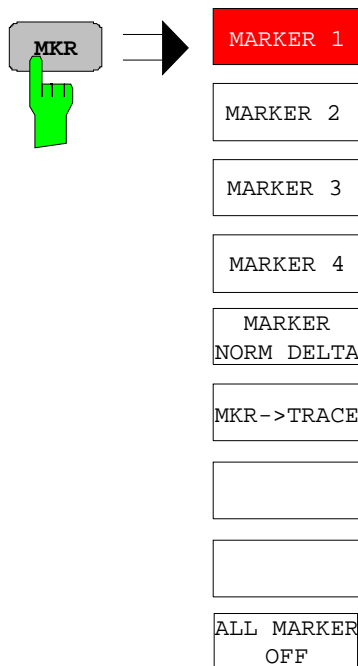

The *MARKER 1/2/3/4* softkey selects the corresponding marker and activates it.

MARKER 1 is always the normal marker. After they have been switched on, *MARKERS 2 to 4* are delta markers that refer to *MARKER 1*. These markers can be converted into markers with absolute value display by means of the *MARKER NORM DELTA* softkey. When *MARKER 1* is the active marker, pressing the *MARKER NORM DELTA* softkey switches on an additional delta marker.

Pressing the *MARKER 1 to 4* softkey again switches off the selected marker.

IEC/IEEE bus commands

```
:CALC:MARK ON;
:CALC:MARK:X 10.7MHz;
:CALC:MARK:Y?
```

When several traces are being displayed, the marker is set to the maximum value (peak) of the active trace which has the lowest number (1 to 3). In case a marker is already located there, it will be set to the frequency of the next lowest level (next peak).

A marker can only be enabled when at least one trace in the corresponding window is visible.

If a trace is turned off, the corresponding markers and marker functions are also deactivated. If the trace is switched on again (*VIEW, CLR/WRITE;..*), the markers along with coupled functions will be restored to their original positions provided the markers have not been used on another trace.

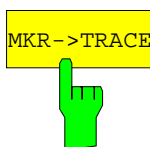

The *MKR→TRACE* softkey places the marker on a new trace. The trace is selected via a data entry field. Only those traces can be selected which are visible on the screen in the same window.

Example:

Three traces are presented on the screen. The marker is always on Trace 1 on switching on.

```
[MKR ->TRACE]
"2"<ENTER>
```

The marker jumps to Trace 2 but remains on the previous frequency or time.

```
[MKR ->TRACE]
"3"<ENTER>
```

The marker jumps to Trace 3.

IEC/IEEE-bus command: `CALC:MARK1:TRAC 1`
`CALC:DELT:TRAC 1`

Change of Settings via Markers – MKR ⇒ Key

The MKR → menu offers functions through which instrument parameters can be changed with the aid of the currently active marker. The functions can be used on markers and delta markers.

On opening the menu, the entry for the last active marker is activated; if no marker was enabled, MARKER 1 is activated and a peak search is performed.

MKR → menu

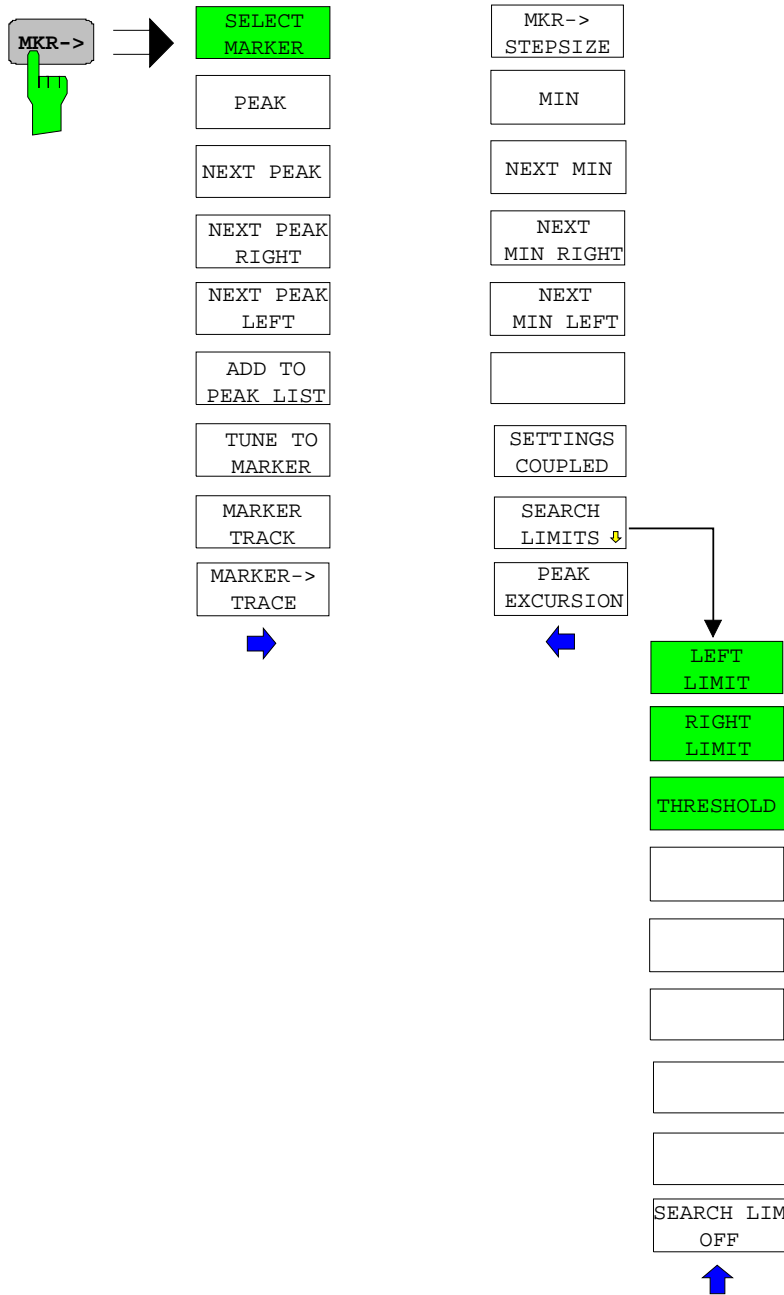



The *SELECT MARKER* softkey activates the numerical selection of the marker in the data entry field. If no marker is active when **MKR->** menu is called, *MARKER 1* is automatically switched on. Delta marker 1 is selected by input of '0'.

IEC/IEEE-bus command: `CALC:MARK1 ON;`
 `CALC:MARK1:X <value>;`
 `CALC:MARK1:Y?`

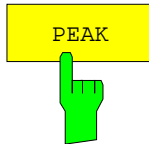

The *PEAK* softkey sets the active marker or delta marker to the peak of the trace.

If no marker is active when **MKR->** menu is called, *MARKER 1* is automatically switched on and the peak search is performed.

IEC/IEEE-bus command: `CALC:MARK:MAX`
 `CALC:DELT:MAX`



The *NEXT PEAK* softkey sets the active marker/delta marker to the next lower peak value on the trace. The search direction is defined in the *NEXT MODE* submenu (see analyzer mode).

IEC/IEEE-bus command: `CALC:MARK:MAX:NEXT`
 `CALC:DELT:MAX:NEXT`

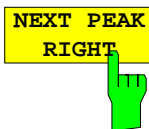

The *NEXT PEAK RIGHT* softkey sets the active marker/delta marker to the next lower peak value to the right on the trace.

IEC/IEEE bus commands: `CALC:MARK:MAX:RIGH`
 `CALC:DELT:MAX:RIGH`

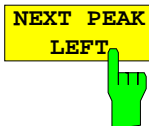

The *NEXT PEAK LEFT* softkey sets the active marker/delta marker to the next lower peak value to the left on the trace.

d
 IEC/IEEE bus commands: `CALC:MARK:MAX:LEFT`
 `CALC:DELT:MAX:LEFT`



The *ADD TO PEAK LIST* softkey adds the receiver frequency of the current marker to the peak list (see also Section "Data Reduction and Peak List").

IEC/IEEE bus command --



The *TUNE TO MARKER* softkey sets the receiver frequency to the marker frequency.

IEC/IEEE bus command : `CALC:MARK:FUNC:CENT`



The *MARKER TRACK* softkey couples the current receive frequency to the marker frequency.

IEC/IEEE bus command : `CALC:MARK:COUP ON`

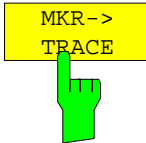

The *MKR*→*TRACE* softkey sets the active marker to a new trace. Please note that only a trace visible in the measurement window can be selected.

This softkey is also available in the *MKR* menu.

IEC/IEEE-bus command: `CALC:MARK:TRAC 2`

Example:

Three traces are displayed on the screen. The marker is always on Trace 1 after switching on.

[*MKR* ->*TRACE*] "2" <ENTER> The marker jumps to Trace 2 but remains at the previous frequency or time.

[*MKR* ->*TRACE*] "3" <ENTER> The marker jumps to Trace 3.



The *MKR*→*CF STEPSIZE* softkey sets the step size for the receiver frequency variation to the current marker frequency, and also sets step size adaptation to *MANUAL*. *STEPSIZE* remains at this value until the receiver frequency entry mode in the *STEP* menu is switched from *MANUAL* to *AUTO* again.

The *MKR*→*CF STEPSIZE* function is, above all, useful in the measurement of harmonics.

IEC/IEEE-bus command: `CALC:MARK:FUNC:CST`

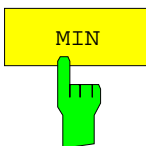

The *MIN* softkey sets the active marker to the minimum value on the corresponding trace.

IEC/IEEE-bus command: `CALC:MARK:MIN`
`CALC:DELT:MIN`

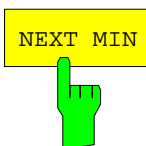

The *NEXT MIN* softkey sets the active marker to the next higher minimum value on the corresponding trace. The search direction is defined in the *NEXT MODE* submenu (see below).

IEC/IEEE-bus command: `CALC:MARK:MIN:NEXT`
`CALC:DELT:MIN:NEXT`



The *NEXT MIN LEFT* softkey sets the active marker to the next higher minimum value to the left on the corresponding trace.

IEC/IEEE-bus command: `CALC:MARK:MIN:LEFT`
`CALC:DELT:MIN:LEFT`

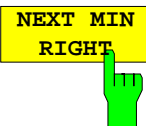

The *NEXT MIN RIGHT* softkey sets the active marker to the next higher minimum value to the right on the corresponding trace.

IEC/IEEE-bus command: `CALC:MARK:MIN:RIGH`
`CALC:DELT:MIN:RIGH`

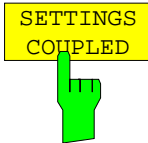

The *SETTINGS COUPLED* softkey couples the receiver frequency settings from the corresponding subscans to the marker frequency for functions *TUNE TO MARKER* and *MARKER TRACK*.

IEC/IEEE bus command :CALC:MARK:SCO ON

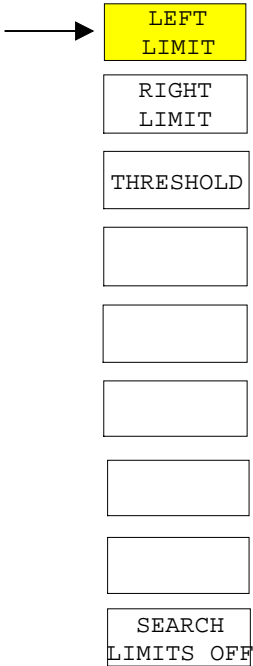

The *SEARCH LIMITS* softkey limits the search range for maximum or minimum search. The softkey switches to a submenu in which the search range limits can be set in the x and y direction.

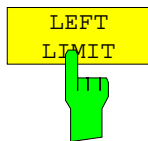

The *LEFT LIMIT* and *RIGHT LIMIT* softkeys define the two vertical lines SL1 and SL2. The search is performed between these lines in the frequency and time domain. If only one line is enabled, line SL1 is the lower limit and the upper limit corresponds to the stop frequency. If SL2 is also enabled, it determines the upper limit.

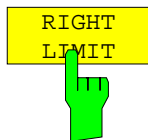

IEC/IEEE-bus command: CALC:MARK:X:SLIM:LEFT 1MHZ
CALC:MARK:X:SLIM:RIGH 10MHZ
CALC:MARK:X:SLIM ON

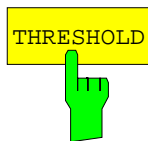

The *THRESHOLD* softkey defines the threshold line. The threshold line represents a limit for the level range of the max. search at the lower end and that of the min. search at the upper end.

IEC/IEEE-bus command: CALC:THR -20dBm
CALC:THR ON



SEARCH
LIMIT OFF

The *SEARCH LIMIT OFF* softkey disables all limits of the search range.

IEC/IEEE-bus command: `CALC:MARK:X:SLIM OFF`
`CALC:THR OFF`

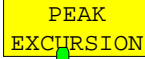

PEAK
EXCURSION

The *PEAK EXCURSION* softkey activates an entry box for selecting the minimum amount by which a signal level must decrease/increase before it is recognized by the *NEXT PEAK* and *NEXT MIN* search functions as a maximum or minimum.

Input values from 0 to 80 dB are allowed, the resolution being 0.1 dB.

IEC/IEEE-bus command: `CALC:MARK:PEXC 10dB`

For detailed explanation see softkey *PEAK EXCURSION* in *ANALYZER* mode

Marker Functions – MKR FCTN Key

MKR FCNT Menu:

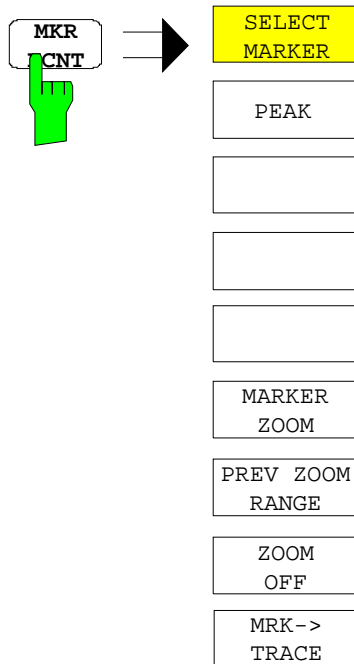

On calling the menu, the entry for the last active marker is activated (*SELECT MARKER* softkey); if no marker is activated, marker 1 is activated and a maximum search (*PEAK* softkey) is performed. The marker can be set to the desired trace by means of *MKR -> TRACE* softkey.



The *MARKER ZOOM* softkey zooms 10% of the diagram around the current marker. It opens at the same time a data entry field which allows to enter any frequency range which is then displayed. Pressing the softkey again expands the diagram such that only 3 measured values are represented.

IEC/IEEE bus command : CALC:MARK:FUNC:ZOOM <num_value>

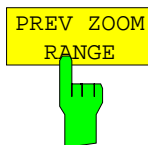

The *PREVIOUS ZOOM* softkey sets again the previous frequency range

IEC/IEEE bus command --

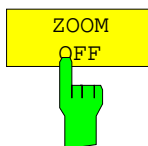

The *ZOOM OFF* softkey switches off the zoomed representation.

IEC/IEEE bus command : DISP:TRAC:X:ZOOM OFF

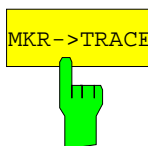

The *MKR->TRACE* softkey places the marker on a new trace. The trace is selected via a data entry field. Only those traces can be selected which are visible on the screen in the same window.

IEC/IEEE-bus command: CALC:MARK1:TRAC 1
CALC:DELT:TRAC 1

Selection and Setting of Traces –TRACE Key

The R&S ESCI is capable of displaying up to three different traces at a time in a diagram. A trace consists of a maximum of 501 pixels on the horizontal axis (frequency or time). If more measured values than pixels are available, several measured values are combined in one pixel.

The traces are selected using the *SELECT TRACE* softkey in the menu of the *TRACE* key.

The traces can individually be activated for a measurement or frozen after completion of a measurement. Traces that are not activated are blanked.

The display mode can be selected for each trace. Traces can be overwritten in each measurement (CLEAR/WRITE mode), averaged over several measurements (AVERAGE mode), or a maximum or minimum value can be determined from several measurements and displayed (MAX HOLD or MIN HOLD).

Individual detectors can be selected for the various traces. The max peak detector and min peak detector display the maximum and minimum value of the level within a pixel. The rms detector displays the power (rms value) of the measured values within a pixel, the average detector the average value.

The quasi-peak detector yields the level weighted to CISPR 16.

Selection of Trace Function

The trace functions are subdivided as follows:

- Display mode of trace (CLEAR/WRITE, VIEW and BLANK)
- Evaluation of the trace as a whole (AVERAGE, MAX HOLD and MIN HOLD)
- Evaluation of individual pixels of a trace (MAX PEAK, MIN PEAK, QUASIPEAK, AVERAGE and RMS).

TRACE menu

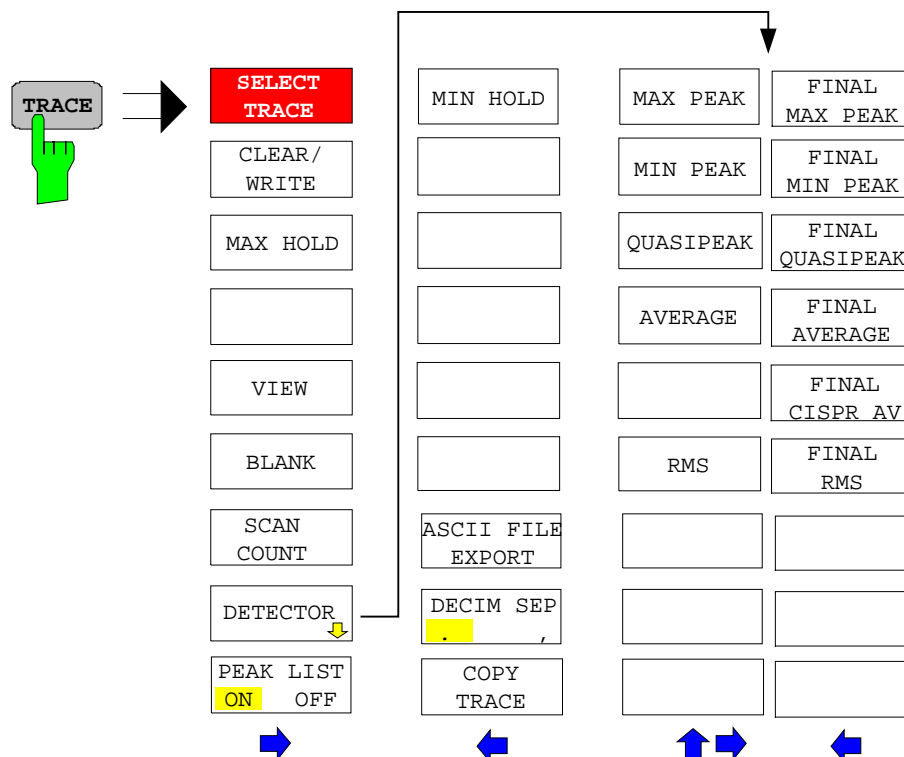

The *TRACE* key opens a menu offering the setting options for the selected trace.

In this menu, the mode of representing the measured data in the frequency or time domain in the 501 pixels of the display is determined. Upon start of the measurement, each trace can be displayed either completely new or based on the previous results.

Traces can be displayed, blanked and copied.

The measurement detector for the individual display modes can be selected directly by the user.

The default setting is trace 1 in the overwrite mode (*CLEAR / WRITE*) and detector *MAX PEAK* is selected, trace 2 is also in the overwrite mode (*CLEAR / WRITE*) and detector *AVERAGE* is selected, trace 3 is switched off (*BLANK*).

The *CLEAR/WRITE*, *MAX HOLD*, *MIN HOLD*, *AVERAGE*, *VIEW* and *BLANK* softkeys are mutually exclusive selection keys.

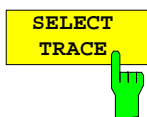

The *SELECT TRACE* softkey activates the entry for the active trace (1, 2, 3).

IEC/IEEE-bus command -- (selected via numeric suffix of :TRACe)

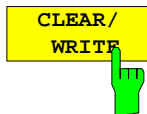

The *CLEAR/WRITE* softkey activates the overwrite mode for the collected measured values, i.e. the trace is overwritten by each sweep.

Each time the *CLEAR/WRITE* softkey is actuated, R&S ESCI clears the selected trace memory and starts the measurement anew.

IEC/IEEE-bus command `DISP:WIND:TRAC:MODE WRIT`

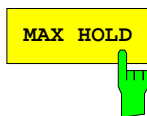

The *MAX HOLD* softkey activates the max peak detector.

R&S ESCI saves the sweep result in the trace memory only if the new value is greater than the previous one.

This is especially useful with modulated or impulsive signals. The signal spectrum is filled up upon each scan until all signal components are detected in a kind of envelope.

Pressing the *MAX HOLD* softkey again clears the trace memory and restarts the max hold mode.

IEC/IEEE-bus command `DISP:WIND:TRAC:MODE MAXH`

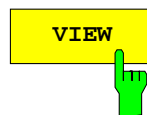

The *VIEW* softkey freezes the current contents of the trace memory and displays it.

If in the *VIEW* display mode the level display range (*GRID RANGE*) or the reference level (*GRID MIN LEVEL*) are changed, R&S ESCI automatically adapts the measured data to the changed display range. This allows an amplitude zoom to be made after the measurement in order to show details of the trace.

IEC/IEEE-bus command `DISP:WIND:TRAC:MODE VIEW`

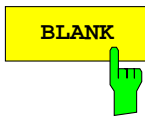

The *BLANK* softkey activates the blanking of the trace on the screen.

IEC/IEEE-bus command `DISP:WIND:TRAC OFF`

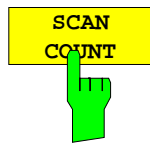

The *SCAN COUNT* softkey activates the entry of the number of scan used in the *SINGLE SCAN* mode.

The allowed range of values is 0 to 30000. The default setting is 1.

IEC/IEEE-bus command `SWE:COUN 10`

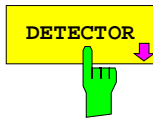

The *DETECTOR* softkey opens a submenu to select the detector.

The detector type may be indecently selected for each trace.

For description of detector types see Section "Detector Selection" in Analyzer Mode.

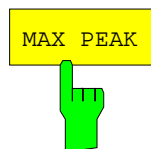

The *MAX PEAK* softkey activates the max peak detector.

IEC/IEEE bus command `DET POS`

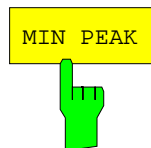

The *MIN PEAK* softkey activates the min peak detector.

IEC/IEEE bus command `DET NEG`

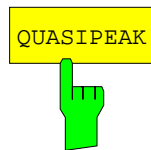

The *QUASIPeAK* softkey selects the quasi-peak detector.

The IF bandwidth is adapted as a function of the frequency range. The coupling of the IF bandwidth to the frequency range can be cancelled using softkey *QP RBW UNCOUPLED*.

IEC/IEEE-bus command `DET QPE`

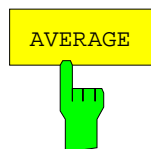

The *AVERAGE* softkey activates the average detector.

IEC/IEEE bus command `DET AVER`

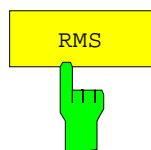

The *RMS* softkey activates the rms detector.

IEC/IEEE bus command `:DET RMS`

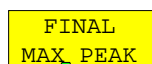

FINAL
MAX PEAK

The *FINAL MAX PEAK* selects the max peak detector for the final measurement.

IEC\IEEE bus command :DET:FME POS

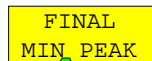

FINAL
MIN PEAK

The *FINAL MIN PEAK* selects the min peak detector for the final measurement.

IEC\IEEE bus command :DET:FME NEG

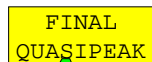

FINAL
QUASIPeAK

The *FINAL QUASIPeAK* selects the quasi peak detector for the final measurement.

IEC\IEEE bus command :DET:FME QPE

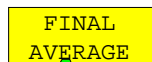

FINAL
AVERAGE

The *FINAL AVERAGE* selects the average detector for the final measurement.

IEC\IEEE bus command :DET:FME AVER

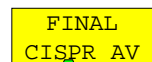

FINAL
CISPR AV

The *FINAL CISPR AV* selects the weighting average detector according to CISPR 16-1 for the final measurement.

IEC\IEEE bus command :DET:FME CAV



FINAL
RMS

The *FINAL RMS* selects the rms detector for the final measurement.

IEC\IEEE bus command :DET:FME RMS

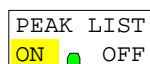

PEAK LIST
ON OFF

The *PEAK LIST ON / OFF* softkey switches on and off the indication of the peak list or of the final measurement results. The single value is indicated as + or x. The assignment of symbol to trace is fixed.

RUN SCAN automatically switches *PEAK LIST* to *OFF* in order to prevent the indication of preceding final measurement results. *PEAK SEARCH* automatically sets *PEAK LIST* to *ON* (see Data Reduction and Peak List)

IEC\IEEE bus command DISP:TRAC:SYMB CROS | OFF

TRACE side menu:

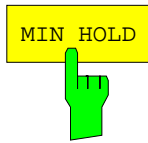

The *MIN HOLD* softkey activates the min peak detector. R&S ESCI saves for each scan the smallest of the previously stored/currently measured values in the trace memory.

This function is useful e.g. for making an unmodulated carrier in a composite signal visible. Noise, interference signals or modulated signals are suppressed by the min hold function whereas a CW signal is recognized by its constant level.

Pressing the *MIN HOLD* softkey again clears the trace memory and restarts the min hold function.

IEC/IEEE-bus command DISP:WIND:TRAC:MODE MINH



The *ASCII FILE EXPORT* softkey stores the active trace in ASCII format on a floppy disk.

IEC/IEEE command FORM ASC;
MMEM:STOR:TRAC 1, 'TRACE.DAT'

The file consists of the header containing important scaling parameters, several data sections containing the scan settings and a data section containing the trace data.

The data of the file header consist of three columns, each separated by a semicolon:
parameter name; numeric value; basic unit

The data section for the scan ranges starts with the keyword "Scan <n>:", (<n> = number of scan range), followed by the scan data in one or several columns which are also separated by a semicolon.

The data section for the trace data starts with the keyword " Trace <n> " (<n> = number of stored trace), followed by the measured data in one or several columns which are also separated by a semicolon.

This format can be read in from spreadsheet calculation programs, e.g. MS-Excel. It is necessary to define ';' as a separator.

Note: *Different language versions of evaluation programs may require a different handling of the decimal point. It is therefore possible to select between separators '.' (decimal point) and ',' (comma) using softkey DECIM SEP.*

Example:

	File contents	Description
File header	Type;R&S ESCI Version;1.00; Date;10.Nov 03; Mode;Receiver; Start;150000.000000;Hz Stop;1000000000.000000;Hz x-Axis;LOG; Detector;AVERAGE; Scan Count;1; Transducer;;	Instrument model Firmware version Date of data set storage Instrument mode Start/stop of the display range. Unit: Hz Scaling of x-axis linear (LIN) or logarithmic (LOG) Selected detector MAXPEAK, MINPEAK, AVERAGE, RMS, QUASIPeAK Scan count Transducer name (if switched on)
Data section of the file Scan ranges	Scan 1: Start;150000.000000;Hz Stop;30000000.000000;Hz Step; 4000.000000;Hz RBW;9000.000000;Hz Meas Time;0.001000;s Auto Ranging;OFF; RF Att;10.000000;dB Auto Preamp;OFF; Preamp;0.000000;dB Scan 2: Start;30000000.000000;Hz Stop;1000000000.000000;Hz Step; 50000.000000;Hz RBW;120000.000000;Hz Meas Time;0.000100;s Auto Ranging;OFF; RF Att;10.000000;dB Auto Preamp;OFF; Preamp;0.000000;dB	Settings for scan range 1 Range 1 - start frequency in Hz Range 1 – stop frequency in Hz Range 1 - step width Range 1 - resolution bandwidth Range 1 - measurement time Range 1 - Auto ranging on - or off Range 1 - input attenuation Range 1 - Auto Preamp on or off Range 1 - preamplifier on (20dB) or off (0dB) Settings for scan range 2 Range 2 - start frequency in Hz Range 2 – stop frequency in Hz Range 2 - step width Range 2 - resolution bandwidth Range 2 - measurement time Range 2 - Auto ranging on - or off Range 2 - input attenuation Range 2 - Auto Preamp on or off Range 2 - preamplifier on (20dB) or off (0dB)
Data section of the file trace	Trace 1: Trace Mode;CLR/WRITE; x-Unit;Hz; y-Unit;d μ V; Values;26863; 150000.000000;15.604355; 154000.000000;13.236252; 158000.000000;11.907021; ...;...	Selected trace Trace mode: CLR/WRITE, MAXHOLD Unit of x values: Hz for span > 0 Unit of y values: dB*/V/A/W depending on the selected unit Number of test points Measured values: <x value>, <y value>;

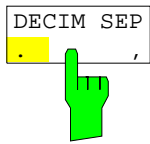

The *DECIM SEP* softkey selects the decimal separator between '.' (decimal point) and ',' (comma) with floating-point numerals for the function ASCII FILE EXPORT.

With the selection of the decimal separator different language versions of evaluation programs (e.g. MS-Excel) can be supported.

IEC/IEEE-bus command `FORM:DEXP:DSEP POIN`

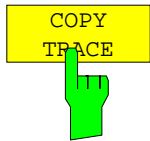

The *COPY TRACE* softkey copies the screen contents of the current trace into another trace memory. The desired memory is selected by entering the number 1, 2 or 3.

Upon copying, the contents of the selected memory is overwritten and the new contents displayed in view mode.

IEC/IEEE-bus command `TRAC:COPY TRACE1,TRACE2`

Spectrum Analyzer Mode

The analyzer mode is activated by pressing hotkey *SPECTRUM* (see also Section 'Mode Selection')

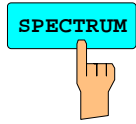

The *SPECTRUM* hotkey selects the *ANALYZER* mode.

This mode is the default setting of the R&S ESCI.

The functions provided correspond to those of a conventional spectrum analyzer. The analyzer measures the frequency spectrum of the test signal over the selected frequency range with the selected resolution and sweep time, or, for a fixed frequency, displays the waveform of the video signal.

Note: If two displays (screen A and screen B) are opened after switch-on of signal analysis, the analyzer mode is only set for the display activated for entry (marked at the top right corner of diagram). For the other display, the previous settings remain valid.
Data acquisition and display of measured values is sequential: first in the upper and then in the lower display.

Frequency and Span Selection – *FREQ* Key

After pressing one of the *CENTER*, *START* or *STOP* softkeys, the value of the corresponding parameter can be defined in an input window.

FREQ menu:

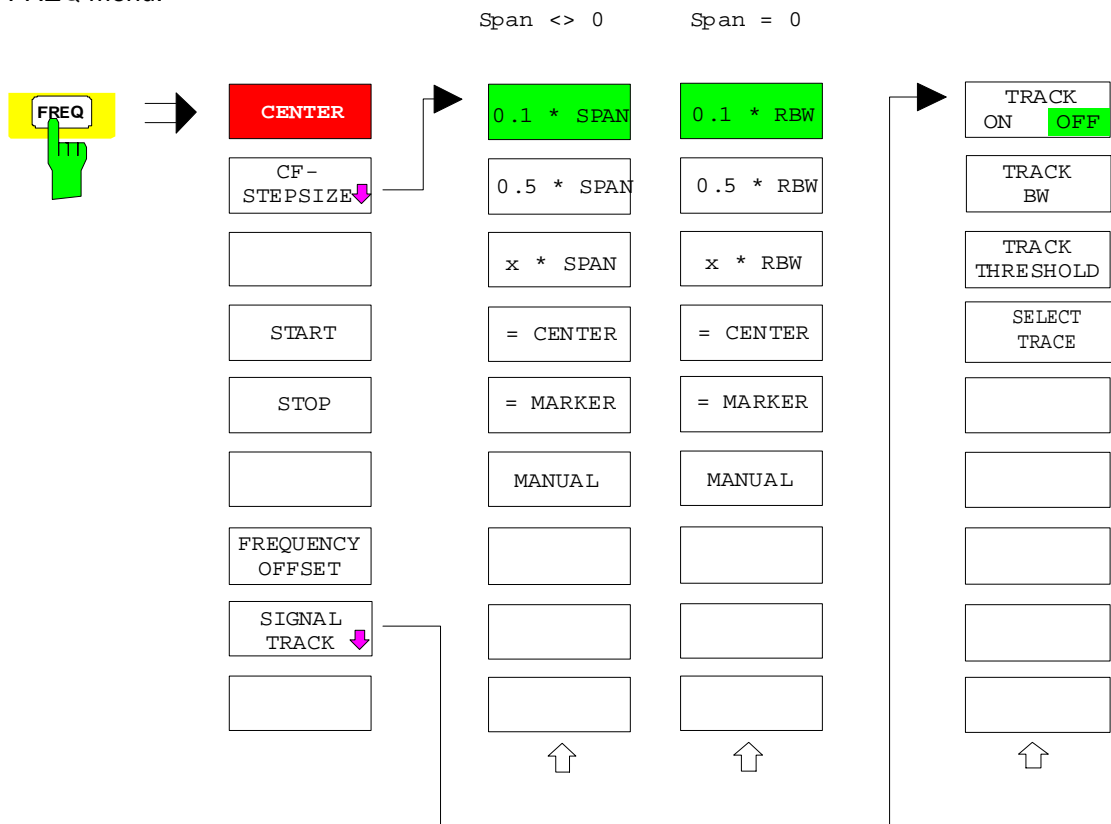



The *CENTER* softkey opens the window for manually entering the center frequency.

The allowed range of values for the center frequency is:

for the frequency domain (span >0):

$$\text{minspan} / 2 \leq f_{\text{center}} \leq f_{\text{max}} - \text{minspan} / 2$$

and for the time domain (span = 0):

$$0 \text{ Hz} \leq f_{\text{center}} \leq f_{\text{max}}$$

f_{center} center frequency
 minspan smallest selectable span > 0 Hz (10 Hz)
 f_{max} max. frequency

IEC/IEEE-bus command: `FREQ:CENT 100MHZ`



The *CF STEPSIZE* softkey opens a submenu for setting the step size of the center frequency. The step size can be coupled to the span (frequency domain) or the resolution bandwidth (time domain) or it can be manually set to a fixed value. The softkeys are mutually exclusive selection keys.

The softkeys are presented according to the selected domain (frequency or time).

Softkeys in frequency domain:

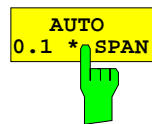

The *0.1 * SPAN* softkey sets the step size for the center frequency entry to 10% of the span.

IEC/IEEE-bus command: `FREQ:CENT:STEP:LINK SPAN`
`FREQ:CENT:STEP:LINK:FACT 10PCT`

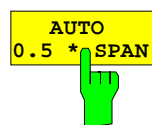

The *0.5 * SPAN* softkey sets the step size for the center frequency entry to 50% of the span.

IEC/IEEE-bus command: `FREQ:CENT:STEP:LINK SPAN`
`FREQ:CENT:STEP:LINK:FACT 50PCT`

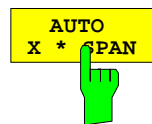

The *X * SPAN* softkey allows the factor defining the center frequency step size to be entered as % of the span.

IEC/IEEE-bus command: `FREQ:CENT:STEP:LINK SPAN`
`FREQ:CENT:STEP:LINK:FACT 20PCT`

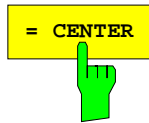

The = *CENTER* softkey sets the step size coupling to *MANUAL* and the step size to the value of the center frequency. This function is especially useful during measurements of the signal harmonic content because by entering the center frequency each stroke of the *STEP* key selects the center frequency of another harmonic.

IEC/IEEE-bus command: --



The = *MARKER* softkey sets the step size coupling to *MANUAL* and the step size to the value of the marker. This function is especially useful during measurements of the signal harmonic content at the marker position because by entering the center frequency each stroke of the *STEP* key selects the center frequency of another harmonic.

IEC/IEEE-bus command: --



The *MANUAL* softkey activates the window for entering a fixed step size.

IEC/IEEE-bus command: `FREQ:CENT:STEP 120MHz`

Softkeys in time domain:

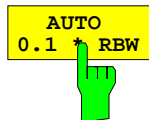

The *0.1 * RBW* softkey sets the step size for the center frequency entry to 10% of the resolution bandwidth.

*AUTO 0.1 * RBW* corresponds to the default setting.

IEC/IEEE-bus command: `FREQ:CENT:STEP:LINK RBW`

`FREQ:CENT:STEP:LINK:FACT 10PCT`

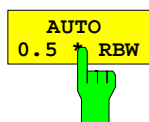

The *0.5 * RBW* softkey sets the step size for the center frequency entry to 50% of the resolution bandwidth.

IEC/IEEE-bus command: `FREQ:CENT:STEP:LINK RBW`

`FREQ:CENT:STEP:LINK:FACT 50PCT`

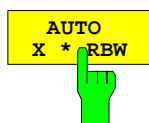

The *X * RBW* softkey allows the factor defining the center frequency step size to be entered as % of the resolution bandwidth.

Values between 1 and 100% in steps of 1% are allowed. The default setting is 10%.

IEC/IEEE-bus command: `FREQ:CENT:STEP:LINK RBW`

`FREQ:CENT:STEP:LINK:FACT 20PCT`

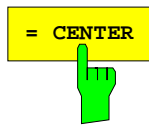

The = *CENTER* softkey sets the step size coupling to *MANUAL* and the step size to the value of the center frequency. This function is especially useful during measurements of the signal harmonic content because by entering the center frequency each stroke of the *STEP* key selects the center frequency of another harmonic.

IEC/IEEE-bus command: --



The = *MARKER* softkey sets the step size coupling to *MANUAL* and the step size to the value of the marker. This function is especially useful during measurements of the signal harmonic content at the marker position because by entering the center frequency each stroke of the *STEP* key selects the center frequency of another harmonic.

IEC/IEEE-bus command: --

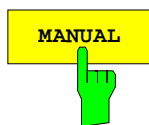

The *MANUAL* softkey activates the window for entering a fixed step size.

IEC/IEEE-bus command: `FREQ:CENT:STEP 120MHz`

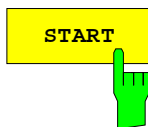

The *START* softkey activates the window for manually entering the start frequency.

The allowed range of values for the start frequency is:

$$0 \text{ Hz} \leq f_{\text{start}} \leq f_{\text{max}} - \text{minspan}$$

f_{start} start frequency
 minspan smallest selectable span (10 Hz)
 f_{max} max. frequency

IEC/IEEE-bus command: `FREQ:STAR 20MHz`

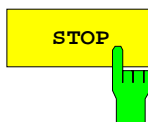

The *STOP* softkey activates the window for entering the .

The allowed range of values for the stop frequency is:

$$\text{minspan} \leq f_{\text{stop}} \leq f_{\text{max}}$$

f_{stop} stop frequency
 minspan smallest selectable span (10 Hz)
 f_{max} max. frequency

IEC/IEEE-bus command: `FREQ:STOP 2000MHz`

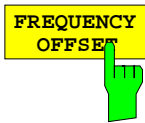

The *FREQUENCY OFFSET* softkey activates the window for entering an arithmetical frequency offset which is added to the frequency axis labelling. The allowed range of values for the offset is -100 GHz to 100 GHz. The default setting is 0 Hz.

IEC/IEEE-bus command: `FREQ:OFFS 10 MHz`



The *SIGNAL TRACK* softkey switches on the tracking of a signal near the center frequency. The signal is tracked as long it is in the search bandwidth around the center frequency defined with *TRACK BW* and above the level threshold defined with *TRACK THRESHOLD*.

For that purpose, the maximum signal is searched (*PEAK SEARCH*) on the screen and the center frequency set to this signal (*MARKER ->CENTER*) after each frequency sweep within the search bandwidth.

If the signal falls below the level threshold or jumps out of the search bandwidth around the center frequency, the center frequency is not varied until a signal is in the search bandwidth above the level threshold. This can be achieved by manually modifying the center frequency, for example.

On switching on, the softkey is highlighted and the search bandwidth and the threshold value are marked on the diagram by two vertical lines and one horizontal line. All these lines are allocated the designation TRK.

At the same time a submenu is opened in which the search bandwidth, the threshold value and the trace can be modified for the maximum search.

The softkey is only available in the frequency domain (span >0).

IEC/IEEE-bus command: `CALC:MARK:FUNC:STR OFF`

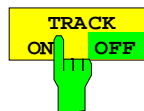

The *TRACK ON/OFF* softkey switches on and off signal tracking.

IEC/IEEE-bus command: `CALC:MARK:FUNC:STR OFF`

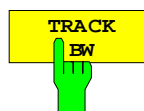

The *TRACK BW* softkey defines the search bandwidth for signal tracking. The frequency range is symmetrical with respect to the center frequency.

IEC/IEEE-bus command:

`CALC:MARK:FUNC:STR:BAND 10KHZ`



The *TRACK THRESHOLD* softkey defines the threshold value for signal detection. The value is always entered as an absolute level value.

IEC/IEEE-bus command:

`CALC:MARK:FUNC:STR:THR -70DBM`

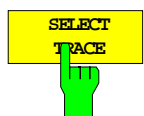

The *SELECT TRACE* softkey selects the trace on which signal tracking is to be performed.

IEC/IEEE-bus command:

`CALC:MARK:FUNC:STR:TRAC 1`

Setting the Frequency Span – SPAN Key

SPAN menu

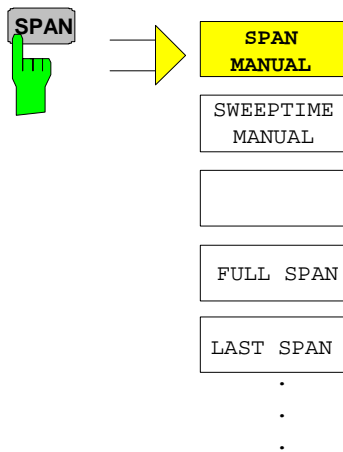

The *SPAN* key opens a menu which offers various options for setting the span.

The entry of the span (*SPAN MANUAL* softkey) is automatically active for span > 0 Hz.

For span = 0 Hz the entry for sweep time (*SWEEPTIME MANUAL*) is automatically active.

With two windows (*SPLIT SCREEN*) displayed at the same time, the input data always refer to the window selected with hotkey *SCREEN A/B*.

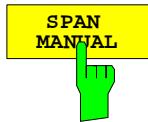

The *SPAN MANUAL* softkey activates the window for manually entering the frequency span. The center frequency is kept constant.

The allowed range of span values is for the time domain (span = 0): 0 Hz and for the frequency domain (span >0): $minspan \leq f_{span} \leq f_{max}$

f_{span}	frequency span
$minspan$	smallest selectable span (10 Hz)
f_{max}	max. frequency

IEC/IEEE-bus command `FREQ:SPAN 2GHz`

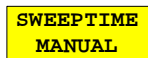

The *SWEEPTIME MANUAL* softkey activates the window for entering the sweep time manually with Span = 0 Hz. The softkey is not available for Span > 0 Hz.

IEC/IEEE-bus command: `SWE:TIME 10s`

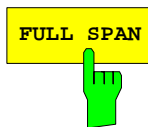

The *FULL SPAN* softkey sets the span to the full frequency range of R&S ESCI.

IEC/IEEE-bus command `FREQ:SPAN:FULL`

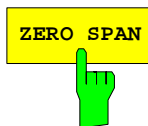

The *ZERO SPAN* softkey sets the span to 0 Hz. The x axis becomes the time axis with the grid lines corresponding to 1/10 of the current sweep time (SWT).

IEC/IEEE-bus command `FREQ:SPAN 0Hz`



After changing the span setting the *LAST SPAN* softkey activates the previous setting. With this function a fast change between overview measurement (*FULL SPAN*) and detailed measurement (manually set center frequency and span) is possible.

Note: Only values > 0 Hz are restored, i.e. a transition between time and frequency domain is not possible.

IEC/IEEE-bus command ---

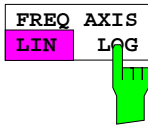

The *FREQ AXIS LIN/LOG* softkey switches between linear and logarithmic scaling of the frequency axis. Switchover is only possible if the stop/start frequency ratio is $\geq 1,4$.

IEC/IEEE-bus command SWE:SPAC LIN

Level Display Setting and RF Input Configuration – AMPT Key

The *AMPT* key is used to set the reference level, the maximum level and the display range of the active window as well as the input impedance and the input attenuation of the RF input.

The *AMPT* key opens a menu for setting the reference level and the input attenuation of the active window. The data entry for the reference level (*REF LEVEL* softkey) is opened automatically.

Further settings regarding level display and attenuation can be made in this menu.

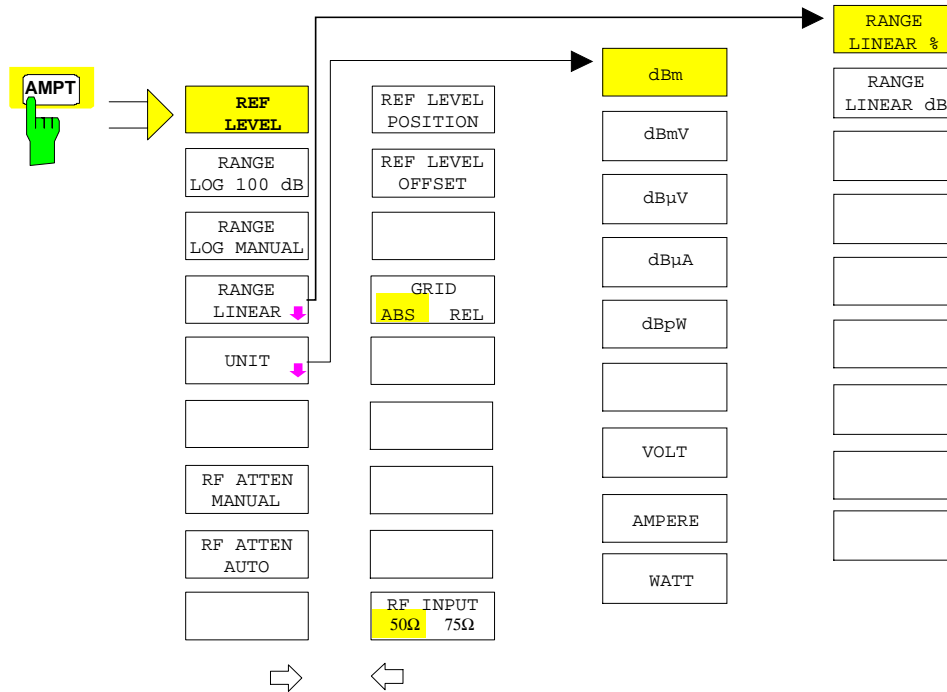

The *REF LEVEL* softkey allows the reference level to be input in the currently active unit (dBm, dBµV, etc).

IEC/IEEE-bus command: `DISP:WIND:TRAC:Y:RLEV -60dBm`

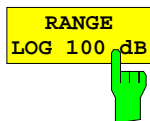

The *RANGE LOG 100 dB* softkey sets the level display range to 100 dB.

IEC/IEEE-bus command: `DISP:WIND:TRAC:Y:SPAC LOG`
`DISP:WIND:TRAC:Y 100DB`



The *RANGE LOG MANUAL* softkey activates the manual entry of the level display range. Display ranges from 10 to 200 dB are allowed in 10 dB steps. Inputs which are not allowed are rounded to the next valid value.

The default setting is 100 dB.

IEC/IEEE-bus command: `DISP:WIND:TRAC:Y:SPAC LOG`
 `DISP:WIND:TRAC:Y 120DB`

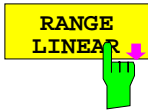

The *RANGE LINEAR* softkey selects linear scaling for the level display range of the analyzer. In addition, it opens a submenu for selecting % or dB for the scaling.

When linear scaling is selected, the % scaling is first activated (see also *RANGE LINEAR dB* softkey).

IEC/IEEE-bus command: `DISP:WIND:TRAC:Y:SPAC LIN`



The *RANGE LINEAR %* softkey selects linear scaling in % for the level display range, i.e. the horizontal lines are labelled in %. The grid is divided in decadic steps. Markers are displayed in the selected unit; delta markers are displayed in % referenced to the voltage value at the position of marker 1.

IEC/IEEE-bus command: `DISP:WIND:TRAC:Y:SPAC LIN`

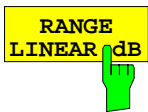

The *RANGE LINEAR dB* softkey selects linear scaling in dB for the level display range, i.e. the horizontal lines are labelled in dB. Markers are displayed in the selected unit; delta markers are displayed in dB referenced to the power value at the position of marker 1.

IEC/IEEE-bus command: `DISP:WIND:TRAC:Y:SPAC LDB`

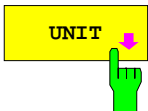

- dBm**
- dBmV
- dBμV
- dBμA
- dBpW
-
- VOLT
- AMPERE
- WATT

The *UNIT* softkey opens a sub menu allowing to select the unit for the level axis.

The default setting is dBm.

In general, the spectrum analyzer measures the signal voltage at the RF input. The level display is calibrated in rms values of an unmodulated sinewave signal. In the default state, the level is displayed at a power of 1 mW (= dBm). Via the known input resistance of 50 Ω or 75Ω , conversion to other units is possible. The units dBm, dBmV, dBμV, dBμA, dBpW, V, A and W are directly convertible.

IEC/IEEE-bus command: `CALC:UNIT:POW DBM`

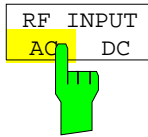

The *RF INPUT AC/DC* softkey switches between AC and DC coupling of the instrument input.

IEC/IEEE bus commands `INP:COUP AC`

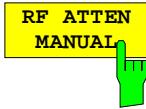

The *RF ATTEN MANUAL* softkey allows the attenuation to be entered irrespective of the reference level.

The attenuation can be set in 10 dB steps between 0 and 75 dB. Other entries will be rounded to the next lower integer value.

If the defined reference level cannot be set for the given RF attenuation, the reference level will be adjusted accordingly and the warning "Limit reached" will be output.

Note: *The value 0 dB cannot be switched on unless the 10 dB MIN function is off. This protects the input mixer from overloading by mistake.*

IEC/IEEE-bus command: `INP:ATT 40 DB`

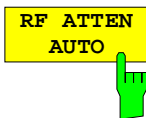

The *RF ATTEN AUTO* softkey sets the RF attenuation automatically as a function of the selected reference level.

This ensures that the optimum RF attenuation desired by the user is always used.

RF ATTEN AUTO is the default setting.

IEC/IEEE-bus command: `INP:ATT:AUTO ON`

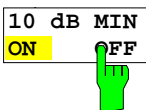

The *10 dB MIN* softkey determines whether or not the 0 dB position of the attenuator is used when the attenuation is set manually or automatically.

The default setting is "10 dB MIN ON".

This means the R&S ESCI always leaves at least 10 dB RF attenuation on in order to protect the input mixer.

The 0 dB position cannot be switched on manually by the user. This prevents 0 dB from being set by mistake especially for measurements on objects with a high signal voltage.

IEC/IEEE-bus command: `INP:ATT:PROT ON`

AMPT – NEXT menu:



The *REF LEVEL POSITION* softkey allows the reference level position to be entered.

The setting range is from -200 to +200%, 0% corresponding to the lower and 100% to the upper limit of the diagram.

IEC/IEEE-bus command: `DISP:WIND:TRAC:RPOS 100PCT`



The *REF LEVEL OFFSET* softkey allows the arithmetic level offset to be entered. This offset is added to the measured level irrespective of the selected unit. The scaling of the Y axis is changed accordingly.

The setting range is ± 200 dB in 0.1 dB steps.

IEC/IEEE-bus command: `DISP:WIND:TRAC:RLEV:OFFS -10dB`

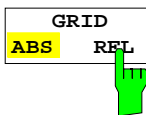

The *GRID ABS/REL* softkey switches between absolute and relative scaling of the level axis.

GRID ABS is the default setting.

ABS The labelling of the level lines refers to the absolute value of the reference level.

REL The upper line of the grid is always at 0 dB.
The scaling is in dB whereas the reference level is always in the set unit (dBm, dB μ V,...).

For setting *RANGE LINEAR* (linear scaling, labelling of axes in %) the softkey is not displayed since the unit % itself implies a relative scale.

IEC/IEEE-bus command: `DISP:WIND:TRAC:Y:MODE ABS`

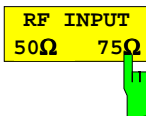

The *RF INPUT 50 Ω / 75 Ω* softkey switches the input impedance of the instrument between 50 Ω (= default setting) and 75 Ω .

The setting 75 Ω should be used if the input impedance (50 Ω) is transformed to 75 Ω using the corresponding adapter unit of type RAZ (= 25 Ω in series to the input impedance of the analyzer). The correction value used for the adaption is 1.76 dB = $10 \log (75\Omega / 50\Omega)$.

All levels specified in this operating manual refer to the default setting of the instrument (50 Ω).

IEC/IEEE-bus command: `INP:IMP 50OHM`

Setting the Bandwidths and Sweep Time – BW Key

The *BW* key calls a menu for setting the resolution bandwidth (*RBW*), video bandwidth (*VBW*) and sweep time (*SWT*) for the frequency sweep. The parameters may be coupled dependent on the span (stop minus start frequency) or freely set by the user. When working with a split screen display, the settings always refer to the active window.

The R&S ESCI offers resolution bandwidths from 10 Hz to 3 MHz in 1, 3, 10 steps:

Resolution bandwidths up to 120 kHz are realized using digital bandpasses with Gaussian characteristics. As far as the attenuation characteristic is concerned they behave like analog filters but have a much higher measurement speed than comparable analog filters. This is due to the fact that the transient response can be compensated as a result of an accurately defined filter behaviour.

Bandwidths above 300 kHz are realized using decoupled 4-circuit LC filters.

As an alternative to the analog filters, FFT filters are available for the bandwidths between 1 Hz and 30 kHz. When working with bandwidths up to 30 kHz, the FFT algorithm offers considerably higher measurement speeds with all the other settings remaining the same. The reason is that with analog filters the sweep time required for a particular span is proportional to $(\text{Span}/\text{RBW}^2)$. When using the FFT algorithm, however, the sweep time is proportional to (Span/RBW) .

The video bandwidths are available in 1, 3, 10 steps between 1 Hz and 10 MHz. They can be set in accordance with the resolution bandwidth.

The video filters serve for smoothing the displayed trace. Video bandwidths that are small compared to the resolution bandwidth average out noise peaks and pulsed signals, so that only the signal average is displayed. If pulsed signals are to be measured, it is recommended to use a video bandwidth that is large compared to the resolution bandwidth ($\text{VBW} \geq 10 \times \text{RBW}$) for the amplitudes of pulses to be measured correctly.

Note: For analog and digital filters, the R&S ESCI has overload reserves of different magnitude above the reference level. Due to the LO breakthrough the overload display OVLD responds with digital filters with $\text{RBW} < 100 \text{ kHz}$, as soon as the start frequency is selected $< 6 \times$ resolution bandwidth, for $\text{RBW} = 100 \text{ kHz}$, as soon as the start frequency is below 3 MHz.

BW menu:

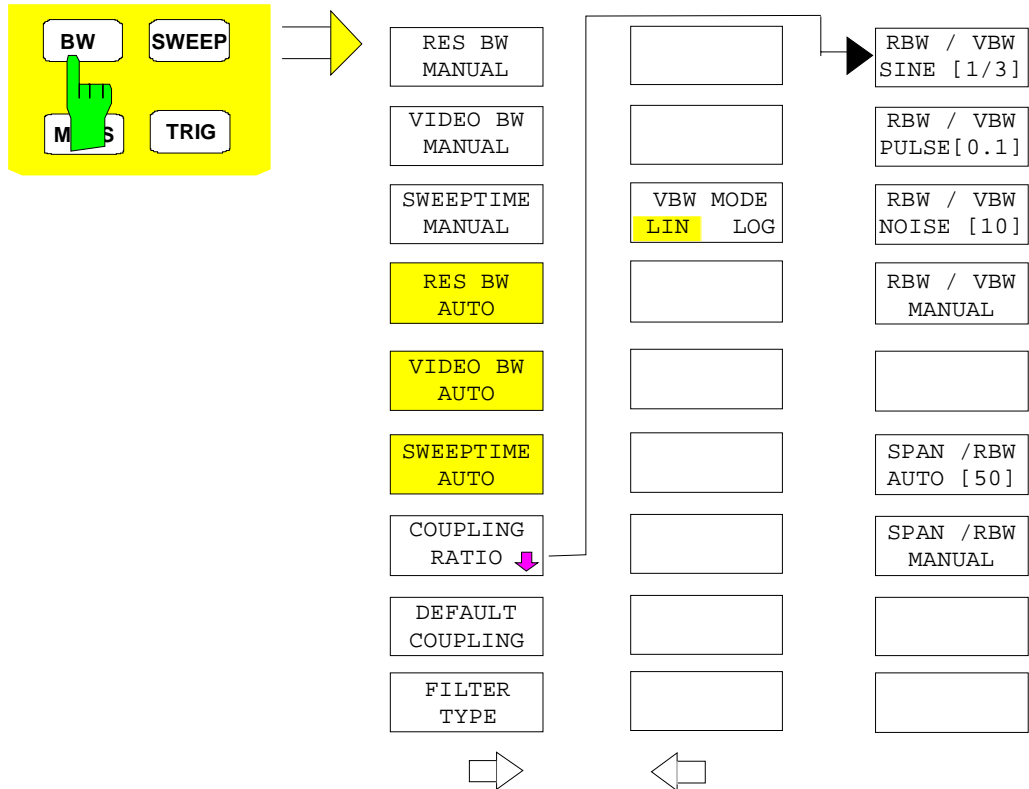

The *BW* key opens a menu for setting the resolution bandwidth, the video bandwidth, the sweep time and their couplings.

The .. *BW AUTO* softkeys are used to couple the functions. The coupling ratios are selected by means of the *COUPLING RATIO* softkey.

The .. *BW MANUAL* softkeys allow a parameter to be entered. This parameter is not coupled to the other parameters.

Note: *With the ... BW AUTO softkeys the resolution bandwidth, the video bandwidth and the sweep time can be entered separately for the frequency domain (span > 0 Hz) and the time domain (span = 0 Hz).
But with ...BW MANUAL softkeys the selected values apply to both the frequency and time domain.*

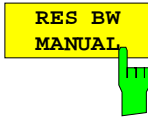

The *RES BW MANUAL* softkey activates the manual data entry for the resolution bandwidth.

The resolution bandwidth can be selected in 1/3/10 steps in the range between 10 Hz and 3 MHz. The nominal resolution bandwidth is the 3 dB bandwidth.

When FFT filters are used, the lower limit of the bandwidth is 1 Hz. FFT filters may be used with bandwidths up to 30 kHz.

For numeric inputs, the values are always rounded to the nearest possible bandwidth. For rollkey or UP/DOWN key inputs, the bandwidth is adjusted in steps either upwards or downwards.

For filter type CHANNEL or RRC the bandwidth is selected from the list of available channel filters given at the end of this chapter. For data entry, the cursor keys \uparrow and \downarrow scroll through this list.

The manual input mode of the resolution bandwidth is indicated by a green terisk (*) on the display.

IEC/IEEE-bus command: BAND:AUTO OFF;
 BAND 1MHz

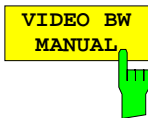

The *VIDEO BW MANUAL* softkey activates the manual data entry for the video bandwidth.

The video bandwidth can be selected in 1/ 3/ 10 steps in the range between 1 Hz and 10 MHz.

For numeric inputs, the values are always rounded to the nearest possible allowed bandwidth. For rollkey or UP/DOWN key inputs, the bandwidth is adjusted in steps either downwards or upwards.

The manual input mode of the video bandwidth is indicated by a green terisk (*) on the display.

IEC/IEEE-bus command: BAND:VID:AUTO OFF;
 BAND:VID 10 kHz

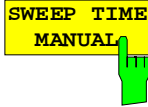

The *SWEPTIME MANUAL* softkey activates the manual data entry for the sweep time. At the same time, the coupling of the sweep time is cancelled. Other couplings (*VIDEO BW*, *RES BW*) remain effective.

In the frequency domain (span > 0 Hz) and for resolution bandwidths above 1 kHz, the allowed sweep times for spans > 3.2 kHz range from 2.5 ms through to 16000 s. With spans below 3.2 kHz, the maximum allowed sweep time is reduced to 5 s * span/Hz.

If FFT filters are used, the sweep time is fixed by the span and the bandwidth and therefore cannot be set.

In time domain (span = 0 Hz), the range of sweep times is 1 μ s to 16000 s is selectable in steps of max. 5% of the sweep time. For numeric inputs, rounding is made to the nearest possible sweep time. For rollkey or UP/DOWN key inputs, the sweep time is adjusted in steps either downwards or upwards.

The manual input mode of the sweep time is indicated by a green asterisk (*) on the display. If the selected sweep time is too short for the selected bandwidth and span, level measurement errors will occur. This happens because the available settling time for the resolution or video filters is too short. In this case, the R&S ESCI outputs *UNCAL* on the display and marks the indicated sweep time with a red asterisk (*).

IEC/IEEE-bus command: `SWE:TIME:AUTO OFF;`
 `SWE:TIME 10s`

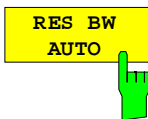

The *RES BW AUTO* softkey couples the resolution bandwidth to the selected span. Changing the span causes automatic adjustment of the resolution bandwidth.

Automatic coupling of resolution bandwidth to span is always recommended when a favourable setting of the resolution bandwidth in relation to the selected span is desired for the measurement under request.

The coupling ratio is set in the *COUPLING RATIO* submenu.

The *RES BW AUTO* softkey is only available in the frequency domain (span > 0 Hz). The softkey is blanked in the time domain.

IEC/IEEE-bus command: `BAND:AUTO ON`

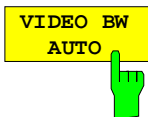

The *VIDEO BW AUTO* softkey couples the video bandwidth to the resolution bandwidth. If the resolution bandwidth is changed, the video bandwidth is automatically adjusted.

The coupling of the video bandwidth is always recommended when the minimum sweep time is required for a selected resolution bandwidth. Narrower video bandwidths require longer sweep times due to the longer settling time. Wider bandwidths reduce the signal/noise ratio.

The coupling ratio is set in the *COUPLING RATIO* submenu.

The coupling of the video bandwidth to the resolution filter is also permitted for the time domain display (span = 0).

IEC/IEEE-bus command: `BAND:VID:AUTO ON`

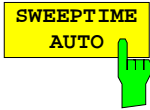

The *SWEPTIME AUTO* softkey couples the sweep time to the span, video bandwidth (VBW) and resolution bandwidth (RBW). The sweep time is automatically adjusted on any change in span, resolution bandwidth or video bandwidth.

The softkey is only available in the frequency domain (span >0 Hz). It is blanked in the time domain.

The R&S ESCI always selects the shortest sweep time possible without falsifying the signal. The maximum level error compared to using a longer sweep time is < 0.1 dB. If additional bandwidth and level errors are to be avoided, the sweep time is to be set to three times the time offered in coupled mode.

IEC/IEEE-bus command: `SWE:TIME:AUTO ON`

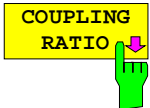

RBW / VBW
SINE [1/3]

The *COUPLING RATIO* softkey opens a sub menu for selection of the coupling ratios.

RBW / VBW
PULSE [.1]

When the default setting is active, i.e. the *COUPLING RATIO* softkey is deactivated (not highlighted), the ratio span/resolution bandwidth (SPAN/RBW) is 50 (this corresponds to SPAN / RBW AUTO [50]) and the ratio resolution bandwidth/video bandwidth (RBW/VBW) is 0.33 (this corresponds to RBW / VBW SINE [1/3]).

RBW / VBW
NOISE [10]

RBW / VBW
MANUAL

Blanked softkey

If the ratio RBW/VBW or SPAN/RBW is different from the default setting, the *COUPLING RATIO* softkey is highlighted.

SPAN / RBW
AUTO [50]

The softkeys RBW/VBW... are selection keys. Only one softkey can be enabled at any one time. The softkeys are only effective for the *VBW AUTO* selection in the main menu.

SPAN / RBW
MANUAL

The softkeys SPAN/RBW... are also selection keys. They are only effective for the *RBW AUTO* selection in the main menu.

Blanked softkey

Blanked softkey

RBW / VBW
SINE [1/3]

The *RBW/VBW SINE [1/3]* softkey sets the following coupling ratio:
video bandwidth = 3 x resolution bandwidth.

This is the default setting for the coupling ratio resolution bandwidth/video bandwidth.

This is the coupling ratio recommended if sinusoidal signals are to be measured.

IEC/IEEE-bus command `BAND:VID:RAT 3`

This setting is only effective for the *VBW AUTO* selection in the main menu.

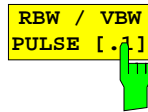

The *RBW/VBW PULSE [.1]* softkey sets the following coupling ratio:

video bandwidth = 10 x resolution bandwidth or
video bandwidth = 10 MHz (= max. VBW).

This coupling ratio is recommended whenever the amplitudes of pulsed signals are to be measured correctly. The IF filter is exclusively responsible for pulse shaping. No additional evaluation is performed by the video filter.

IEC/IEEE-bus command `BAND:VID:RAT 10`

This setting is only effective for the *VBW AUTO* selection in the main menu.

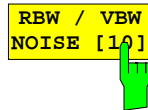

The *RBW/VBW NOISE [10]* softkey sets the following coupling ratio:

video bandwidth = resolution bandwidth/10

At this coupling ratio, noise and pulsed signals are suppressed in the video domain. For noise signals, the average value is displayed.

IEC/IEEE-bus command `BAND:VID:RAT 0.1`

This setting is only effective for the *VBW AUTO* selection in the main menu.

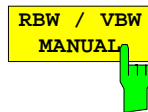

The *RBW/VBW MANUAL* softkey activates the manual input of the coupling ratio.

The resolution bandwidth/video bandwidth ratio can be set in the range 0.001 to 1000.

IEC/IEEE-bus command `BAND:VID:RAT 10`

This setting is only effective for the *VBW AUTO* selection in the main menu.

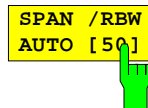

The *SPAN/RBW AUTO [50]* softkey sets the following coupling ratio:

resolution bandwidth = span/50

This coupling ratio is the default setting of the R&S ESCI

IEC/IEEE-bus command `BAND:RAT 0.02`

This setting is only effective for the *RBW AUTO* selection in the main menu.

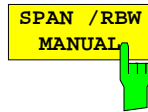

The *SPAN/RBW MANUAL* softkey activates the manual input of the coupling ratio.

The span / resolution bandwidth ratio can be set in the range 1 to 10000.

IEC/IEEE-bus command `BAND:RAT 0.1`

This setting is only effective for the *RBW AUTO* selection in the main menu.

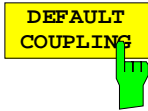

The *DEFAULT COUPLING* softkey sets all coupled functions to the default state (*AUTO*). In addition, the ratio *RBW/VBW* is set to *SINE [1/3]* and the ratio *SPAN/RBW* to 50 in the *COUPLING RATIO* submenu (default setting, *COUPLING RATIO* softkey not highlighted).

IEC/IEEE-bus command `BAND:AUTO ON`
`BAND:VID:AUTO ON`
`SWE:TIME:AUTO ON`

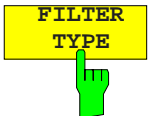

The *FILTER TYPE* softkey opens the selection list for different filter types. In the range up to 30 kHz digital band filters with Gaussian characteristic and filtering with FFT algorithm can be selected.

FILTER TYPE	
<input checked="" type="checkbox"/>	NORMAL (3dB)
<input type="checkbox"/>	NORMAL (6dB)
<input type="checkbox"/>	FFT
<input type="checkbox"/>	CHANNEL
<input type="checkbox"/>	RRC

NORMAL(3dB)

The resolution bandwidths are implemented by Gaussian filters with the set 3 dB bandwidth and correspond approximately to the noise bandwidth. For bandwidths up to 100 kHz, digital bandpass filters are used.

NORMAL(6dB)
 The resolution bandwidths are implemented by Gaussian filters with the set 6 dB bandwidth and correspond approximately to the pulse bandwidth. For bandwidths up to 120 kHz, digital bandpass filters are used

FFT

An FFT is performed. For that purpose, the filtered IF signal is digitized and then transformed into the spectral domain via FFT. The transformation range depends on the selected filter bandwidths and can be set between 4 kHz to 50 kHz. If the span is larger than the transformation range, several transformations are performed and the results are appended to each other in the spectral domain.

If the span is smaller than the transformation range, the measurement results are interpolated when the number of measurement points provided by the FFT is smaller than the number of display points in x-direction (501). A flattop window serves as a window in the time domain so that high amplitude precision with good selection is achieved.

If the span is smaller than the transformation range, the measurement results are interpolated when the number of measurement points provided by the FFT is smaller than the number of display points in x-direction (501). A flattop window serves as a window in the time domain so that high amplitude precision with good selection is achieved.

Sweep time	Defined by the selected bandwidth and span (reason: FFT filtering is a block transformation). It cannot be changed (softkey deactivated).
Detector	Sample detector and peak detector are available. Peak detector is active when AUTO SELECT is selected.
Video bandwidth	Not defined in case of FFT; therefore cannot be set (softkeys deactivated).

Compared to bandpasses, FFT filters lead to significantly reduced sweep times. For a span of 50 kHz and a bandwidth of 100 Hz, for instance, the sweep time is reduced from 5 s to 40 ms. FFT filters are particularly suitable for stationary signals (sinusoidal signals or signals that are continuously modulated in time). For burst signals (TDMA) or pulsed signals, normal filters are preferable.

Note:

As soon as the FFT filters are active ($RBW \leq 30$ kHz) the sweep time display field (SWT) is replaced by the acquisition time (AQT) display field.

FFT is a block transformation so the result depends on the time relation between the data set to be transformed and the burst or pulsed signal. A gated sweep measurement for TDMA signals is therefore not provided if FFT filters are used.

When the tracking generator (option R&S FSP-B9) is used as signal source for the DUT, filtering with the FFT algorithm is not useful. The selection FFT is thus not available if the tracking generator is switched on.

Additionally, a number of especially steep-edged channel filters are available for power measurement.

A distinction is made between the following filter types:

CHANNEL = general, steep-edged channel filters
 RRC = filters with root-raised cosine characteristic
 (RRC = Root Raised Cosine)

When selecting these filter types, the automatic coupling of the resolution bandwidth to the span is not available. The filters are selected via the *RES BW* softkey.

A list of all available channel filters with their associated applications can be found at the end of this chapter.

IEC/IEEE-bus command: BAND:TYPE NORM

List of available channel filters

The channel filters included in the following table are can be activated via the *FILTER TYPE* softkey and are then available as resolution filters (softkey *RES* available for firmware version 1.10 or higher. They *BW*).

Note:

For filters of type *RRC* (Root Raised Cosine), the filter bandwidth indicated describes the sampling rate of the filter.

For all other filters (*CFILter*) the filter bandwidth is the 3 dB bandwidth.

Filter Bandwidth	Filter Type	Application
100 Hz 200 Hz 300 Hz 500 Hz	CFILter CFILter CFILter CFILter	A0
1 kHz 1.5 kHz 2 kHz 2.4 kHz 2.7 kHz 3 kHz 3.4 kHz 4 kHz 4.5 kHz 5 kHz 6 kHz 8.5 kHz 9 kHz	CFILter CFILter CFILter CFILter CFILter CFILter CFILter CFILter CFILter CFILter CFILter CFILter CFILter	SSB DAB, Satellite ETTS300 113 (12.5 kHz channels) AM Radio
10 kHz 12.5 kHz 14 kHz 15 kHz 16 kHz 18 kHz, $\alpha=0.35$ 20 kHz 21 kHz 24.3 kHz, $\alpha=0.35$ 25 kHz 30 kHz 50 kHz	CFILter CFILter CFILter CFILter RRC CFILter CFILter RRC CFILter CFILter CFILter	CDMAone ETTS300 113 (20 kHz channels) ETTS300 113 (25 kHz channels) TETRA PDC IS 136 CDPD, CDMAone
100 kHz 150 kHz 192 kHz 200 kHz 300 kHz 500 kHz	CFILter CFILter CFILter CFILter CFILter	FM Radio PHS J.83 (8-VSB DVB, USA)
1.0 MHz 1.2288 MHz 1.5 MHz 2.0 MHz *) 3.0 MHz *) 3.84 MHz, $\alpha=0.22$ *) 4.096 MHz, $\alpha=0.22$ *) 5.0 MHz *)	CFILter CFILter CFILter CFILter CFILter RRC RRC CFILter	CDMAone CDMAone DAB W-CDMA 3GPP W-CDMA NTT DOCoMo

*) This filter is available with hardware index > 2 of the IF filter module (see softkey *SETUP - SYSTEM INFO - HARDWARE INFO*).

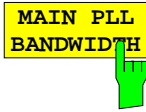

The MAIN PLL BANDWIDTH softkey defines the bandwidth of the main PLL of the analyzer synthesizer and thus influences the phase noise of the analyzer. Three bandwidth settings are possible (High / Medium / Low); if AUTO is selected, the bandwidth is set automatically (default).

IEC/IEEE-bus command: `BAND:PLL AUTO`

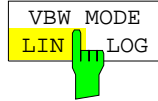

The *VBW MODE LIN/LOG* softkey determines the position of the video filter in the signal path for resolution bandwidths ≤ 100 kHz:

- If LINear is selected, the video filter will be in front of the logarithmic amplifier (default).
- If LOGarithmic is selected, the video filter will be behind the logarithmic amplifier.

The essential difference between the two operating modes relates to the settling in the case of falling signal edges:

With LINear, the falling signal edge will be "flatter" than with LOGarithmic. This is due to the conversion from linear power to logarithmic level units: a reduction of the linear power by 50% reduces the logarithmic signal level by only 3 dB.

IEC/IEEE-bus-command: `BAND:VID:TYPE LIN`

Sweep Settings – SWEEP Key

The SWEEP key serves for configuring the sweep mode.

SWEEP menu

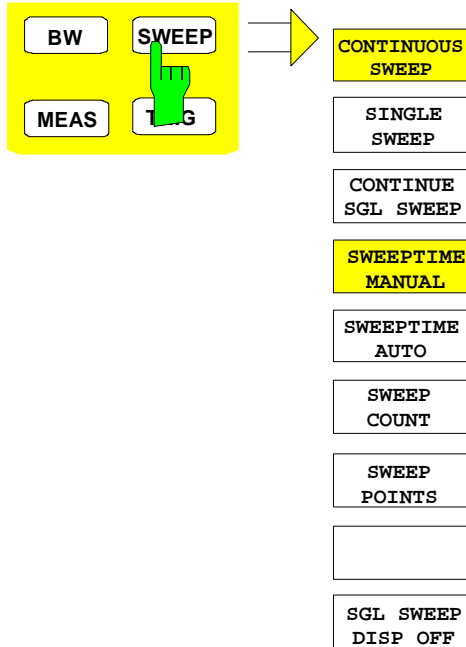

The *SWEEP* key calls a menu in which the sweep mode is defined. In split-screen mode, the entries made are valid for the active window only.

The *CONTINUOUS SWEEP*, *SINGLE SWEEP* and *SGL SWEEP DISP OFF* softkeys are mutually exclusive selection keys.

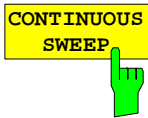

The *CONTINUOUS SWEEP* softkey activates the continuous sweep mode, which means that the sweep takes place continuously according to the trigger mode set.

When working in the split-screen mode and with different settings in the two windows, screen A is swept first, followed by screen B. When the softkey is pressed, the sweep is restarted.

CONTINUOUS SWEEP is the default setting of R&S ESCI.

IEC/IEEE-bus command: `INIT:CONT ON`

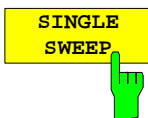

The *SINGLE SWEEP* softkey starts n sweeps after triggering. The number of sweeps is determined by the *SWEEP COUNT* softkey.

When working in the split-screen mode, the frequency ranges of the two windows are swept one after the other.

If a trace is swept using *TRACE AVERAGE* or *MAXHOLD*, the value set via the *SWEEP COUNT* softkey determines the number of sweeps. If 0 has been entered, one sweep is performed.

IEC/IEEE-bus command: `INIT:CONT OFF`

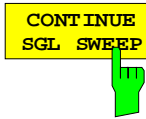

The *CONTINUE SGL SWEEP* softkey repeats the number of sweeps set under *SWEEP COUNT*, however without first deleting the trace.

This is particularly of interest when using the functions *TRACE AVERAGE* and *MAXHOLD*, if previously recorded measurement results are to be taken into consideration for averaging / maximum search.

If *SGL SWEEP DISP OFF* is active, the screen is switched off also during repeated sweeps.

IEC/IEEE-bus command: `INIT:CONM`

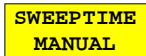

The *SWEPTIME MANUAL* softkey activates the window for entering the sweep time manually (see also BW menu).

IEC/IEEE-bus command: `SWE:TIME 10s`

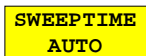

The *SWEPTIME AUTO* softkey activates the automatic selection of the sweep time as a function of the bandwidth of the resolution and video filters (see also BW menu).

IEC/IEEE-bus command: `SWE:TIME:AUTO ON`

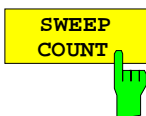

The *SWEEP COUNT* softkey activates the window for the entry of the number of sweeps to be performed by R&S ESCI after a single sweep has been started. If Trace Average, Max Hold or Min Hold is activated, this also determines the number of averaging or maximum search procedures.

Example:

[TRACE1: MAX HOLD]

[SWEEP: SWEEP COUNT: {10} ENTER]

[SINGLE SWEEP]

R&S ESCI performs the Max Hold function over 10 sweeps.

The permissible range for the sweep count is 0 to 32767. For sweep count = 0 or 1, one sweep is performed. For trace averaging in the continuous-sweep mode, R&S ESCI performs running averaging over 10 sweeps if sweep count = 0; if sweep count = 1, no averaging is performed.

The sweep count is valid for all the traces in a diagram.

Note: *The number of sweeps set in the TRACE menu is the same as that in the SWEEP menu.*

If SINGLE SWEEP is selected, the measurement stops after the selected number of sweeps has been performed.

IEC/IEEE-bus command: `SWE:COUN 64`

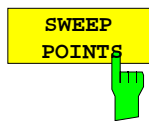

The *SWEEP POINTS* softkey selects the number of measurement samples acquired during a sweep.

The following numbers of points per sweep are available:
251, 501 (Default), 1001, 2001, 4001, 8001.

Note:

The autopeak detector will be disabled while the number of points per sweep is \neq 501.

IEC/IEEE-bus command: SWE:POIN 501



The *SGL SWEEP DISP OFF* softkey deactivates the display while a single sweep is being performed. Once the sweep has been completed, the trace is shown.

IEC/IEEE-bus command: INIT:DISP OFF;:INIT

Triggering the Sweep – TRIG Key

The *TRIG* key opens a menu for selection of the various trigger sources, trigger polarity and external gate function. The active trigger mode is indicated by highlighting the corresponding softkey.

For video trigger, a trigger threshold can be entered, which is represented in the diagram as a horizontal line.

To indicate that a trigger mode other than *FREE RUN* has been set, the enhancement label **TRG** is displayed on the screen. If two windows are displayed, TRG appears next to the appropriate window.

The option *TV and RF Trigger* (R&S FSP-B6) adds a number of trigger functions for the analysis of TV signals to this menu (see section Option FSP-B6 – TV and RF Trigger, page 4.100).

TRIGGER menu

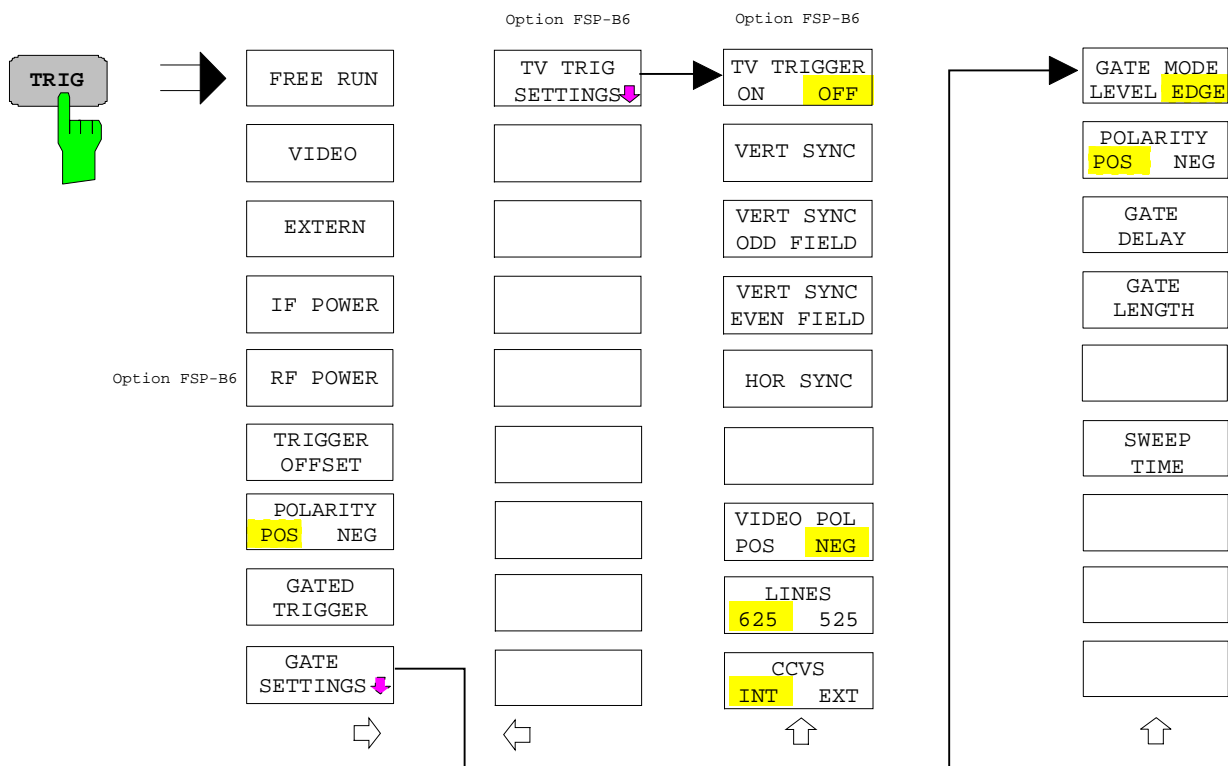

The *FREE RUN* softkey activates the free-run sweep mode, i.e. start of a sweep is not triggered. Once a measurement is completed, another is started immediately.

FREE RUN is the default setting of R&S ESCI.

IEC/IEEE-bus command: TRIG:SOUR IMM

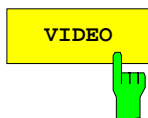

The *VIDEO* softkey activates triggering through the displayed voltage.

For the video triggering mode, a horizontal trigger line is shown in the diagram. It may be used to set the trigger threshold between 0% and 100% of the overall diagram height.

IEC/IEEE-bus command: TRIG:SOUR VID
TRIG:LEV:VID 50 PCT

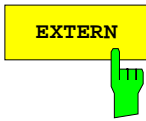

The *EXTERN* softkey activates triggering via a TTL signal at the input connector *EXT TRIGGER/GATE* on the rear panel.

IEC/IEEE-bus command: TRIG:SOUR EXT
 SWE:EGAT:SOUR EXT

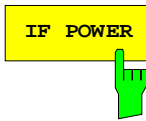

The *IF POWER* softkey activates triggering of the measurement via signals which are outside the measurement channel.

For this purpose, the R&S ESCI uses a level detector at the second intermediate frequency. can be selected in a range between -30 dBm and -10 dBm at the input mixer. The resulting trigger level at the RF input is calculated via the following formula:

$$Mixerlevel_{min} + RFA_{Att} - PreampGain \leq Input\ Signal \leq Mixerlevel_{max} + RFA_{Att} - PreampGain$$

The bandwidth at the intermediate frequency is 10 MHz. The R&S ESCI is triggered as soon as the trigger threshold is exceeded within a 5 MHz range around the selected frequency (= start frequency in the frequency sweep).

Thus, the measurement of spurious emissions, e.g. for pulsed carriers, is possible even when the carrier lies outside the selected frequency span.

IEC/IEEE-bus command: TRIG:SOUR IFP
 SWE:EGAT:SOUR IFP



The *TRIGGER OFFSET* softkey activates the window for entering the time offset between the trigger signal and the start of the sweep.

Triggering is delayed by the entered time with respect to the trigger signal (time entered > 0) or is started earlier (time entered < 0). The time may be entered in multiples of 125 ns in the range -100 s to 100 s (default 0 s).

Note: A negative offset (pretrigger) can be set in the time domain only (SPAN = 0 Hz) provided GATED TRIGGER is not active in that domain.

The maximum allowed range and the maximum resolution of the pretrigger is limited by the set sweep time:

max. range = - 499/500 x sweep time

max. resolution = sweep time/500.

Pretriggering is not possible when the rms or the average detector is activated

As a common input signal is used for both trigger and gate when selecting *EXTERN* and *IF POWER*, changes to the gate delay will affect the trigger delay (*TRIGGER OFFSET*) as well.

IEC/IEEE-bus command: TRIG:HOLD 10US



The *POLARITY POS/NEG* softkey selects the polarity of the trigger source.

The sweep starts after a positive or negative edge of the trigger signal. The selected setting is highlighted.

The selection is valid for all trigger modes with the exception of *FREE RUN*; in the gate mode, it also applies to the gate polarity.

The default setting is *POLARITY POS*.

IEC/IEEE-bus command: TRIG:SLOP POS

By using a gate in sweep mode and stopping the measurement while the gate signal is inactive, the spectrum for pulsed RF carriers can be displayed without the superposition of frequency components generated during switching. Similarly, the spectrum can also be examined for an inactive carrier. The sweep can be controlled by an external gate or by the internal power trigger.

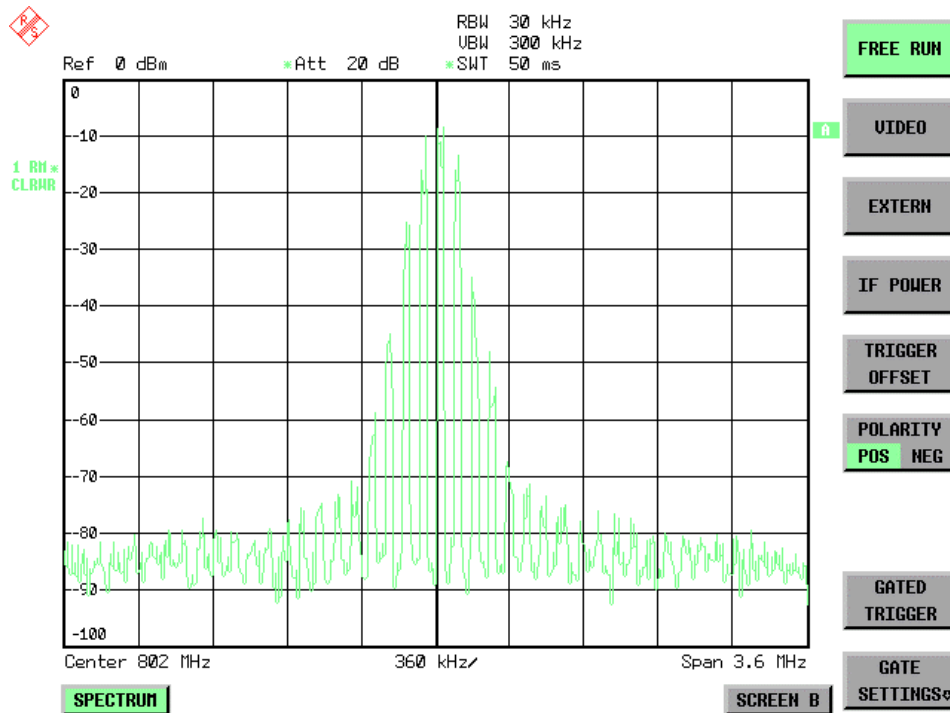

Fig. 4-9 Pulsed signal GATE OFF

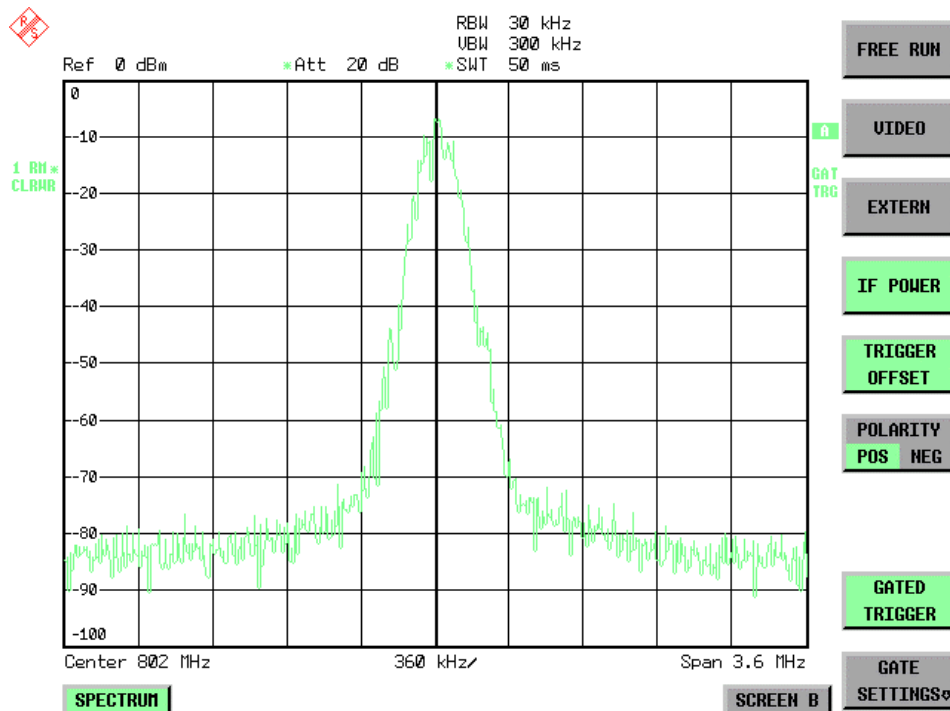
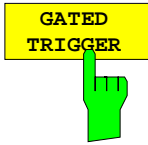

Fig. 4-10 TDMA signal with GATE ON

The gated-sweep mode is activated by the *GATED TRIGGER* softkey. The setting of the mode takes place in the *GATE SETTINGS* submenu.



The *GATED TRIGGER* softkey switches the sweep mode with gate on and off.

When gate is switched on, a gate signal applied to the rear panel connector *EXT TRIGGER/GATE* or the internal IF power detector controls the sweep of the analyzer. This selection is made via the *EXTERN* and *IF POWER* softkeys for trigger and gate.

The length of the gate signal defines when the sweep is to be interrupted. Here a differentiation is made between edge-triggered and level-triggered modes: in case of edge triggering the gate length can be set via the *GATE LENGTH* softkey, while in case of level triggering the gate length depends on the length of the gate signal.

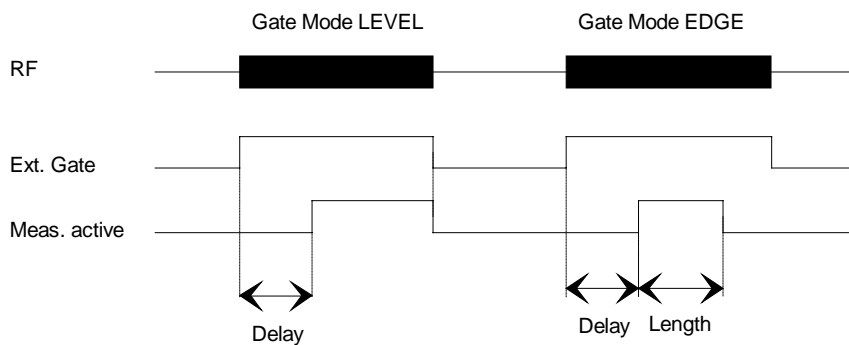

Fig.4-11 Timing diagram for GATE, GATE DELAY and GATE LENGTH

This softkey requires the *EXTERN* or *IF POWER* trigger mode. If a different mode is active, *IF POWER* is automatically selected.

Gated-sweep operation is also possible in the time domain. This enables - e.g. in burst signals - level variations of individual slots to be displayed versus time.

To indicate that a gate is used for the sweep, the enhancement label **GAT** is displayed on the screen. This label appears to the right of the window for which the gate is configured.

```
IEC/IEEE-bus command:  SWE:EGAT  ON
                        SWE:EGAT:SOUR  IFP
                        or:
                        SWE:EGAT:SOUR  EXT
```

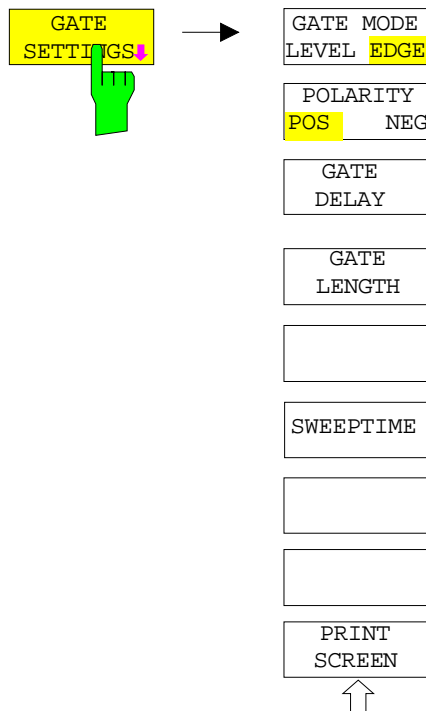

The *GATE SETTINGS* softkey calls a submenu for making all the settings required for gated-sweep operation.

At the same time, a transition is made to the time domain (span = 0) and the time parameters *GATE DELAY* and *GATE LENGTH* are represented as vertical lines. This allows the required gate time parameters to be set easily.

For highly accurate setting of gate delay and gate length, the x axis can be altered using the *SWEPTIME* softkey in a way that the signal range concerned (e.g. one full burst) is displayed.

Then the sampling time and duration can be set by *GATE DELAY* and *GATE LENGTH* in a way that the desired portion of the signal is shown.

When quitting the submenu, the program will return to the frequency domain provided it was active before. The original span is restored so the desired measurement can now be performed with the accurately set gate.

IEC/IEEE-bus command: --

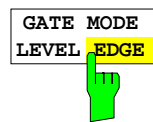

The *GATE MODE LEVEL/EDGE* softkey selects the trigger mode. Gated sweep is possible in the level-triggered as well as in the edge-triggered mode.

If level triggering is selected, the *GATE LENGTH* softkey becomes inactive and cannot be operated.

IEC/IEEE-bus command: SWE:EGAT:TYPE EDGE



The *POLARITY POS/NEG* softkey controls the polarity of the *EXT TRIGGER/GATE* control line.

In case of level triggering the sweep is stopped by *POLARITY POS* and a logic '0' signal; the signal '1' will restart the sweep after the *GATE DELAY* time has elapsed.

In case of edge triggering the sweep is continued on a '0' to '1' transition for the duration of *GATE LENGTH* after a delay (*GATE DELAY*) has elapsed.

Changing the polarity automatically implies a transition of the trigger-edge polarity (*POLARITY* softkey in the higher menu).

IEC/IEEE-bus command: SWE:EGAT:POL POS

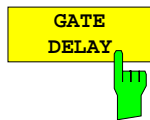

The *GATE DELAY* softkey activates the window for setting the delay time between the gate signal and the continuation of the sweep.

This may be useful for taking into account a delay between the gate signal and the stabilization of an RF carrier for example.

As gate delay, values between 125 ns and 100 s may be set. The position of the delay on the time axis in relation to the sweep is indicated by the line labelled **GD**.

As there is a common input signal for trigger and gate if *EXTERN* or *IF POWER* is selected, changes to the gate delay will affect the trigger delay (*TRIGGER OFFSET*) as well.

IEC/IEEE-bus command: `SWE:EGAT:HOLD 1US`

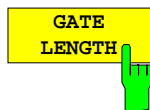

The *GATE LENGTH* softkey activates the window for setting the sweep duration of R&S ESCI in the edge-triggered mode. Values between 125 ns and 100 s may be set for the gate length. The length of the gate in relation to the sweep is indicated by the line labelled **GL**.

This softkey is only available if *GATE MODE EDGE* (edge triggering) has been selected.

IEC/IEEE-bus command: `SWE:EGAT:LENG 100US`

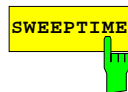

The *SWEEP TIME* softkey enables the user to change the time axis to obtain a higher resolution for positioning gate delay and gate length.

When this is to be done, the sweep time temporarily changes; the original value is restored when the menu is quit.

IEC/IEEE-bus command: `--`

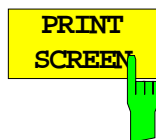

The *PRINT SCREEN* softkey allows the gate settings to be output on a printer.

IEC/IEEE-bus command: `--`

Measurement example:

The modulation spectrum of a GSM or PCS1900 signal is to be measured using the gated-sweep function. The signal is generated by a Signal Generator SME03 whose RF output is directly connected to the RF input of R&S ESCI.

The modulation spectrum of a GSM 900 signal is to be measured using the gated-sweep function. The signal is generated by a Signal Generator SME03 whose RF output is directly connected to the RF input of R&S ESCI.

Settings on SME03:

FREQ: 802 MHz
 Level: 0 dBm: Return
 Digital Mod: Select: GMSK: Select
 Source: Select: PRBS: Select: Return
 Level Attenuation: Select: 60 dB: Return

The SME03 supplies a GMSK-modulated TDMA signal (GSM).

Settings on R&S ESCI:

Conventions: **[KEY]** Menu called by this key. All information between the brackets refers to this menu.
 {Number} Numeric value to be entered for the parameter on hand.
 SOFTKEY Softkey to be used for making a selection or entering a value.

[PRESET]

[FREQ: **CENTER {802} MHz]**
[SPAN **{3.6} MHz]**
[AMPT: **REF LEVEL {0} dBm: RF ATTEN MANUAL: {10} dB]**
[BW: **RES BW MANUAL: {30} kHz]**
[TRACE : **TRACE 1 DETECTOR: RMS]**
[SWEEP: **SWEEPTIME MANUAL: {50} ms]**
[TRIG: **EXTERN**
 GATED TRIGGER;
 GATE SETTINGS: GATE MODE EDGE; POLARITY POS
 SWEEPTIME MANUAL {1} ms: GATE DELAY {300} μs:
 GATE LENGTH: {250} μs]

The following figure shows the screen display for setting gate parameters. The vertical lines for gate delay (GD) and gate length (GL) can be adjusted to the burst signal by entering numeric values or by means of the rollkey.

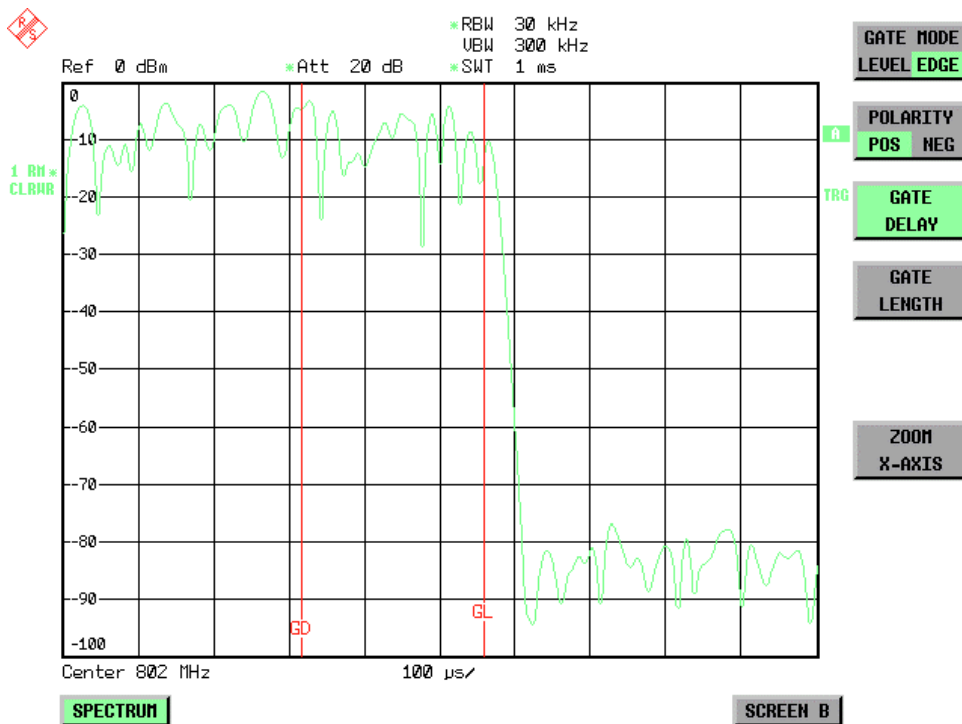

Fig.4-12 Setting GATE DELAY and GATE LENGTH in time domain by means of lines GD and GL

On quitting the *GATE SETTINGS* menu, R&S ESCI returns to the previous screen.

Option R&S FSP-B6 – TV and RF Trigger

The option TV and RF Trigger, R&S FSP-B6, enables the R&S ESCI to trigger on TV signals or on the presence of a RF carrier outside the resolution bandwidth.

For this purpose, the hardware board is equipped with a TV demodulator, which produces the trigger signals necessary for the analysis of TV signals. In addition to the pure trigger function, the board also creates a demodulated CCVS video signal for operation of external TV monitors. Apart from using the internal IF for creating the trigger signals, the R&S ESCI can also make use of an externally supplied CCVS signal; the corresponding connector is placed at the rear panel of the instrument.

In order to display different sections of a TV video signal, the R&S ESCI derives several trigger signals from the video signals. This allows triggering as well on the frame repetition as on each line of the TV video signal.

Additionally, the option includes a broadband RF detector (bandwidth = 12 MHz), which allows triggering within a 6 MHz range around the selected frequency (= start frequency in the frequency sweep). Thus, the measurement of spurious emissions, e.g. for pulsed carriers, is possible even when the carrier lies outside the selected frequency span. This RF power trigger can be used as long as the RF signal at the input mixer is in the range of -10 dBm to -50 dBm. The resulting range for the input signal at the RF input connector can be calculated using the following formula:

$$Mixerlevel_{\min} + RFAtt - Pr eampGain \leq Input\ Signal \leq Mixerlevel_{\max} + RFAtt - Pr eampGain$$

The RF Power Trigger can be selected and configured in the trigger menu (TRIG) using the softkey RF POWER:

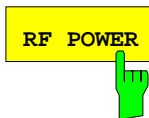

The *RF POWER* softkey activates triggering of the measurement via signals which are outside the measurement channel.

The R&S ESCI uses a level detector at the first IF. The detector's threshold can be selected from values between -50 dBm and -10 dBm at the input mixer. The range of the input signal to which the trigger responds is calculated using the following formula.

$$Mixerlevel_{\min} + RFAtt - Pr eampGain \leq Input\ Signal \leq Mixerlevel_{\max} + RFAtt - Pr eampGain$$

The bandwidth at the IF is 12 MHz. Triggering starts when the trigger threshold is exceeded in a range of 6 MHz around the frequency selected (= start frequency for frequency sweep). This allows spurious emissions, e.g. with pulsed carriers, to be measured, even if the carrier itself is outside the frequency display range.

IEC/IEEE-bus command: TRIG:SOUR RFP
 SWE:EGAT:SOUR RFP

The configuration menu for TV trigger settings can be reached with key sequence *TRIG – NEXT – TV TRIG SETTINGS*:

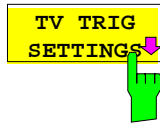

The *TV TRIG SETTINGS* softkey switches the TV trigger on and opens a submenu for configuration of the TV signal parameters.

Note: *Triggering on TV signals is only possible in time domain (span = 0 Hz). Therefore the softkey TV TRIG SETTINGS is without function in frequency domain.*

IEC/IEEE-bus command: `TRIG:SOUR TV`

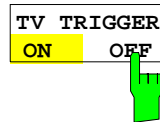

The *TV TRIGGER ON/OFF* softkey switches the TV Trigger on or off. When switching off the TV trigger the selected trigger source will be *FREE RUN*.

IEC/IEEE-bus command: `SENS:TV ON | OFF`

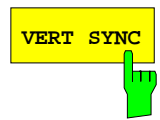

The *VERT SYNC* softkey configures the trigger for the vertical sync signal. The R&S ESCI triggers on the frame repetition without distinction between the two fields.

IEC/IEEE-bus command: `TRIG:VID:FIEL:SEL ALL`



The softkeys *VERT SYNC ODD FIELD* and *VERT SYNC EVEN FIELD* configure the trigger for the vertical sync signal of the first or second field.



IEC/IEEE-bus command: `TRIG:VID:FIEL:SEL EVEN | ODD`

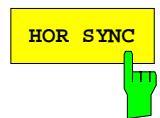

The *HOR SYNC* softkey configures the trigger for the horizontal sync signal and opens the data entry field for selection of the corresponding line.

The trigger can be set on any line number, which can be in the range of 1 to 525 or 1 to 625, depending on the line system. The maximum possible line number will be selected if the active range is exceeded.

In order to trigger on test line 17 according to CCIR 473-4, for example, the line value has to be set to 17. This is the default setting after switching on the TV trigger.

IEC/IEEE-bus command: `TRIG:VID:LINE:NUM 17`



The *VIDEO POL POS / NEG* softkey selects the polarity of the video signal.

Positive video polarity is to be selected e.g. for standard L signals, negative video polarity for signals according to the standards B/G/I/M (colour standard PAL or NTSC). Default setting is *VIDEO POL NEG*.

IEC/IEEE-bus command: `TRIG:VID:SSIG:POL NEG`

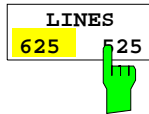

The *LINES 625 / 525* softkey selects the line system currently in use.
Default setting is *625 LINES*.

IEC/IEEE-bus command: `TRIG:VID:FORM:LPFR 625`

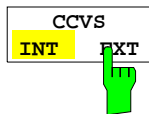

The *CCVS INT / EXT* softkey selects the input channel for the TV trigger input signal. An external CCVS signal can be supplied via the corresponding connector at the rear panel of the instrument.

IEC/IEEE-bus command: `SENS:TV:CCVS INT`

Selection and Setting of Traces – TRACE Key

The R&S ESCI is capable of displaying up to three different traces at a time in a diagram. A trace consists of a maximum of 501 pixels on the horizontal axis (frequency or time). If more measured values than pixels are available, several measured values are combined in one pixel.

The traces are selected using the *SELECT TRACE* softkey in the menu of the *TRACE* key.

The traces can individually be activated for a measurement or frozen after completion of a measurement. Traces that are not activated are blanked.

The display mode can be selected for each trace. Traces can be overwritten in each measurement (CLEAR/WRITE mode), averaged over several measurements (AVERAGE mode), or a maximum or minimum value can be determined from several measurements and displayed (MAX HOLD or MIN HOLD).

Individual detectors can be selected for the various traces. The autopeak detector displays maximum and minimum values connected by a vertical line. The max peak detector and min peak detector display the maximum and minimum value of the level within a pixel. The sample detector displays the instantaneous value of the level at a pixel. The rms detector displays the power (rms value) of the measured values within a pixel, the average detector the average value.

Selection of Trace Function

The trace functions are subdivided as follows:

- Display mode of trace (CLEAR/WRITE, VIEW and BLANK)
- Evaluation of the trace as a whole (AVERAGE, MAX HOLD and MIN HOLD)
- Evaluation of individual pixels of a trace (AUTOPEAK, MAX PEAK, MIN PEAK, SAMPLE, RMS, AVERAGE and QUASIPEAK)

TRACE menu

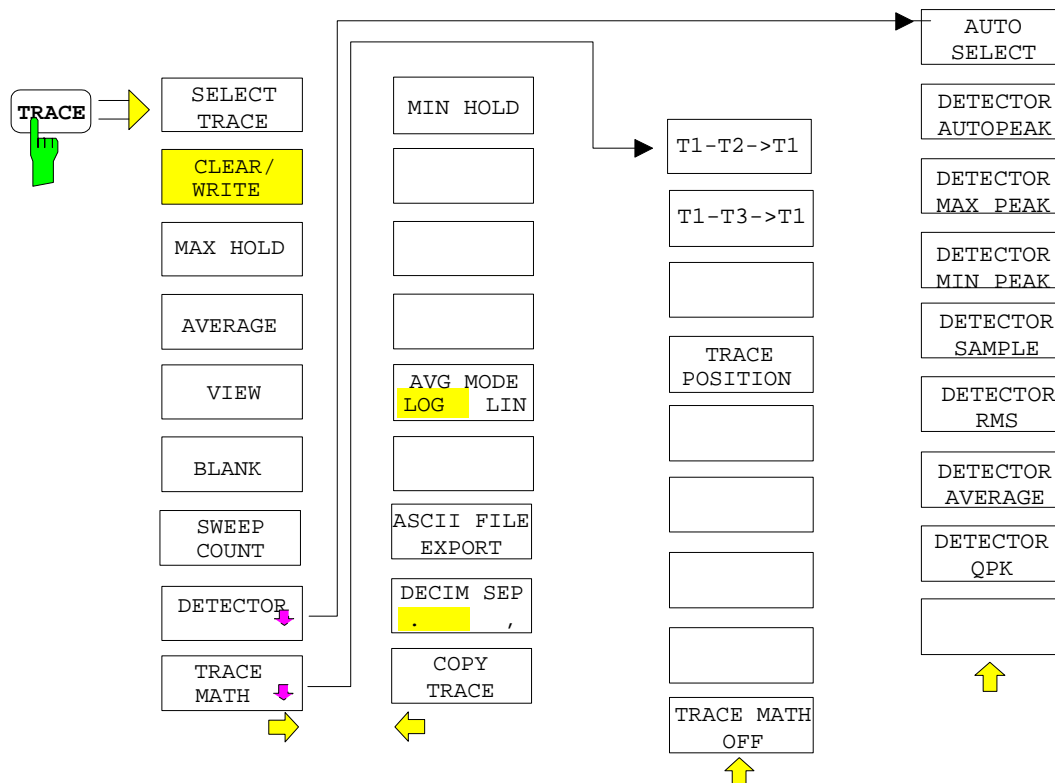

The *TRACE* key opens a menu offering the setting options for the selected trace.

In this menu, the mode of representing the measured data in the frequency or time domain in the 501 pixels of the display is determined. Upon start of the measurement, each trace can be displayed either completely new or based on the previous results.

Traces can be displayed, blanked and copied. Traces can also be corrected with the aid of mathematical functions.

The measurement detector for the individual display modes can be selected directly by the user or set automatically by R&S ESCI.

The default setting is trace 1 in the overwrite mode (*CLEAR / WRITE*), the other traces 2 and 3 are switched off (*BLANK*).

The *CLEAR/WRITE*, *MAX HOLD*, *MIN HOLD*, *AVERAGE*, *VIEW* and *BLANK* softkeys are mutually exclusive selection keys.

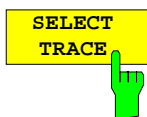

The *SELECT TRACE* softkey activates the entry for the active trace (1, 2, 3).

IEC/IEEE-bus command -- (selected via numeric suffix of :TRACe)

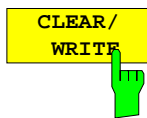

The *CLEAR/WRITE* softkey activates the overwrite mode for the collected measured values, ie the trace is overwritten by each sweep.

In the *CLEAR/WRITE* display mode all the available detectors can be selected. In the default mode the autopeak detector (setting *AUTO*) is selected.

Each time the *CLEAR/WRITE* softkey is actuated, R&S ESCI clears the selected trace memory and starts the measurement anew.

IEC/IEEE-bus command DISP:WIND:TRAC:MODE WRIT

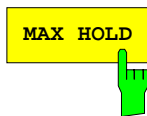

The *MAX HOLD* softkey activates the max peak detector.

R&S ESCI saves the sweep result in the trace memory only if the new value is greater than the previous one.

The detector is automatically set to *MAX PEAK*. The maximum value of a signal can thus be determined over several sweeps.

This is especially useful with modulated or impulsive signals. The signal spectrum is filled up upon each sweep until all signal components are detected in a kind of envelope.

Pressing the *MAX HOLD* softkey again clears the trace memory and restarts the max hold mode.

IEC/IEEE-bus command DISP:WIND:TRAC:MODE MAXH

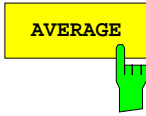

The *AVERAGE* softkey activates the trace averaging function. The average is formed over several sweeps. Averaging can be performed with any of the detectors available. If the detector is automatically selected by R&S ESCI, the sample detector is used.

Depending on the setting of *AVG MODE LOG / LIN*, the logarithmic level values or the measured power/voltage values are averaged.

Averaging is restarted every time the *AVERAGE* softkey is pressed. The trace memory is always cleared.

IEC/IEEE-bus command `DISP:WIND:TRAC:MODE AVER`

Description of averaging

Averaging is carried out over the pixels derived from the measurement samples. Several measured values may be combined in a pixel. This means that with linear level display the average is formed over linear amplitude values and with logarithmic level display over levels. For this reason the trace must be measured again when changing between *LIN* and *LOG* display mode. The settings *CONT/SINGLE SWEEP* and running averaging apply to the average display analogously.

There are two methods for calculating the average. For a sweep count = 0, a running average is calculated according to the following formula:

$$\text{TRACE} = \frac{9 * \text{TRACE} + \text{meas. value}}{10}$$

Due to the weighting between the new measured value and the trace average, past values have practically no influence on the displayed trace after about ten sweeps. With this setting, signal noise is effectively reduced without need for restarting the averaging process after a change of the signal.

If the sweep count is >1, averaging takes place over the selected number of sweeps. In this case the displayed trace is determined during averaging according to the following formula:

$$\text{Trace}_n = \frac{1}{n} \left[\sum_{i=1}^{n-1} (T_i) + \text{meas. value}_n \right]$$

where *n* is the number of the current sweep (*n* = 2 ... *SWEEP COUNT*). No averaging is carried out for the first sweep but the measured value is stored in the trace memory. With increasing *n*, the displayed trace is increasingly smoothed since there are more single sweeps for averaging.

After the selected number of sweeps the average trace is saved in the trace memory. Until this number of sweeps is reached, a preliminary average is displayed.

After completion of averaging, ie when the averaging length defined by *SWEEP COUNT* is attained, a running averaging is continued with *CONTINUOUS SWEEP* according to the following formula:

$$\text{Trace} = \frac{(N-1) \cdot \text{Trace}_{\text{old}} + \text{meas. value}}{N} \quad \text{where} \quad \begin{array}{l} \text{Trace} = \text{new trace} \\ \text{Trace}_{\text{old}} = \text{old trace} \\ N = \text{SWEEP COUNT} \end{array}$$

The display "Sweep N of N" does not change any more until a new start is triggered.

In the *SINGLE SWEEP* mode, the number of sweeps is triggered with *SWEEP START*. The sweeps are stopped when the selected number of sweeps is attained. The number of the current sweep and the total number of sweeps are shown on the display: "Sweep 3 of 200".

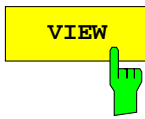

The *VIEW* softkey freezes the current contents of the trace memory and displays it.

If a trace is frozen by *VIEW*, the instrument settings can be changed without the displayed trace being modified (exception: level display range and reference level, see below). The fact that the trace and the current instrument setting do not agree any more is indicated by an enhancement label "*" at the right edge of the grid.

If in the *VIEW* display mode the level display range (*RANGE*) or the reference level (*REF LEVEL*) are changed, R&S ESCI automatically adapts the measured data to the changed display range. This allows an amplitude zoom to be made after the measurement in order to show details of the trace.

IEC/IEEE-bus command `DISP:WIND:TRAC:MODE VIEW`

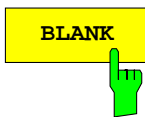

The *BLANK* softkey activates the blanking of the trace on the screen.

IEC/IEEE-bus command `DISP:WIND:TRAC OFF`

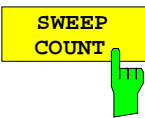

The *SWEEP COUNT* softkey activates the entry of the number of sweeps used for averaging. The allowed range of values is 0 to 30000 and the following should be observed:

- Sweep Count = 0 means running averaging
- Sweep Count = 1 means no averaging being carried out
- Sweep Count > 1 means averaging over the selected number of sweeps; in the continuous sweep mode averaging is performed until the set number of sweeps is attained and is then continued as running averaging.

The default setting is running averaging (Sweep Count = 0). The number of sweeps used for averaging is the same for all active traces in the selected diagram.

Note: *The setting of the sweep count in the trace menu is equivalent to the setting in the sweep menu.*

IEC/IEEE-bus command `SWE:COUN 64`



See following Section "Selection of Detector"



See following Section "Mathematical Functions for Traces"

TRACE - NEXT menu

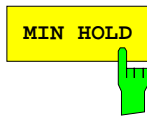

The *MIN HOLD* softkey activates the min peak detector. R&S ESCI saves for each sweep the smallest of the previously stored/currently measured values in the trace memory. The detector is automatically set to *MIN PEAK*. In this way, the minimum value of a signal can be determined over several sweeps.

This function is useful eg for making an unmodulated carrier in a composite signal visible. Noise, interference signals or modulated signals are suppressed by the min hold function whereas a CW signal is recognized by its constant level.

Pressing the *MIN HOLD* softkey again clears the trace memory and restarts the min hold function.

IEC/IEEE-bus command `DISP:WIND:TRAC:MODE MINH`



The *AVG MODE LOG/LIN* softkey selects logarithmic or linear averaging for the logarithmic level display mode.

At the same time the difference calculation is switched between linear and logarithmic in submenu *TRACE MATH*.

IEC/IEEE-bus command `CALC:MATH:AVER:MODE LIN`

With logarithmic averaging, the dB values of the display voltage are averaged or subtracted from each other with trace mathematical functions. With linear averaging the level values in dB are converted into linear voltages or powers prior to averaging. Voltage or power values are averaged or offset against each other and reconverted into level values.

For stationary signals the two methods yield the same result.

Logarithmic averaging bzw. Verrechnung is recommended if sinewave signals are to be clearly visible against noise since with this type of averaging noise suppression is improved while the sinewave signals remain unchanged.

For noise or pseudo-noise signals the positive peak amplitudes are decreased in logarithmic averaging due the characteristic involved and the negative peak values are increased relative to the average value. If the distorted amplitude distribution is averaged, a value is obtained that is smaller than the actual average value. The difference is -2.5 dB.

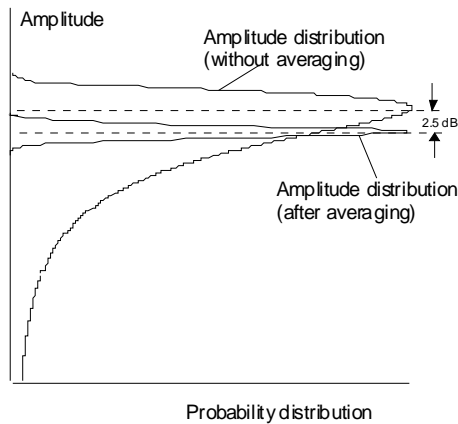

This low average value is usually corrected in noise power measurements by a 2.5 dB factor. Therefore the R&S ESCI offers the selection of linear averaging. The trace data are delogarithmized prior to averaging, then averaged and logarithmized again for display on the screen. The average value is always correctly displayed irrespective of the signal characteristic.

ASCII FILE
EXPORT



The *ASCII FILE EXPORT* softkey stores the active trace in ASCII format on a floppy disk.

```
IEC/IEEE command  FORM ASC;
                   MMEM:STOR:TRAC 1, 'TRACE.DAT'
```

The file consists of the header containing important scaling parameters and a data section containing the trace data.

The data of the file header consist of three columns, each separated by a semicolon:

parameter name; numeric value; basic unit

The data section starts with the keyword " Trace <n> " (<n> = number of stored trace), followed by the measured data in one or several columns (depending on measurement) which are also separated by a semicolon.

This format can be read in from spreadsheet calculation programs, eg MS-Excel. It is necessary to define ';' as a separator.

Note: *Different language versions of evaluation programs may require a different handling of the decimal point. It is therefore possible to select between separators '.' (decimal point) and ',' (comma) using softkey DECIM SEP.*

Example:	
File contents	Description
File header	
Type;ESCI;	Instrument model
Version;1.00;	Firmware version
Date;01.Jul 1999;	Date of data set storage
Mode;Spectrum;	Instrument mode
Center Freq;55000;Hz	Center frequency
Freq Offset;0;Hz	Frequency offset
Span;90000;Hz	Frequency range (0 Hz with zero span and statistics measurements)
x-Axis;LIN;	Scaling of x axis linear (LIN) or logarithmic (LOG)
Start;10000;Hz	Start/stop of the display range.
Stop;100000;Hz	Unit: Hz for span > 0, s for span = 0, dBm/dB for statistics measurements
Ref.Level;-30;dBm	Reference level
Level Offset;0;dB	Level offset
Ref Position;75;%	Position of reference level referred to diagram limits (0% = lower edge)
y-Axis;LOG;	Scaling of y axis linear (LIN) or logarithmic (LOG)
Level Range;100;dB	Display range in in y direction. Unit: dB with x axis LOG, % with x axis LIN
RF Att;20;dB	Input attenuation
RBW;100000;Hz	Resolution bandwidth
VBW;30000;Hz	Video bandwidth
SWT;0.005;s	Sweep time
Trace Mode;AVERAGE;	Display mode of trace: CLR/WRITE,AVERAGE,MAXHOLD,MINHOLD
Detector;SAMPLE;	Detector set: AUTOPEAK,MAXPEAK,MINPEAK,AVERAGE, RMS,SAMPLE,QUASPEAK
Sweep Count;20;	Number of sweeps set
Data section of the file	
Trace 1;;;	Selected trace
x-Unit;Hz;	Unit of x values: Hz with span > 0; s with span = 0; dBm/dB with statistics measurements
y-Unit;dBm;	Unit of y values: dB*/V/A/W depending on the selected unit with y axis LOG or % with y axis LIN
Values; 501;	Number of test points
10000;-10.3;-15.7	Measured values: <x value>, <y1>, <y2>
10180;-11.5;-16.9	<y2> being available only with detector AUTOPEAK and containing in this case the smallest of the two measured values for a test point.
10360;-12.0;-17.4	
...;...;	

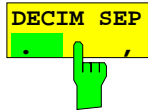

The *DECIM SEP* softkey selects the decimal separator between '.' (decimal point) and ',' (comma) with floating-point numerals for the function ASCII FILE EXPORT.

With the selection of the decimal separator different language versions of evaluation programs (eg MS-Excel) can be supported.

IEC/IEEE-bus command `FORM:DEXP:DSEP POIN`

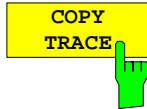

The *COPY TRACE* softkey copies the screen contents of the current trace into another trace memory. The desired memory is selected by entering the number 1, 2 or 3.

Upon copying, the contents of the selected memory is overwritten and the new contents displayed in view mode.

IEC/IEEE-bus command `TRAC:COPY TRACE1,TRACE2`

Selection of Detector

The detectors of the R&S ESCI are implemented as pure digital devices. The detectors available are the peak detectors which determine the maximum and/or the minimum value from a number of samples, the rms detector which measures the power within a pixel, the average, the quasipeak and the sample detector. The sample detector routes through the sampled data without any modification or performs a data reduction by suppressing measured values that cannot be displayed.

The peak detectors compare the current level value with the maximum or minimum level from the previously sampled data. When the number of samples defined by the instrument setting is reached, the samples are combined in displayable pixels. Each of the 501 pixels of the display thus represents 1/501 of the sweep range and contains all single measurements (frequency samples) in this subrange in compressed form. For each trace display mode an optimized detector is selected automatically. Since peak detectors and sample detector are connected in parallel, a single sweep is sufficient for collecting all detector values for 3 traces.

Peak detectors
(*MAX PEAK* and *MIN PEAK*)

Peak detectors are implemented by digital comparators. They determine the largest of all positive (max peak) or the smallest of all negative (min peak) peak values of the levels measured at the individual frequencies which are displayed in one of the 501 pixels. This procedure is repeated for each pixel so that for wide frequency spans and despite the limited resolution of the display a large number of measurements can be taken into consideration for the display of the spectrum.

Autopeak detector

The *AUTOPEAK* detector combines the two peak detectors. The max peak detector and the min peak detector simultaneously determine the maximum and the minimum level within a displayed testpoint and display it as a single measured value. The maximum and minimum levels within a frequency point are connected by a vertical line.

Sample detector

The *SAMPLE* detector routes through the sampled data without any further evaluation and either displays them directly or, for reasons of speed in case of short sweep times, first writes them into a memory and processes them subsequently.

There is no data reduction, ie no summing up of measured values of neighbouring frequencies or time samples. If during a frequency sweep more measured values are obtained than can be displayed, measured values will be lost. This means that discrete signals might be lost.

The sample detector therefore can only be recommended for a span-to-resolution bandwidth ratio of up to approx. 250 in order to ensure that no signal will be suppressed (example: span 1 MHz, - > min. bandwidth 5 kHz).

RMS detector	<p>The RMS detector forms the rms value of the measured values within a pixel.</p> <p>To this effect, R&S ESCI uses the linear voltage after envelope detection. The sampled linear values are squared, summed and the sum is divided by the number of samples (= root mean square). For logarithmic display the logarithm is formed from the square sum. For linear display the root mean square value is displayed. Each pixel thus corresponds to the power of the measured values summed up in the pixel.</p> <p>The rms detector supplies the power of the signal irrespective of the waveform (CW carrier, modulated carrier, white noise or impulsive signal). Correction factors as needed for other detectors for measuring the power of the different signal classes are not required.</p>
Average detector	<p>The average detector forms the average value of the measured values within a pixel.</p> <p>To this effect, R&S ESCI uses the linear voltage after envelope detection. The sampled linear values are summed up and the sum is divided by the number of samples (= linear average value). For logarithmic display the logarithm is formed from the average value. For linear display the average value is displayed. Each pixel thus corresponds to the average of the measured values summed up in the pixel.</p> <p>The average detector supplies the average value of the signal irrespective of the waveform (CW carrier, modulated carrier, white noise or impulsive signal).</p>
Quasipeak detector	<p>The quasipeak detector simulates the behaviour of an analog voltmeter by evaluating the measured values in a pixel.</p> <p>The quasipeak detector is especially designed for the requirements of EMC measurements and is used for evaluating pulse-shaped spurious.</p>

Note: *During a frequency sweep, R&S ESCI increments the 1st local oscillator in steps that are smaller than approximately 1/10 of the bandwidth. This is to ensure that the signal level is correctly measured. For narrow bandwidths and wide frequency spans a very large number of measured values is thus obtained. The number of frequency steps, however, always is a multiple of 501 (= number of pixels that can be displayed). With the sample detector selected, only every n^{th} value is displayed. The value of n depends on the number of measured values, ie on the frequency span, the resolution bandwidth and the measurement rate.*

TRACE-DETECTOR submenu

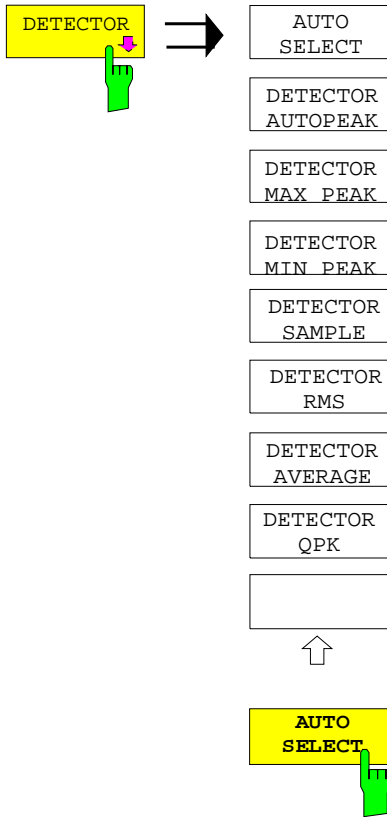

The *DETECTOR* softkey opens a submenu for selecting the detector for the selected trace. The softkey is highlighted if the detector is not selected with *AUTO SELECT*.

The detector can be selected independently for each trace. The *AUTO SELECT* mode selects the optimum detector for each display mode of the trace (Clear/Write, Max Hold or Min Hold).

The softkeys for the detectors are mutually exclusive selection keys.

The *AUTO SELECT* softkey (= default setting) selects the optimum detector for the set display mode of the trace (Clear/Write, Max Hold and Min Hold) and the selected filter mode (bandpass/FFT).

Trace display	Detector (bandpass)	Detector (FFT)
Clear/Write	Auto Peak	Max Peak
Average	Sample	Sample
Max Hold	Max Peak	Max Peak
Min Hold	Min Peak	Max Peak

The detector activated for the specific trace is identified in the respective trace display field as follows:

Detector	
Auto Peak	AP
Max Peak	PK
Min Peak	MI
Average	AV
RMS	RM
Sample	SA
Quasipeak	QP

IEC/IEEE-bus command DET:AUTO ON

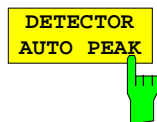

The *DETECTOR AUTOPEAK* softkey activates the autopeak detector.

IEC/IEEE-bus command DET APE

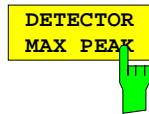

The *DETECTOR MAX PEAK* softkey activates the max peak detector. It is recommended for measurement of impulsive signals.

IEC/IEEE-bus command DET POS

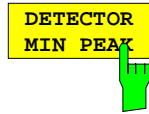

The *DETECTOR MIN PEAK* softkey activates the min peak detector. Weak sinewave signals become clearly visible in noise using this detector. In case of a composite signal made up of sinewave and impulsive signals, the impulsive signals are suppressed.

IEC/IEEE-bus command DET NEG

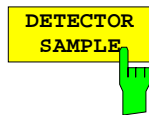

The *DETECTOR SAMPLE* softkey activates the sample detector.

It is used for measuring uncorrelated signals such as noise. The power can be determined with the aid of fixed correction factors for evaluation and the logarithmic function.

IEC/IEEE-bus command DET SAMP

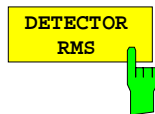

The *DETECTOR RMS* softkey activates the rms detector.

The rms detector supplies the power of the signal independent of the waveform. For this effect the root mean square of all sampled level values is formed during the sweep of a pixel. The sweep time thus determines the number of averaged values and with increasing sweep time better averaging is obtained. The rms detector is thus an alternative for averaging over several sweeps (see TRACE AVERAGE).

Since the video bandwidth must be at least 10 times the resolution bandwidth (RBW) to ensure that video filtering does not invalidate the rms values of the signal, this ratio is set automatically upon activating the detector.

IEC/IEEE-bus command DET RMS

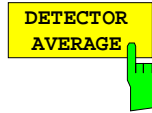

The *DETECTOR AVERAGE* softkey activates the average detector.

In contrast to the rms detector, the average detector supplies the linear average of all sampled level values during the sweep of a pixel.

The same relations as for the rms detector apply (see above).

IEC/IEEE-bus command DET AVER

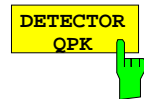

The *DETECTOR QPK* softkey activates the quasipeak detector.

This detector evaluates the sampled level values during the sweep of a pixel like an analog voltmeter.

On switching the quasipeak detector on the video bandwidth is automatically set to 10 MHz so as to exclude the influence of the video filter on the signal evaluation.

IEC/IEEE-bus command DET QPE

Mathematical Functions for Traces

TRACE 1-TRACE MATH submenu:

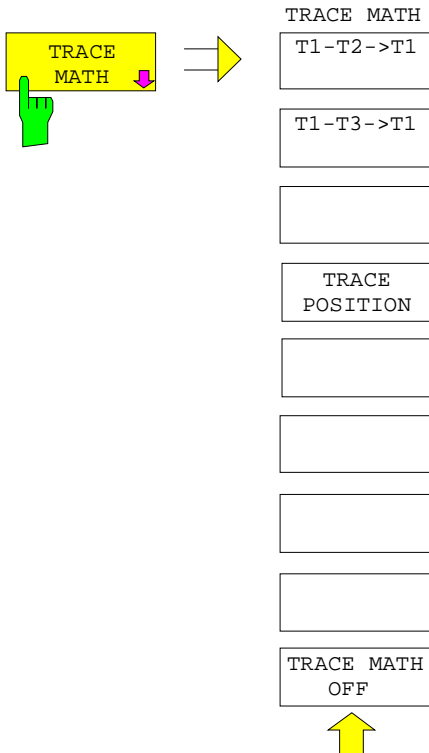

The *TRACE MATH* softkey opens a submenu in which the difference between the selected trace to trace 1 is calculated. The softkey is highlighted if a math function is activated.

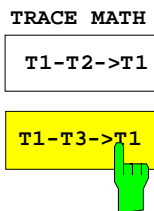

The *T1-T2* and *T1-T3* softkeys subtract the corresponding traces. The result displayed is referred to the zero point defined by *TRACE POSITION*.

To indicate that the trace has been obtained by subtraction, the difference "1 - 2" or "1 - 3" is indicated on the trace info of trace 1 and in the *TRACE* main menu the *TRACE MATH* softkey is highlighted.

IEC/IEEE-bus command `CALC:MATH (TRACE1-TRACE2)`
`CALC:MATH (TRACE1-TRACE3)`



The *TRACE POSITION* softkey activates the entry of the trace position for 0 difference. The position is stated in % of the diagram height. The range of values extends from -100% to +200%

IEC/IEEE-bus command `DISP:MATH:POS 50PCT`

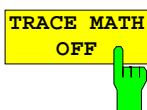

The *TRACE MATH OFF* softkey switches the math function off.

IEC/IEEE-bus command `CALC:MATH:STAT OFF`

Recording the Correction Data of R&S ESCI – CAL Key

The R&S ESCI obtains its high measurement accuracy through its inbuilt self-alignment method.

The correction data and characteristics required for the alignment are determined by comparison of the results at different settings with the known characteristics of the high-precision calibration signal source of R&S ESCI at 128 MHz. The correction data are then available in the instrument as a file and can be displayed by means of the *CAL RESULTS* softkey.

For service purposes the use of correction data can be deactivated by means of the *CAL CORR ON/OFF* softkey. If the correction data recording is aborted, the last complete correction data set is restored.

Note: *The term "Calibration" formerly used for the integrated self alignment was often mistaken for the "true" calibration of the instrument at the test set in production and in service. It is therefore no longer used although it appears in the abbreviated form in the name of keys ("CAL...").*

CAL menu:

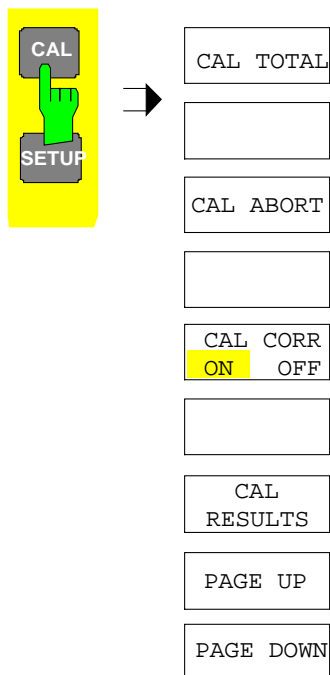

The *CAL* key opens a menu with the available functions for recording, displaying and activating the data for self alignment.



The *CAL TOTAL* softkey starts the recording of correction data of the instrument.

If the correction data recording has failed or if the correction values are deactivated (*CAL CORR = OFF* softkey), the status field indicates

UNCAL

IEC/IEEE-bus command: *CAL?



The *CAL ABORT* softkey interrupts the recording of correction data and restores the last complete correction data set.

IEC/IEEE-bus command: CAL:ABOR

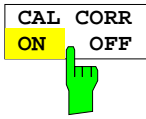

The *CAL CORR ON/OFF* softkey switches the calibration data on/off.

ON The status message depends upon the results of the total calibration.

OFF The message *UNCAL* appears in the status line.

IEC/IEEE-bus command: CAL:STAT ON



The *CAL RESULTS* softkey calls the *CALIBRATION RESULTS* table, which shows the correction data found during calibration.

The *CALIBRATION RESULTS* table contains the following information:

- date and time of last record of correction values Korrekturwertaufnahme
- overall results of correction value record
- list of found correction values according to function/module

The results have the following meaning:

- PASSED calibration successful without any restrictions
- CHECK deviation of correction value larger than expected, correction could however be performed
- FAILED deviations of correction value too large, no correction was possible. The found correction data are not valid.
- ABORTED calibration aborted

CALIBRATION RESULTS			
Total Calibration Status: PASSED			
Rohde&Schwarz,ESCI-3,101450/007,3.32c			
Date (dd/mm/yyyy): 08/03/2004 Time: 06:06:06			
Runtime: 03:03			
Linear detector offset [%]			
			1.51
LC center frequencies			
LC-cycle	DAC [%]	Error[kHz]	
1	44.28	-2.00	PASSED
2	45.45	2.00	PASSED
3	44.49	0.00	PASSED
4	45.27	2.00	PASSED
Bandwidths and center frequency offsets			
RBW	DAC [%]	E [RBW %]	
300 kHz 3 dB CenterFreq	47.65	0.60	PASSED

IEC/IEEE-bus command: CAL:RES?

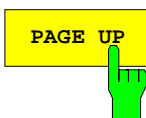

The softkeys *PAGE UP* and *PAGE DOWN* scroll one page forward or backward in the *CALIBRATION RESULTS* table. They have no function when the table is closed.

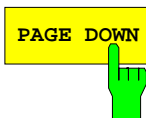

IEC/IEEE-bus command: --

Markers and Delta Markers – MKR Key

The markers are used for marking points on traces, reading out measurement results and for quickly selecting a display section. R&S ESCI provides four markers per display window. All markers can be used either as markers or delta markers. The availability of marker functions depends on whether the measurement is performed in the frequency, time or level domain.

The marker that can be moved by the user is defined in the following as the **active marker**.

Examples of marker display:

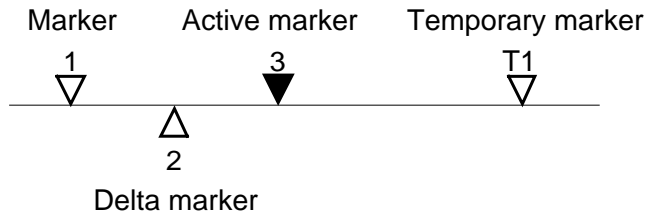

Temporary markers are used in addition to the markers and delta markers to evaluate the measurement results. They disappear when the associated function is deactivated.

The measurement results of the active marker (also called **marker values**) are displayed in the marker field. The marker info field at the upper right of the display shows the marker location (here, frequency), the level and the currently selected trace [T1].

```

MARKER 1 [T1]
-27.5 dBm
123.4567 MHz
  
```

The *MKR* key calls a menu that contains all marker and delta marker standard functions. If no marker is active, *MARKER 1* will be enabled and a peak search on the trace carried out. Otherwise, the data entry for the marker activated last is opened.

MKR menu:

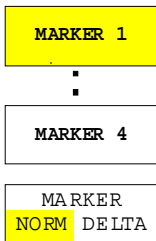
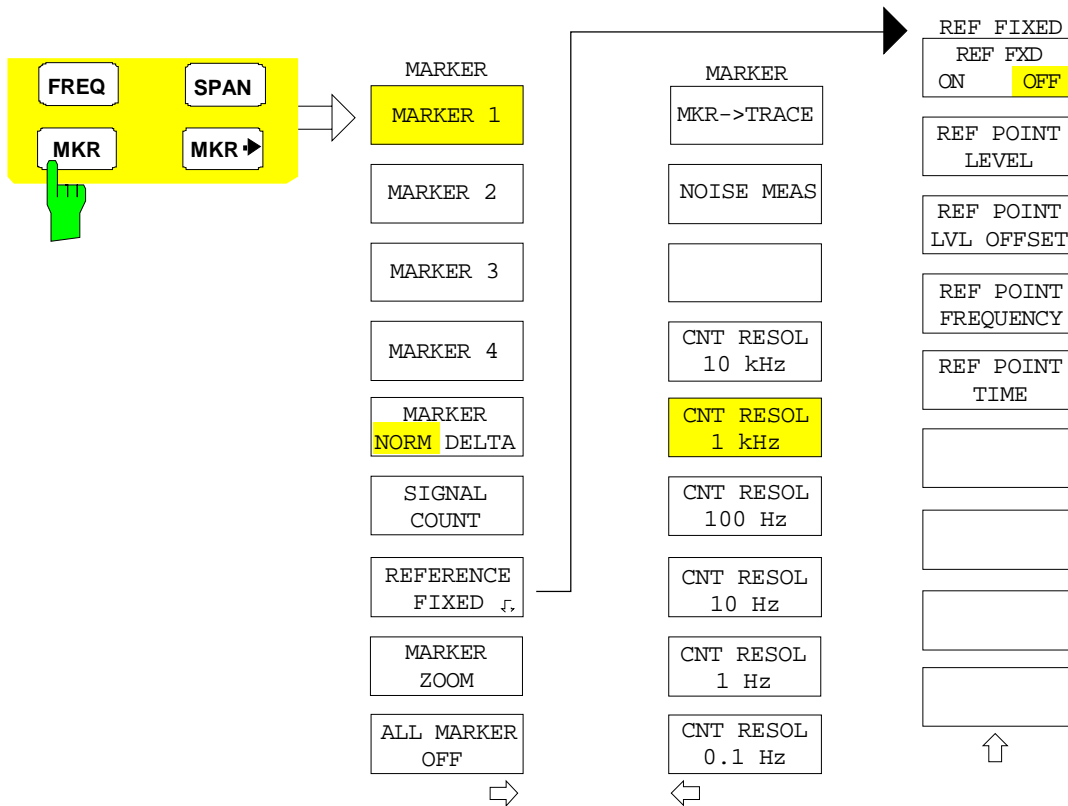

The *MARKER 1/2/3/4* .softkey selects the corresponding marker and activates it.

MARKER 1 is always the normal marker. After they have been switched on, *MARKERS 2 to 4* are delta markers that refer to *MARKER 1*. These markers can be converted into markers with absolute value display by means of the *MARKER NORM DELTA* softkey. When *MARKER 1* is the active marker, pressing the *MARKER NORM DELTA* softkey switches on an additional delta marker.

Pressing the *MARKER 1 to 4* softkey again switches off the selected marker.

Example:

- [PRESET] R&S ESCI is set to the default setting.
- [MKR] On calling the menu, *MARKER 1* is switched on ('1' highlighted in the softkey) and positioned on the maximum value of the trace. It is a normal marker and the *MARKER NORMAL* softkey is highlighted.
- [MARKER 2] *MARKER 2* is switched on ('2' highlighted in the softkey). It is automatically defined as a delta marker on switching on so the *DELTA* is highlighted on softkey *MARKER NORM DELTA*. The frequency and level of *MARKER 2* with reference to *MARKER 1* are output in the marker info field.
- [MARKER NORM DELTA] The *MARKER NORM DELTA* softkey is highlighted. *MARKER 2* becomes a normal marker. The frequency and level of *MARKER 2* are output as absolute values in the marker info field.
- [MARKER 2] *MARKER 2* is switched off. *MARKER 1* is the active marker for entry. The frequency and level of *MARKER 1* are output in the marker info field.

IEC/IEEE-bus command:

```

CALC:MARK ON;
CALC:MARK:X <value>;
CALC:MARK:Y?

CALC:DELT ON;
CALC:DELT:MODE ABS|REL
CALC:DELT:X <value>;
CALC:DELT:X:REL?
CALC:DELT:Y?

```

When several traces are being displayed, the marker is set to the maximum value (peak) of the active trace which has the lowest number (1 to 3). In case a marker is already located there, it will be set to the frequency of the next lowest level (next peak).

When the split-screen display mode is active, the marker will be placed in the active window. A marker can only be enabled when at least one trace in the corresponding window is visible.

If a trace is turned off, the corresponding markers and marker functions are also deactivated. If the trace is switched on again (*VIEW, CLR/WRITE;..*), the markers along with coupled functions will be restored to their original positions provided the markers have not been used on another trace.



The *MKR*→*TRACE* softkey places the marker on a new trace. The trace is selected via a data entry field. Only those traces can be selected which are visible on the screen in the same window.

Example:

Three traces are presented on the screen. The marker is always on Trace 1 on switching on.

[*MKR* ->*TRACE*]
"2"

The marker jumps to Trace 2 but remains on the previous frequency or time.

[*MKR* ->*TRACE*]
"3"

The marker jumps to Trace 3. '

IEC/IEEE-bus command: *CALC:MARK1:TRAC 1*
 CALC:DELT:TRAC 1

Frequency Measurement with the Frequency Counter

In order to accurately determine the frequency of a signal, R&S ESCI is equipped with a frequency counter which measures the frequency of the RF signal at the intermediate frequency. Using the measured IF, R&S ESCI calculates the frequency of the RF input signal by applying the known frequency conversion factors.

The frequency measurement error depends only upon the accuracy of the frequency standard used (external or internal reference). Although R&S ESCI always operates synchronously irrespective of the set span, the frequency counter delivers a more exact result than a measurement performed with a marker. This is due to the following:

- The marker measures only the position of the pixel on the trace and infers the frequency of the signal from this value. The trace, however, contains only a limited number of pixels. Depending upon the selected span, each pixel may contain many measurement values, which therefore limits the frequency resolution.
- The resolution with which the frequency can be measured is proportional to the measurement time. For this reason, the bandwidth is normally made as wide as possible and the sweep time as short as possible. This results in a loss of frequency resolution.

For the measurement with the frequency counter, the sweep is stopped at the reference marker, the frequency is counted with the desired resolution and then the sweep is allowed to continue.

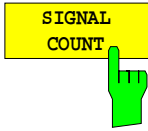

The *SIGNAL COUNT* softkey switches the frequency counter on/off.

The frequency is counted at the position of the reference marker (*MARKER 1*). The sweep stops at the reference marker until the frequency counter has delivered a result. The time required for a frequency measurement depends on the selected frequency resolution. The resolution is set in the side menu.

If no marker is enabled when the *SIGNAL COUNT* softkey is pressed, *MARKER 1* is switched on and set at the largest signal.

In addition, the *SIGNAL COUNT* function is displayed in the marker info field on the screen with [Tx CNT].

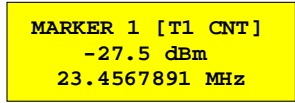

Switching the *SIGNAL COUNT* function off is accomplished by pressing the softkey again.

IEC/IEEE-bus command: `CALC:MARK1:COUN ON;`
 `CALC:MARK:COUN:FREQ?`

MARKER NEXT menu

The resolution of the frequency counter is set in the *NEXT* menu of the *MARKER* menu. R&S ESCI offers counter resolutions between 0.1 Hz and 10 kHz.

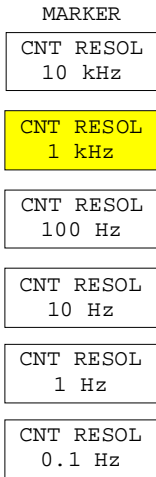

The *CNT RESOL ...* softkeys select the counter resolution. They are selection switches, i.e. only one of the can be active at any one time. The marker stop time, ie the frequency measurement time, depends on the selected resolution.

IEC/IEEE-bus command: `CALC:MARK1:COUN:RES <value>`

Measurement example:

The frequency of a CW signal is to be determined by means of the frequency counter with a resolution of 10 Hz.

[PRESET] R&S ESCI is set to the default setting.

[MARKER] *MARKER 1* is switched on and set to the maximum value of the displayed spectrum.

[SIGNAL COUNT] The frequency counter is switched on. R&S ESCI counts the frequency of the signal at the marker position with a resolution of 1 kHz. The counted frequency is indicated in the marker info field.

[NEXT] Changes to the submenu for setting the counter resolution.

[CNT RESOL 10 Hz] The frequency counter resolution is increased to 10 Hz.

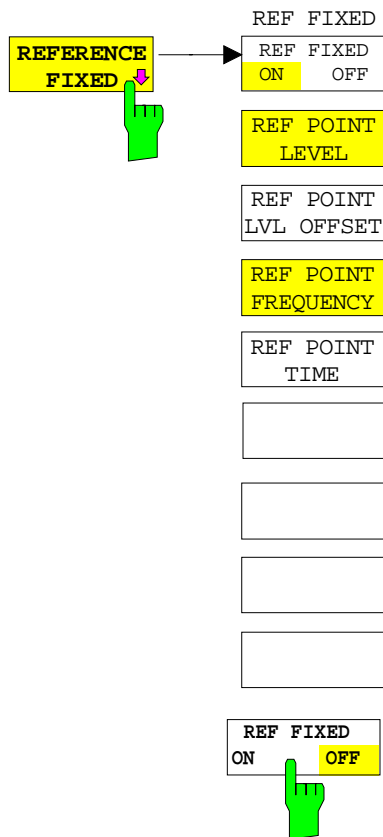

The *REFERENCE FIXED* softkey defines the level and the frequency or time of *MARKER 1* as a reference for one or several delta markers. The measured values for one or several markers displayed in the marker info field are derived from this reference point instead of the current values of the reference marker (*MARKER 1*).

On actuating the softkey, reference fixed is switched on and thus, the level value and the frequency, time or x-level value of *MARKER 1* immediately become the reference point.

Additionally, the *REFERENCE FIXED* softkey opens the sub-menu where it is possible to determine manually a reference point with level and frequency, time or x-axis level, to define a level offset or deactivate the reference point.

The *REFERENCE FIXED* function is useful for the measurement of the harmonic suppression at small span (fundamental not represented).

The *REF FXD ON/OFF* softkey switches on or off the relative measurement to a fixed reference value (*REFERENCE POINT*) independent of the trace.

IEC/IEEE-bus command: `CALC:DELT2:FUNC:FIX ON`



The *REF POINT LEVEL* softkey enters a reference level independent of the reference marker level. All relative level values of the delta markers refer to this reference level.

IEC/IEEE-bus command:

`CALC:DELT2:FUNC:FIX:RPO:Y -10dBm`



The *REF POINT LVL OFFSET* softkey specifies a level offset relevant to the reference level. The relative level values of the delta markers refer to the reference point level plus the level offset.

The level offset is set to 0 dB on enabling the *REFERENCE FIXED* or *PHASE NOISE* function.

IEC/IEEE-bus command:

`CALC:DELT2:FUNC:FIX:RPO:Y:OFFS 0dB`



With the *REF POINT FREQUENCY* softkey a reference frequency can be manually activated for the delta markers when the *REFERENCE FIXED* or *PHASE NOISE* function is used.

IEC/IEEE-bus command:

`CALC:DELT2:FUNC:FIX:RPO:X 10.7MHz`

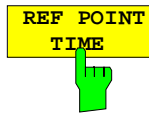

The *REF POINT TIME* softkey activates the entry box for the input of a reference time for the *REFERENCE FIXED* function in the time domain (span = 0 Hz).

IEC/IEEE-bus command:

```
CALC:DELT2:FUNC:FIX:RPO:X 5MS
```

For phase noise measurement, input of reference time is not possible.

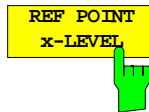

The *REF POINT x-LEVEL* softkey activates the entry box for the input of a reference level on the x-axis for the *REFERENCE FIXED* function when the power sweep is active.

IEC/IEEE-bus command:

```
CALC:DELT2:FUNC:FIX:RPO:X -5DBM
```

Measurement example:

Small-span harmonics measurement to increase sensitivity
CW signal (eg 100 MHz, 0 dBm) with harmonics at the RF input of R&S ESCI.

[PRESET]	R&S ESCI is set to the default setting.
[CENTER: 100 MHz]	The center frequency of R&S ESCI is set to 100 MHz.
[SPAN: 1 MHz]	The span is set to 1 MHz.
[AMPL: 3 dBm]	The reference level is set to 3 dBm (3 dB above the expected RF level).
[MKR]	<i>MARKER 1</i> is switched on ('1' highlighted in the softkey) and set to the signal peak.
[MARKER 2]	<i>MARKER 2</i> is switched on and automatically defined as the delta marker (<i>DELTA</i> is highlighted on <i>MARKER NORM DELTA</i> softkey).
[REFERENCE FIXED]	The frequency and level of <i>MARKER 1</i> are a reference for the delta marker.
[CENTER: 200 MHz]	The center frequency is set to 200 MHz (= frequency of the 2nd harmonic). The reference level may have to be reduced to see the 2nd harmonic from the noise. This does not affect the reference level set with <i>REFERENCE FIXED</i> .
[MKR->: PEAK]	The delta marker jumps to the 2nd harmonic of the signal. The level spacing of the harmonic to the fundamental is displayed in the marker info field.

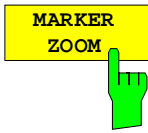

The *MARKER ZOOM* softkey expands the area around *MARKER 1*. With the zoom function, more details of the spectrum can be seen. The desired display range can be defined in an entry window.

The following sweep is stopped at the position of the reference marker. The frequency of the signal is counted and the measured frequency becomes the new center frequency. The zoomed display range is then configured and the new settings are used by R&S ESCI for further measurements.

As long as switching to the new frequency display range has not yet taken place, pressing the softkey will abort the procedure.

If *MARKER 1* is not active when the softkey is pressed, it is automatically activated and set to the highest peak in the window.

If an instrument setting is changed after selection of *MARKER ZOOM*, the function is aborted.

The *MARKER ZOOM* softkey is only available in the frequency domain (span > 0).

IEC/IEEE-bus command: `CALC:MARK1:FUNC:ZOOM 1kHz`



The *ALL MARKER OFF* softkey switches off all markers (reference and delta markers). It also switches off all functions and displays associated with the markers/delta markers.

IEC/IEEE-bus command: `CALC:MARK:AOFF`

Marker Functions – MKR FCTN Key

The MKR FCTN menu offers further measurements with the markers:

- Measurement of noise density (*NOISE MEAS* softkey)
- Measurement of phase noise (*PHASE NOISE* softkey)
- Measurement of filter or signal bandwidth (*N DB DOWN* softkey)
- Activating of AF demodulation (*MARKER DEMOD* softkey)

On calling the menu, the entry for the last active marker is activated (*SELECT MARKER* softkey); if no marker is activated, marker 1 is activated and a maximum search (*PEAK* softkey) is performed. The marker can be set to the desired trace by means of *MKR -> TRACE* softkey.

Menu *MKR FCTN*:

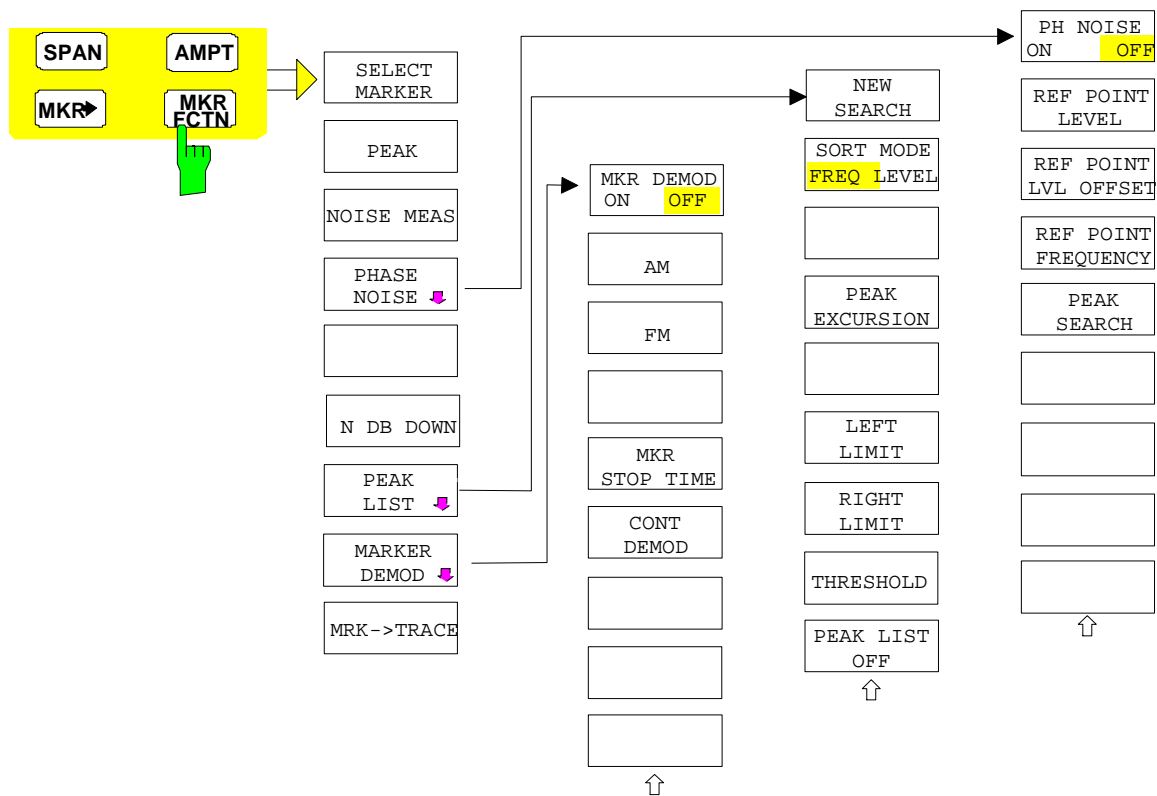

Activating the Markers

Menu *MKR FCTN*:

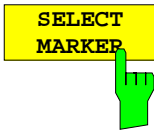

The *SELECT MARKER* softkey activates the numerical selection of the marker in the data entry field. Delta marker 1 is selected by input of '0'. If the marker is switched off, then it is switched on and can be moved later on.

IEC/IEEE-bus command: `CALC:MARK1 ON;`
`CALC:MARK1:X <value>;`
`CALC:MARK1:Y?`

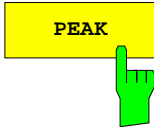

The *PEAK* softkey sets the active marker/delta marker to the peak of the trace.

IEC/IEEE-bus command: `CALC:MARK1:MAX`
`CALC:DELT1:MAX`

Measurement of Noise Density

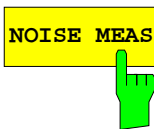

The *NOISE MEAS* softkey switches the noise measurement for the active marker on or off. The corresponding marker becomes the *NORMAL* marker.

During noise measurement, the noise power density is measured at the position of the marker. In the time domain mode, all points of the trace are used to determine the noise power density. When measurements are performed in the frequency domain, two points to the right and left of the marker are used for the measurement to obtain a stable result.

The noise power density is indicated in the marker field. With a logarithmic amplitude units (dBm, dBmV, dBm μ V, dB μ A) the noise power density is output in dBm/Hz i.e. as level in 1 Hz bandwidth with reference to 1 mW. With linear amplitude units (V, A, W) the noise voltage density is evaluated in μ V/ \sqrt Hz, the noise current density in μ A/ \sqrt Hz or the noise power density in μ W/Hz.

The following settings have to be made to ensure that the power density measurement yields correct values:

Detector: Sample or RMS

Video bandwidth:

- ≤ 0.1 x resolution bandwidth with sample detector
(corresponds to RBW / VBW NOISE)
- ≥ 3 x resolution bandwidth with RMS detector
(corresponds to RBW / VBW SINE)

In the default setting, the R&S ESCI uses the sample detector for the noise function.

With the sample detector, the trace can additionally be set to AVERAGE to stabilize the measured values. With RMS detector used, trace averaging must not be used since in this case it produces too low noise levels which cannot be corrected. Instead, the sweep time can be increased to obtain stable measurement results.

The R&S ESCI uses the following correction factors to evaluate the noise density from the marker level:

- Since the noise power is indicated with reference to 1 Hz bandwidth, the bandwidth correction value is deducted from the marker level. It is $10 \times \lg(1 \text{ Hz}/\text{BW}_{\text{Noise}})$, where BW_{Noise} is the noise or power bandwidth of the set resolution filter (RBW).

Sample detector:

- As a result of video filter averaging and trace averaging, 1.05 dB is added to the marker level. This is the difference between the average value and the RMS value of white noise.
- With a logarithmic level axis, 1.45 dB is added additionally. Logarithmic averaging is thus fully taken into account which yields a value that is 1.45 dB lower than that of linear averaging.

RMS detector:

- With the exception of bandwidth correction, no further corrections are required for the RMS detector since it already indicates the power with every point of the trace.

To allow a more stable noise display the adjacent (symmetric to the measurement frequency) points of the trace are averaged.

In time domain mode, the measured values are averaged versus time (after a sweep).

IEC/IEEE-bus command: `CALC:MARK:FUNC:NOIS ON;`
 `CALC:MARK:FUNC:NOIS:RES?`

Example: Measurement of inherent R&S ESCI noise

- [PRESET]** The R&S ESCI is set to default setting.
- [MARKER]** Marker 1 is switched on and set to the maximum value of the displayed spectrum. Set marker to desired frequency using the rotary knob.
- [NOISE]** The R&S ESCI switches the sample detector on and sets the video bandwidth to 300 kHz (0.1 x RBW). The power density level of inherent noise is displayed in dBm/Hz in the marker info field.

Note: *The R&S ESCI noise figure can be calculated from the measured power density level. It is calculated by deducting the set RF attenuation (RF Att) from the displayed noise level. 174 is to be added to the result to obtain the R&S ESCI noise figure.*

Phase Noise Measurement

Menu MKR FCTN:

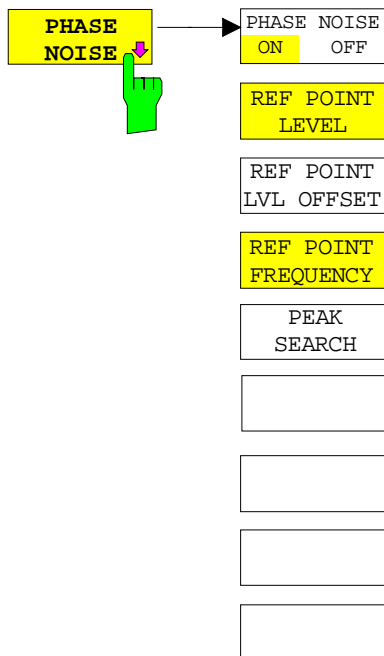

The *PHASE NOISE* softkey switches the *PHASE NOISE* function on/off. Additionally, the softkey opens the submenu for manually setting the reference point. The phase noise measurement can be switched off in the submenu.

MARKER 1 (= reference marker) is used as a reference for the phase noise measurement. The frequency and level of the reference marker are used as fixed reference values, i.e. the *REFERENCE FIXED* function is activated. After switching on the phase noise measurement the reference level or the center frequency can thus be set in a way that the carrier is outside the displayed frequency range, or, for example, a notch filter is switched on to suppress the carrier.

A noise power density measurement is carried out with the delta marker or delta markers. This measurement corresponds to the *NOISE* function in the *MARKER* menu (MKR). The result of the phase noise measurement is the difference in level between the reference point and the noise power density.

The following possibilities can be selected on switching on *PHASE NOISE*:

1. No marker enabled:

[MKR FCTN] *MARKER 1* is enabled and set to peak.
 [PHASE NOISE] *MARKER 1* becomes the reference marker, *MARKER 2* the delta marker; frequency = frequency of the reference marker. The delta marker is the active marker, i.e. it can be moved with the rollkey or adjusted by entering numerals. The *PHASE NOISE* function is switched on and the measured value is output.

2. Markers are enabled:

[MKR FCTN] The previous marker configuration remains unchanged.
 [PHASE NOISE] *MARKER 1* becomes the reference marker. If other markers are enabled, they become delta markers and measure the phase noise at their respective positions.

If further markers are enabled during the phase noise measurement, they automatically become delta markers and measure the phase noise at their respective positions.

When the phase noise measurement is switched off, the marker configuration remains unchanged and the delta markers measure the relative level to the reference marker (*MARKER 1*).

The *PHASE NOISE* function measures the noise power at the delta markers referred to 1 Hz bandwidth. The sample detector is automatically used and the video bandwidth set to 0.1 times the resolution bandwidth (RBW). The two settings are taken into account in the correction values used for the noise power measurement.

To obtain stable results, two pixels on the right and the left of the respective delta marker position are taken for the measurement. The procedure for determining the noise power is identical to the method used for the noise power measurement (see *NOISE* softkey). The measured noise level referred to 1 Hz bandwidth is subtracted from the carrier level at the reference marker (*MARKER 1*). The measured values are displayed in the delta marker field in dBc/Hz (= spacing in dB of the noise power from the carrier level in 1 Hz bandwidth).

If several delta markers are enabled, only the value read by the active marker is shown in the marker field. If several delta markers are active, their measurement results are shown in the marker info field.

The reference value for the phase noise measurement can be defined with *REF POINT LEVEL*, *REF POINT FREQUENCY* and *REF POINT LVL OFFSET* to differ from that of the reference marker.

IEC/IEEE-bus command: --

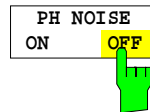

The *PH NOISE ON/OFF* softkey switches on/off the phase noise measurement. Switching on is performed by means of the *PHASE NOISE* softkey and is only necessary when the phase noise measurement has been switched off in the submenu.

IEC/IEEE-bus command: `CALC:DELT1:FUNC:PNO ON`
`CALC:DELT1:FUNC:PNO:RES?`



The *REF POINT LEVEL* softkey activates an entry box for the input of a reference level other than the reference marker level. The function is identical to that of the softkey with the same name in the marker menu (*MKR*).

IEC/IEEE-bus command: `CALC:DELT1:FUNC:FIX:RPO:Y -10dB`



The *REF POINT LVL OFFSET* softkey activates an entry box for the input of an additional level offset for the phase noise calculation.

This level offset is set to 0 dB on when the *REFERENCE FIXED* or *PHASE NOISE* function is enabled.

IEC/IEEE-bus command: `CALC:DELT:FUNC:FIX:RPO:Y:OFFS 10dB`

REF POINT
FREQUENCY

The *REF POINT FREQUENCY* softkey activates an entry box for the manual input of a reference frequency for the *REFERENCE FIXED* or *PHASE NOISE* function.

IEC/IEEE-bus command:

CALC:DELT1:FUNC:FIX:RPO:X 10.7MHz

PEAK
SEARCH

The *PEAK SEARCH* sets the reference point level for delta marker 2 in the selected measurement window to the peak of the selected trace.

IEC/IEEE-bus command: CALC:DELT:FUNC:FIX:RPO:MAX

Measurement example:

The phase noise of a CW signal at 100 MHz with 0 dBm level is to be measured at 800 kHz from the carrier

[PRESET]	The R&S ESCI is set to the default setting.
[CENTER: 100 MHz]	The center frequency is set to 100 MHz.
[SPAN: 2 MHz]	The span is set to 2 MHz.
[AMPT: 0 dBm]	The reference level is set to 0 dBm.
[MKR FCTN]	<i>MARKER 1</i> is switched on and positioned at the maximum of the displayed trace.
[PHASE NOISE: 800 kHz]	The phase noise measurement is switched on. The delta marker is positioned on the main marker and the measured phase noise value is displayed in the marker info field. The sample detector is used and the video bandwidth is set to 3 x RBW. When the phase noise measurement function is enabled, the entry of the delta marker frequency is activated. It can be entered directly.

Measurement of the Filter or Signal Bandwidth

Menu *MKR FCTN*:

N dB DOWN



The *N dB DOWN* softkey activates the temporary markers T1 and T2 which are n dB below the active reference marker. Marker T1 is placed to the left and marker T2 at the right of the reference marker. The value n can be input in a window.

The default setting is 3 dB.

The frequency spacing of the two temporary markers is indicated in the marker info field.

If, for example, it is not possible to form the frequency spacing for the n dB value because of the noise display, dashes are indicated instead of a measured value.

IEC/IEEE-bus command: CALC:MARK1:FUNC:NDBD:STAT ON
CALC:MARK1:FUNC:NDBD 3dB
CALC:MARK1:FUNC:NDBD:RES?
CALC:MARK1:FUNC:NDBD:FREQ?

Measurement of a Peak List

Menu *MKR FCTN*:

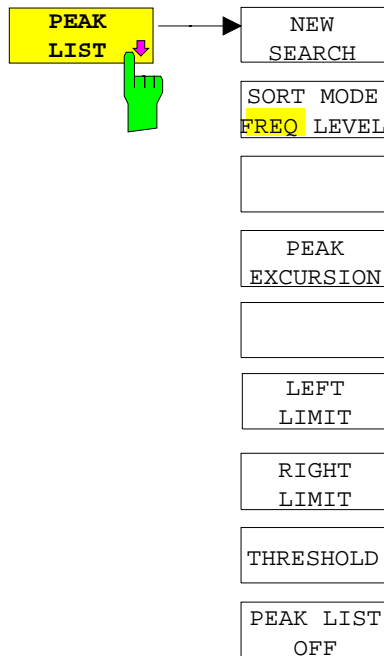

The *PEAK LIST* softkey allows the peak values of the trace to be determined and entered in a list with 50 entries max. The order of the entries is defined by the *SORT MODE*:

FREQ sorting in ascending order of frequency values (see screenshot); if span = 0, the entries are sorted in ascending order of time values

LEVEL sorting according to level

PEAK LIST		
#	FREQUENCY	POWER
1	794.871794871 MHz	-55.37 dBm
2	2.397435897 GHz	-74.70 dBm
3	4.012620512 GHz	-38.00 dBm
4	5.615384615 GHz	-26.04 dBm
5	6.435897435 GHz	-38.02 dBm
6	7.217948717 GHz	-55.39 dBm

The search range can be restricted by means of the *LEFT LIMIT*, *RIGHT LIMIT* and *THRESHOLD* softkeys. The definition of the peak values can be modified using the *PEAK EXCURSION* softkey. The *MKR->TRACE* softkey in the main menu is used to select the trace for searching peak values.

Opening the list performs a single search at the end of the sweep. The *NEW SEARCH* softkey triggers a new sweep, determines the peak values of the trace at the end of the sweep and enters them in the list.

Use the *PEAK LIST OFF* key to delete the list from the screen.

```
IEC/IEEE-bus commands: INIT:CONT OFF;
                        CALC:MARK:TRAC 1;
                        CALC:MARK:FUNC:FPE:SORT X;
                        INIT;*WAI;
                        CALC:MARK:FUNC:FPE 10;
                        CALC:MARK:FUNC:FPE:COUN?;
                        CALC:MARK:FUNC:FPE:Y?;
                        CALC:MARK:FUNC:FPE:X?
```



The *NEW SEARCH* softkey starts a new peak search and enters the results in the peak list.

IEC/IEEE-bus commands: `INIT;*WAI;`
`CALC:MARK:FUNC:FPE 10;`
`CALC:MARK:FUNC:FPE:COUN?;`
`CALC:MARK:FUNC:FPE:Y?;`
`CALC:MARK:FUNC:FPE:X?`



The *SORT MODE FREQ/LEVEL* softkey defines the position of the peak values in the list:

FREQ sorting in ascending order of frequency values (time values if span = 0)
LEVEL sorting according to level

IEC/IEEE-bus command: `CALC:MARK:FUNC:FPE:SORT X;`

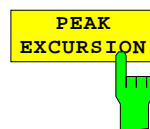

With level measurements, the *PEAK EXCURSION* softkey allows the minimum amount to be entered by which a signal must decrease or increase in order to be recognized as a maximum by the peak search function.

Values between 0 dB and 80 dB may be entered, the resolution being 0.1 dB

IEC/IEEE-bus command: `CALC:MARK:PEXC 6dB`

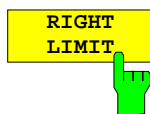
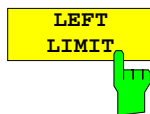

The *LEFT LIMIT* and *RIGHT LIMIT* softkeys define the vertical lines F1/F2 in the frequency domain (span > 0) and T1/T2 in the time domain (span = 0) between which the search is carried out. If only one line is active, the F1/T1 line is used as the lower limit; the upper limit is the stop frequency. If F2/T2 is also active, it defines the upper limit.

IEC/IEEE-bus commands: `CALC:MARK:X:SLIM:LEFT 1MHZ`
`CALC:MARK:X:SLIM:RIGH 10MHZ`
`CALC:MARK:X:SLIM ON`



The *THRESHOLD* softkey defines a horizontal threshold line which represents the lower limit of the peak search level range.

IEC/IEEE-bus command: `CALC:THR -20dBm`
`CALC:THR ON`



The *PEAK LIST OFF* softkey switches off the table with the search results.

IEC/IEEE-bus command: -

AF Demodulation

The R&S ESCI provides demodulators for AM and FM signals. With these demodulators, a displayed signal can be identified acoustically through the use of the internal loudspeaker or with headphones. The frequency at which the demodulation is enabled is coupled to the markers. The sweep stops at the frequency determined by the active marker for the selected time and the RF signal is demodulated. During a measurement in the time domain (span = 0 Hz) the demodulation is continuously on. The threshold line (*MKR->SEARCH LIMITS:THRESHOLD*) performs a squelch function in the demodulator. If the threshold is set, the R&S ESCI LF demodulation is switched on only when the signal to be demodulated exceeds the set threshold.

Menu *MKR FCTN*:

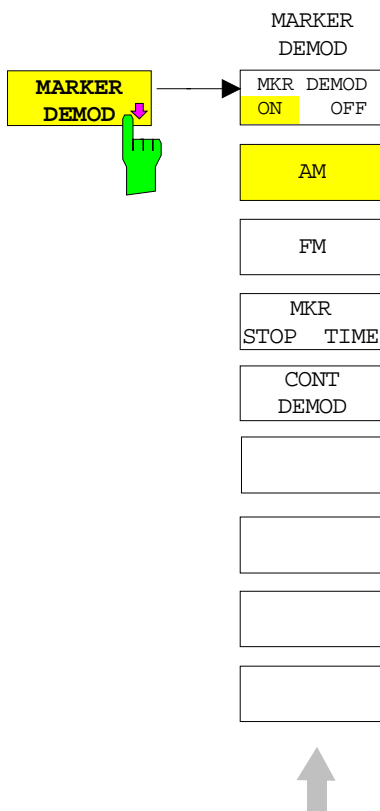

The *MARKER DEMOD* softkey switches on the audio demodulator and calls a submenu in which the demodulation mode and the duration of the demodulation can be selected.

IEC/IEEE-bus command: `CALC:MARK1:FUNC:DEM ON`

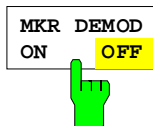

The *MKR DEMOD ON/OFF* softkey switches the demodulation on/off.

In the frequency range (span >0), the frequency scan is stopped at the frequency of the active marker with demodulation switched on – provided that the level is above the threshold line - and the signal is demodulated during the given stop time.

In the time domain (span = 0) demodulation is continuous, i.e. not only active at the marker position.

IEC/IEEE-bus command: `CALC:MARK1:FUNC:DEM ON`

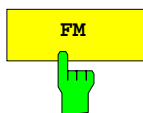
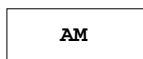

The softkeys *AM* and *FM* are selector switches one of which only may be active at a time. They set the desired demodulation mode FM or AM. Default setting is AM.

IEC/IEEE-bus command: `CALC:MARK1:FUNC:DEM:SEL AM`
`CALC:MARK1:FUNC:DEM:SEL FM`

The *MKR STOP TIME* softkey defines the stop time for demodulation at the marker(s).

The R&S ESCI interrupts the frequency sweep at the marker position and activates the demodulation for the duration of the stop time (see also *MKR DEMOD ON/OFF*).

In the time domain (span = 0) the demodulation is continuously active irrespective of the stop time set.

IEC/IEEE-bus command: `CALC:MARK1:FUNC:DEM:HOLD 3s`

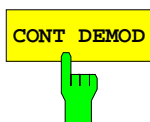

The *CONT DEMOD* softkey switches on the continuous demodulation in the frequency domain. If the sweep time is long enough, the set frequency range can be monitored acoustically.

IEC/IEEE-bus command: `CALC:MARK1:FUNC:DEM:CONT ON`

Selecting the Trace

Menu *MKR FCTN*:



The *MKR -> TRACE* softkey sets the active marker to different traces. Only those traces can be selected which are visible on the screen in the same window.

The function of the softkey is identical to that of the softkey with the same name in the *MKR->* menu.

Example:

Three traces are displayed on the screen. The marker is always on Trace 1 on switching on.

[*MKR ->TRACE*]

"1"<ENTER> The marker jumps to Trace 2, but remains at the previous frequency or time.

[*MKR ->TRACE*]

"3"<ENTER> The marker jumps to Trace 3.

IEC/IEEE-bus command: `CALC:MARK:TRAC 2`

Change of Settings via Markers – MKR ⇒ Key

The *MKR* → menu offers functions through which instrument parameters can be changed with the aid of the currently active marker. The functions can be used on markers and delta markers.

On opening the menu, the entry for the last active marker is activated; if no marker was enabled, *MARKER 1* is activated and a peak search is performed.

MKR → menu

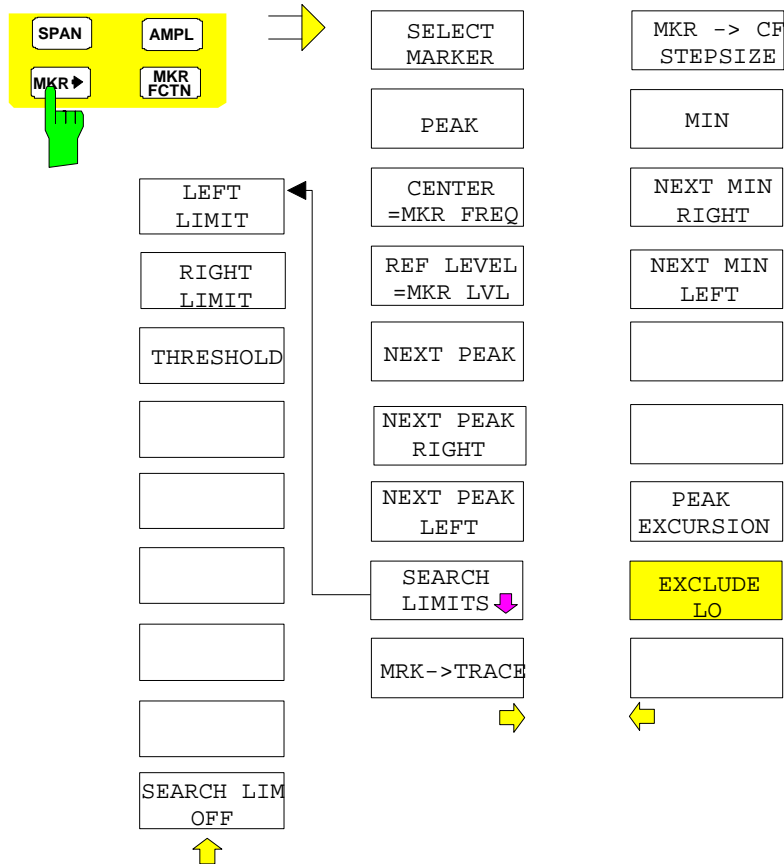

The *SELECT MARKER* softkey activates the numerical selection of the marker in the data entry field. Delta marker 1 is selected by input of '0'.

IEC/IEEE-bus commands: `CALC:MARK1 ON;`
`CALC:MARK1:X <value>;`
`CALC:MARK1:Y?`

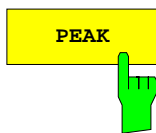

The *PEAK* softkey sets the active marker/delta marker to the peak of the trace.

If no marker is active when **MKR->** menu is called, *MARKER 1* is automatically switched on and the peak search is performed.

IEC/IEEE-bus commands: `CALC:MARK:MAX`
`CALC:DELT:MAX`



The *CENTER = MKR_FREQ* softkey sets the center frequency to the current marker or delta marker frequency.

A signal can thus be set to the center of the frequency display range, for example, so that it can then be examined in detail with a smaller span.

The softkey is not available in the time domain (zero span).

IEC/IEEE-bus command: `CALC:MARK:FUNC:CENT`

Example:

A spectrum is displayed with a large span after PRESET. A signal off the center is to be examined in detail:

[PRESET] R&S ESCI is set to the default setting.

[MKR->] *MARKER 1* is switched on and automatically jumps to the largest signal of the trace.

[*CENTER =MKR_FREQ*] The center frequency is set to the marker frequency. The span is adapted in such a way that the minimum frequency (= 0 Hz) or the maximum frequency is not exceeded.

[SPAN] The span can, for example, be reduced using the rollkey.



The *REF LEVEL = MKR_LVL* softkey sets the reference level to the current marker level.

IEC/IEEE-bus command: `CALC:MARK:FUNC:REF`

Example:

A spectrum is displayed with a large span after PRESET. A signal off the center is to be examined in detail:

[PRESET] R&S ESCI is set to the default setting.

[MKR->] *MARKER 1* is switched on and automatically jumps to the largest signal of the trace.

[*CENTER =MKR_FREQ*] The center frequency is set to the marker frequency. The span is adapted in such a way that the minimum frequency (= 0 Hz) or the maximum frequency is not exceeded.

[*REF LEVEL = MKR_LVL*] The reference level is set to the measured marker level.

[SPAN] The span can, for example, be reduced using the rollkey.

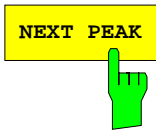

The *NEXT PEAK* softkey sets the active marker/delta marker to the next lower maximum of the selected trace.

IEC/IEEE-bus commands: `CALC:MARK:MAX:NEXT`
`CALC:DELT:MAX:NEXT`

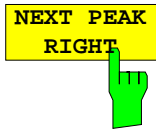

The *NEXT PEAK RIGHT* softkey sets the active marker/delta marker to the next lower maximum right of the current marker position on the selected trace.

IEC/IEEE-bus commands: `CALC:MARK:MAX:RIGH`
`CALC:DELT:MAX:RIGH`



The *NEXT PEAK LEFT* softkey sets the active marker/delta marker to the next lower maximum left of the current marker position the selected trace.

IEC/IEEE-bus commands: `CALC:MARK:MAX:LEFT`
`CALC:DELT:MAX:LEFT`



LEFT
LIMIT

RIGHT
LIMIT

THRESHOLD

SEARCH LIM
OFF



The *SEARCH LIMITS* softkey limits the search range for maximum or minimum search. The softkey switches to a submenu in which the search range limits can be set in the x and y direction.

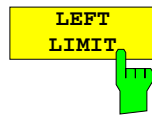

The *LEFT LIMIT* und *RIGHT LIMIT* softkeys define the two vertical lines F1 and F2 in the frequency domain (span > 0) and T1 / T2 in the time domain (span = 0). The search is performed between these lines in the frequency and time domain

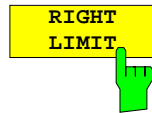

If only *LEFT LIMIT* is enabled, line F1/T1 is the lower limit and the upper limit corresponds to the stop frequency. If *RIGHT LIMIT* is also enabled, it determines the upper limit.

IEC/IEEE-bus commands: `CALC:MARK:X:SLIM:LEFT 1MHZ`
`CALC:MARK:X:SLIM:RIGH 10MHZ`
`CALC:MARK:X:SLIM ON`



The *THRESHOLD* softkey defines the threshold line. The threshold line represents a limit for the level range of the max. search at the lower end and that of the min. search at the upper end.

IEC/IEEE-bus commands: `CALC:THR -20dBm`
`CALC:THR ON`

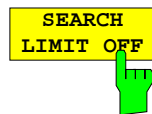

The *SEARCH LIMIT OFF* softkey disables all limits of the search range.

IEC/IEEE-bus commands: `CALC:MARK:X:SLIM OFF`
`CALC:THR OFF`

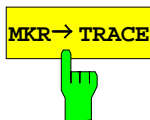

The *MKR->TRACE* softkey sets the active marker to a new trace. If only one trace is available on the screen, the softkey does not appear. If several traces are available on the screen, only these are offered.

IEC/IEEE-bus command: `CALC:MARK:TRAC 2`

Example:

Three traces are displayed on the screen. The marker is always on Trace 1 after switching on.

`[MKR ->TRACE] "2" <ENTER>` The marker jumps to Trace 2 but remains at the previous frequency or time.

`[MKR ->TRACE] "3" <ENTER>` The marker jumps to Trace 3.



The *MKR→CF STEPSIZE* softkey sets the step size for the center frequency variation to the current marker frequency, and also sets step size adaptation to *MANUAL*. *CF STEPSIZE* remains at this value until the center frequency entry mode in the STEP menu is switched from *MANUAL* to *AUTO* again.

The *MKR→CF STEPSIZE* function is, above all, useful in the measurement of harmonics with large dynamic range (narrow bandwidth and narrow span).

The softkey is not available in the time domain (span = 0 Hz).

IEC/IEEE-bus command: `CALC:MARK:FUNC:CST`

Example:

The harmonics levels of a CW carrier are to be measured at 100 MHz.

[PRESET] R&S ESCI is set to the default setting.

[CENTER: 100 MHz] R&S ESCI sets the center frequency to 100 MHz. The span is set to 200 MHz.

[SPAN: 1 MHz] The span is set to 100 MHz.

[MKR->] *MARKER 1* is switched on and set to the maximum value of the signal.

[NEXT] R&S ESCI switches to the submenu.

[*MKR->CF STEPSIZE*] The step size of the center frequency setting equals the marker frequency (100 MHz).

[CENTER] The center frequency entry mode is activated.

[Right key] The center frequency is set to 200 MHz. The first harmonic of the test signal is displayed.

[MKR->: PEAK] The marker is set to the harmonic and the level of the latter is output in the marker info field.

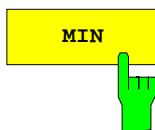

The *MIN* softkey sets the active marker/delta marker to the minimum of the selected trace.

IEC/IEEE-bus commands: `CALC:MARK:MIN`
`CALC:DELT:MIN`

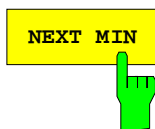

The *NEXT MIN* softkey sets the active marker/delta marker to the next higher minimum of the selected trace. The search direction is defined in the *NEXT MODE* submenu (see above).

IEC/IEEE-bus commands: `CALC:MARK:MIN:NEXT`
`CALC:DELT:MIN:NEXT`

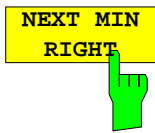

The *NEXT MIN RIGHT* softkey sets the active marker/delta marker to the next higher minimum right of the current marker position on the selected trace.

IEC/IEEE-bus commands: `CALC:MARK:MIN:RIGH`
 `CALC:DELT:MIN:RIGH`

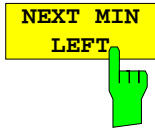

The *NEXT MIN LEFT* softkey sets the active marker/delta marker to the next higher minimum left of the current marker position on the selected trace.

IEC/IEEE-bus commands: `CALC:MARK:MIN:LEFT`
 `CALC:DELT:MIN:LEFT`

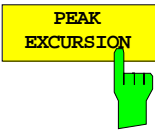

The *PEAK EXCURSION* softkey enables – for level measurements – the entry of a minimum level value by which a signal must rise or fall so that it will be identified as a maximum or a minimum by the *NEXT PEAK* and *NEXT MIN* search functions.

Valid entries are from 0 dB to 80 dB; the resolution is 0.1 dB.

IEC/IEEE-bus command: `CALC:MARK:PEXC 10dB`

The default setting for the peak excursion is 6 dB. This value is sufficient for the *NEXT PEAK* and *NEXT MIN* functions if *NEXT MODE ABS* is selected since, in this mode, the next lower maximum or next higher minimum will always be detected.

If *SEARCH NEXT LEFT* or *SEARCH NEXT RIGHT* is selected, the *NEXT PEAK* and *NEXT MIN* functions search for the next relative maximum or minimum right or left of the current marker position irrespective of the current signal amplitude. *Relative maximum* is understood to mean a decrease of the signal amplitude by a defined value – i.e. the peak excursion – right and left of the amplitude peak.

The 6 dB level change set as a default value may be attained already by the inherent noise of the instrument. In such a case, the R&S ESCI would identify noise peaks as maxima or minima. The value entered for the *PEAK EXCURSION* should therefore be higher than the difference between the highest and the lowest value measured for the displayed inherent noise.

The following example illustrates the effect of different settings of the *PEAK EXCURSION*.

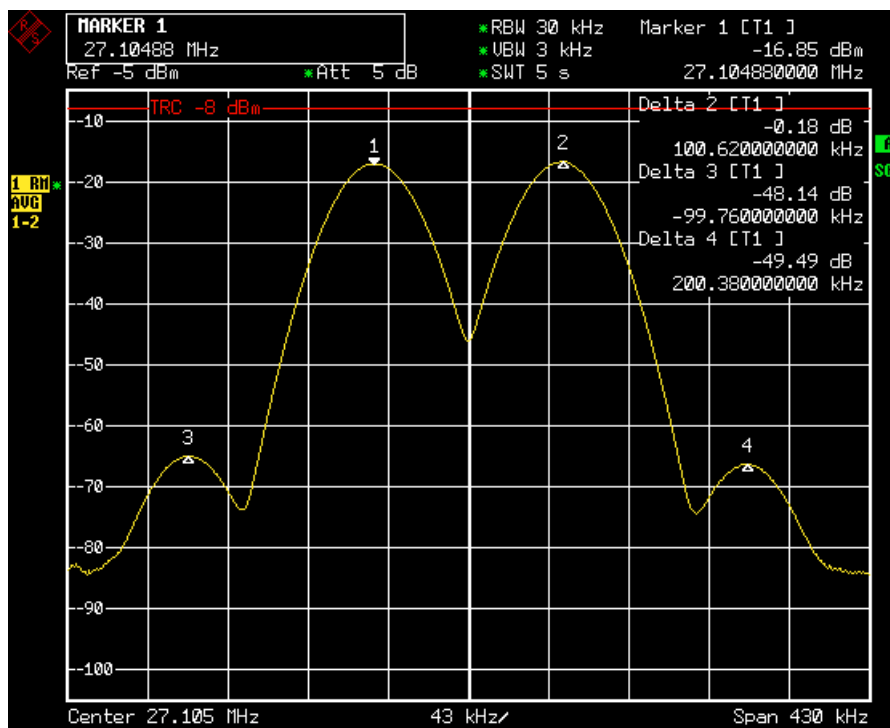

Fig. 4-13 Examples of level measurement with different settings of *PEAK EXCURSION*

Maximum relative level change between the measured signals:

Signal 1 to signal 2:	30 dB
Signal 1 to signal 3:	55 dB
Signal 1 to signal 4:	56 dB

With **40 dB peak excursion**, signal 3 will be detected by NEXT PEAK and signal 4 by NEXT PEAK RIGHT. Signal 2, by contrast, will not be detected because the signal level decreases by only 30 dB between signal 1 and signal 2. Signal 4 will not be detected with NEXT PEAK, as the signal level decreases by less than 40 dB between signal 3 and 4.

Order of signals detected:

PEAK:	signal 1
NEXT PEAK:	signal 3
NEXT PEAK:	no further signal detected

or

PEAK:	signal 1
NEXT PEAK RIGHT:	signal 4
NEXT PEAK RIGHT:	no further signal detected

With **20 dB peak excursion**, signal 2 will also be detected since the largest signal level change of 30 dB between signal 1 and 2 is now greater than the peak excursion.

Order of signals detected:

PEAK:	signal 1
NEXT PEAK:	signal 2
NEXT PEAK:	signal 3
NEXT PEAK:	no further signal detected

or

PEAK: signal 1
 NEXT PEAK RIGHT: signal 2
 NEXT PEAK RIGHT: signal 4
 NEXT PEAK RIGHT: no further signal detected

With 6 dB peak excursion, all signals will be detected with NEXT PEAK. With NEXT PEAK RIGHT, all signals to the right of signal 1 will be detected.
 Order of signals detected:

Order of signals detected:

PEAK: signal 1
 NEXT PEAK: signal 2
 NEXT PEAK: signal 3
 NEXT PEAK: signal 4

or

PEAK: signal 1
 NEXT PEAK RIGHT: signal 2
 NEXT PEAK RIGHT: signal 4
 NEXT PEAK RIGHT: no further signal detected

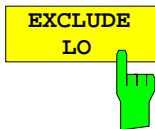

The *EXCLUDE LO* softkey limits the frequency range for the marker search functions or disables the limit.

- activated Because of the feedthrough of the first local oscillator to the first intermediate frequency at the input mixer, the LO is represented as a signal at 0 Hz. To avoid the marker jumping to the LO at 0 Hz with the peak function when setting the display range, this frequency is excluded. The minimum frequency to which the marker jumps, is $\geq 6 \times$ resolution bandwidth (RBW).
- deactivated No restriction to the search range. The frequency 0 Hz is included in the marker search functions.

IEC/IEEE-bus command: `CALC:MARK:LOEX ON`

Power Measurements – Hardkey MEAS

With its power measurement functions the R&S ESCI is able to measure all the necessary parameters with high accuracy in a wide dynamic range.

A modulated carrier is almost always used (except e.g. SSB-AM) for high-frequency transmission of information. Due to the information modulated upon the carrier, the latter covers a spectrum which is defined by the modulation, the transmission data rate and the signal filtering. Within a transmission band each carrier is assigned a channel taking into account these parameters. In order to ensure error-free transmission, each transmitter must be conforming to the specified parameters. These include among others:

- the output power,
- the occupied bandwidth, i.e. the bandwidth which must contain a defined percentage of the power and
- the power dissipation allowed in the adjacent channels.

Additionally the menu contains functions to determine the modulation depth of AM modulated signals and to measure the 3rd order intercept point.

The measurements and the corresponding settings are selected in the *MEAS* menu.

MEAS menu:

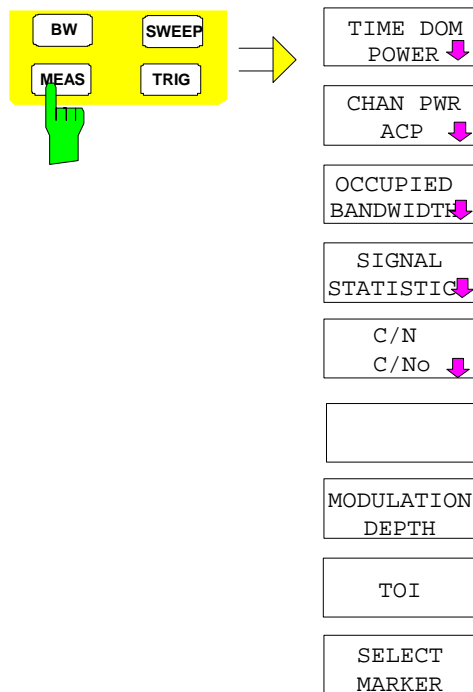

The *MEAS* key opens the menu to select and set the power measurement.

The following measurements can be selected:

- Power in the time domain (*TIME DOM POWER*)
- Channel power and adjacent-channel power in the frequency domain with a single carrier (*CHAN PWR ACP*)
- Channel power and adjacent-channel power in the frequency domain with several carriers (*MULT CARR ACP*)
- Occupied bandwidth (*OCCUPIED BANDWIDTH*)
- Carrier-to-noise ratio (*C/N, C/No*)
- Amplitude probability distribution (*SIGNAL STATISTICS*)
- Modulation depth (*MODULATION DEPTH*)
- 3rd order intercept (*TOI*)

The above measurements are carried out alternatively.

Power Measurement in Time Domain

With the aid of the power measurement function, the R&S ESCI determines the power of the signal in the time domain (SPAN = 0 Hz) by summing up the power at the individual pixels and dividing the result by the number of pixels. In this way it is possible to measure for example the power of TDMA signals during transmission or during the muting phase. Both the mean power and the rms power can be measured by means of the individual power values.

The result is displayed in the marker info field.

The measured values are updated after each sweep or averaged over a user-defined number of sweeps (AVERAGE ON/OFF and NUMBER OF SWEEPS) in order to determine e.g. the mean power over several bursts. For determination of the peak value (MAX HOLD ON) the maximum value from several sweeps is displayed.

Example:

Marker info field for: MEAN selected, AVERAGE ON and MAX HOLD ON:

```
MEAN HOLD      -2.33 dBm
MEAN AV        -2.39 dBm
```

If both the on and off phase of a burst signal are displayed, the measurement range can be limited to the transmission or to the muting phase with the aid of vertical lines. The ratio between signal and noise power of a TDMA signal for instance can be measured by using a measurement as a reference value and after that varying the measurement range.

Upon switching on power measurement the sample detector is activated (TRACE-DETECTOR-SAMPLE).

Submenu MEAS - TIME DOM POWER:

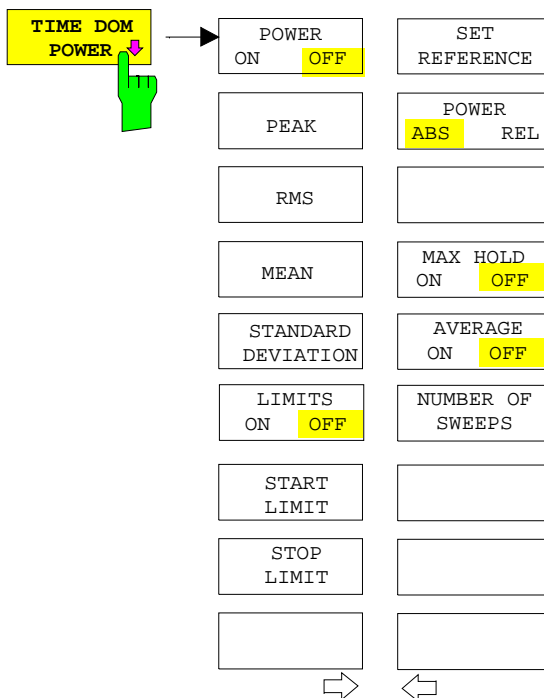

The *TIME DOM POWER* softkey activates the power measurement in the time domain and opens a submenu for configuration of the power measurement.

The submenu allows selection of the type of power measurement (rms or mean power), the settings for max hold and averaging as well as the definition of limits.

The power evaluation range can be limited by input of limit values.

Note: This softkey is only available in time domain (SPAN = 0).

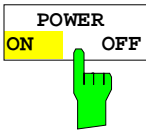

The *POWER ON/OFF* softkey switches the power measurement on and off. When entering the submenu it is *ON* since the power measurement is already switched on with the *TIME DOM POWER* softkey in the main menu.

Note: *The measurement is performed on the trace on which marker 1 is placed. To evaluate another trace, marker 1 should be set on another trace using the SELECT TRACE softkey in menu MKR.*

IEC/IEEE-bus command: `CALC:MARK:FUNC:SUMM:PPE ON`
 `CALC:MARK:FUNC:SUMM:PPE:RES?`
 `CALC:MARK:FUNC:SUMM:RMS ON`
 `CALC:MARK:FUNC:SUMM:RMS:RES?`
 `CALC:MARK:FUNC:SUMM:MEAN ON`
 `CALC:MARK:FUNC:SUMM:MEAN:RES?`
 `CALC:MARK:FUNC:SUMM:SDEV ON`
 `CALC:MARK:FUNC:SUMM:SDEV:RES?`

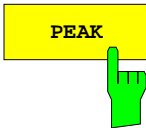

The *PEAK* softkey switches on the calculation of the peak value from the points of the displayed trace or a segment thereof.

For the maximum peak, the largest peak value obtained since the activation of *MAX HOLD ON* is displayed.

With *AVERAGE ON*, the peak values of a trace are averaged over several sweeps and displayed.

The number of sweeps over which the average or the maximum value is calculated is set with the *NUMBER OF SWEEPS* softkey.

IEC/IEEE-bus command: `CALC:MARK:FUNC:SUMM:PPE ON`
 `CALC:MARK:FUNC:SUMM:PPE:RES?`

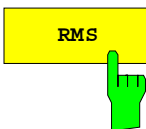

The *RMS* softkey switches on the calculation of the rms value from the points of the displayed trace or a segment of it.

For the maximum peak, the largest rms value obtained since the activation of *MAX HOLD ON* is displayed.

With *AVERAGE ON*, the rms values of a trace are averaged over several sweeps and displayed.

The number of sweeps over which the average or the maximum value is calculated is set with the *NUMBER OF SWEEPS* softkey.

IEC/IEEE-bus command: `CALC:MARK:FUNC:SUMM:RMS ON`
 `CALC:MARK:FUNC:SUMM:RMS:RES?`

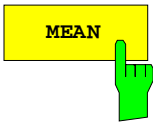

The *MEAN* softkey switches on the calculation of the mean value from the points of the displayed trace or a segment of it. The linear mean value of the equivalent voltages is calculated.

This can be used for instance to measure the mean power during a GSM burst.

For the maximum peak, the largest mean value obtained since the activation of *MAX HOLD ON* is displayed.

With *AVERAGE ON*, the mean values of a trace are averaged over several sweeps and displayed.

The number of sweeps over which the average or the maximum value is calculated is set with the *NUMBER OF SWEEPS* softkey.

IEC/IEEE-bus command: `CALC:MARK:FUNC:SUMM:MEAN ON`
 `CALC:MARK:FUNC:SUMM:MEAN:RES?`



The *STANDARD DEVIATION* softkey switches on the calculation of the standard deviation of trace points from the mean value and outputs them as measured value. The measurement of the mean power is automatically switched on at the same time.

For the maximum peak, the largest standard deviation obtained since the activation of *MAX HOLD ON* is displayed.

With *AVERAGE ON*, the standard deviations of a trace are averaged over several sweeps and displayed.

The number of sweeps over which the average or the maximum value is calculated is set with the *NUMBER OF SWEEPS* softkey.

IEC/IEEE-bus command: `CALC:MARK:FUNC:SUMM:SDEV ON`
 `CALC:MARK:FUNC:SUMM:SDEV:RES?`

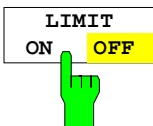

The *LIMIT ON/OFF* softkey selects the limited (*ON*) or non-limited (*OFF*) evaluation range.

The evaluation range is defined by the *START LIMIT* and *STOP LIMIT* softkeys. If *LIMIT = ON*, signals are only searched between the two lines.

If only one limit line is switched on, time line 1 is the lower limit and the upper limit corresponds to the stop frequency. If time line 2 is also switched on, it defines the upper limit.

If no limit line is switched on, the evaluation range is not limited.

The default setting is *LIMIT = OFF*.

IEC/IEEE-bus command: `CALC:MARK:X:SLIM OFF`

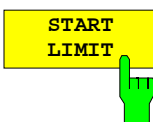

The *START LIMIT* softkey activates the entry of the lower limit of the evaluation range.

IEC/IEEE-bus command: `CALC:MARK:X:SLIM:LEFT <value>`

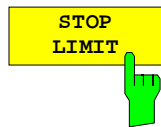

The *STOP LIMIT* softkey activates the entry of the upper limit of the evaluation range.

IEC/IEEE-bus command: `CALC:MARK:X:SLIM:RIGH <value>`

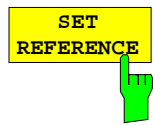

The *SET REFERENCE* softkey sets the power values currently measured as reference values for the calculation of the mean value (*MEAN*) and the rms value (*RMS*). The reference values are used to perform relative measurements.

If the calculation of the mean value (*MEAN*) and rms value (*RMS*) is not switched on, 0 dBm is used as a reference value.

If the average value (*AVERAGE*) or maximum value (*MAX HOLD*) is calculated over several sweeps, the current value is the measured value summed up at the actual time.

IEC/IEEE-bus command: `CALC:MARK:FUNC:SUMM:REF:AUTO ONCE`

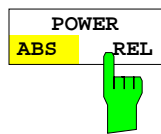

The *POWER ABS/REL* softkey selects the absolute power measurement (default setting) or relative power measurement. The reference value for the relative power is defined by *SET REFERENCE*.

The value 0 dBm is used if the reference value is not defined.

IEC/IEEE-bus command: `CALC:MARK:FUNC:SUMM:MODE ABS`

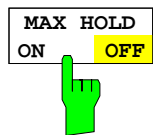

The *MAX HOLD ON/OFF* softkey switches the display of the maximum peak obtained from measurements at successive sweeps on and off.

The displayed maximum peak is only updated at the end of a sweep if a higher value has occurred.

The maximum value can be reset by switching the *MAX HOLD ON / OFF* softkey off and on again.

IEC/IEEE-bus command: `CALC:MARK:FUNC:SUMM:PHOL ON`
`CALC:MARK:FUNC:SUMM:PPE:PHOL:RES?`
`CALC:MARK:FUNC:SUMM:RMS:PHOL:RES?`
`CALC:MARK:FUNC:SUMM:MEAN:PHOL:RES?`
`CALC:MARK:FUNC:SUMM:SDEV:PHOL:RES?`

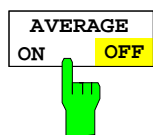

The *AVERAGE ON/OFF* softkey switches averaging over successive sweep measurements on and off.

The measured values can be reset by switching the *AVERAGE ON / OFF* softkey off and on again.

IEC/IEEE-bus command: `CALC:MARK:FUNC:SUMM:AVER ON`
`CALC:MARK:FUNC:SUMM:PPE:AVER:RES?`
`CALC:MARK:FUNC:SUMM:RMS:AVER:RES?`
`CALC:MARK:FUNC:SUMM:MEAN:AVER:RES?`
`CALC:MARK:FUNC:SUMM:SDEV:AVER:RES?`

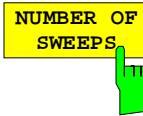

The *NUMBER OF SWEEPS* softkey activates the entry of the number of sweeps for maximum or average value calculation.

SINGLE SWEEP mode The R&S ESCI performs sweeps until the selected number of sweeps is reached and stops then.

CONTINUOUS SWEEP mode Averaging is carried out until the selected number of sweeps is reached. After that, averaging is performed in continuous mode, and is then continued as running averaging. Calculation of the maximum peak (*MAX HOLD*) is performed continuously irrespective of the selected number of sweeps.

The valid range values is 0 to 32767.

Depending on the specified number of sweeps, averaging is carried out according to the following rules:

NUMBER OF SWEEPS = 0 Continuous averaging is carried out over 10 measured values.

NUMBER OF SWEEPS = 1 No averaging is carried out.

NUMBER OF SWEEPS > 1 Averaging is carried out over the set number of measured values.

Note: *This setting is equivalent to the setting of the sweep count in the TRACE menu.*

IEC/IEEE-bus command: `SWE:COUN <value>`

Example:

The mean power of a GSM burst with 0 dBm nominal power at 800 MHz is to be measured.

[PRESET]	Set the R&S ESCI to the default setting.
[FREQ: CENTER: 800 MHz]	Set the center frequency to 800 MHz.
[SPAN: ZERO SPAN]	Select time domain display (span = 0 Hz).
[AMPT: 0 dBm]	Set the reference level to 0 dBm.
[BW: RES BW MANUAL: 30 kHz]	Set the resolution bandwidth to 30 kHz in line with the requirements of the GSM standard.
[SWEEP: SWEEPTIME MANUAL 600 µs]	Set the sweep time to 600 µs.
[TRIG: VIDEO: 50 %]	Use the video signal as trigger source.
[MEAS]	Call the menu for the measurement functions.
[TIME DOM POWER]	Select power measurement in the time domain. The R&S ESCI calculates the mean power from the points of the whole trace. The submenu for configuration of the power measurement is opened. <i>MEAN</i> is already switched on.
[LIMITS ON]	Activate the limitation of the time domain of the power measurement .
[START LIMIT: 250 µs]	Set the start of the power measurement at 250 µs.
[STOP LIMIT: 500 µs]	Set the end of the power measurement at 500 µs.

Note: *The GSM specifications require the power to be measured between 50% and 90% of the TDMA burst. The time limits set above approximately correspond to the required time domain.*

Channel and Adjacent-Channel Power Measurements

For all channel and adjacent-channel power measurements a specified channel configuration is assumed which is for instance based on a specific radiocommunication system.

This configuration is defined by the nominal channel frequency (= center frequency of the R&S ESCI if only one carrier is active), the channel bandwidth, the channel spacing, the adjacent-channel bandwidth and the adjacent-channel spacing. The R&S ESCI is able to simultaneously measure the power in up to four transmission channels and up to three adjacent channels (18 channels: 12 transmission channels, 3 lower and 3 upper adjacent channels).

It offers two methods for channel and adjacent-channel power measurement:

- The integrated bandwidth method (IBW method), i.e. the integration of trace pixels within the bandwidth of the channel to be measured to the total power of the channel,
- The measurement in time domain (Fast ACP) by means of steep resolution filters simulating the channel.

The two measurements yield the same results. The measurement in time domain can be performed much faster since the complete signal is measured within a channel at the same time. With the IBW method, the channel is divided into subspectra. This is done by means of a bandwidth which is small compared to the channel bandwidth. These subspectra are then combined by integration of the trace pixels.

With the IBW method, the transmission channels or adjacent channels are marked by vertical lines at a distance of half the channel bandwidth to the left and to the right of the corresponding channel center frequency(see Fig. 4-14).

With the time-domain method, the power versus time is shown for each channel. The boundaries of the channels are marked by vertical lines (see Fig. 4-15).

For both methods, the results are listed in tables in the lower half of the screen.

The R&S ESCI offers predefined standard settings which can be selected from a table for the common mobile radio standards. Thus, channel configuration is performed automatically without the need to enter the corresponding parameters manually.

For some standards, the channel power and the adjacent-channel power are to be weighted by means of a root-raised cosine filter corresponding to a receive filter. This type of filtering is switched on automatically for both methods on selecting the standard (e.g. NADC, TETRA or 3GPP W-CDMA).

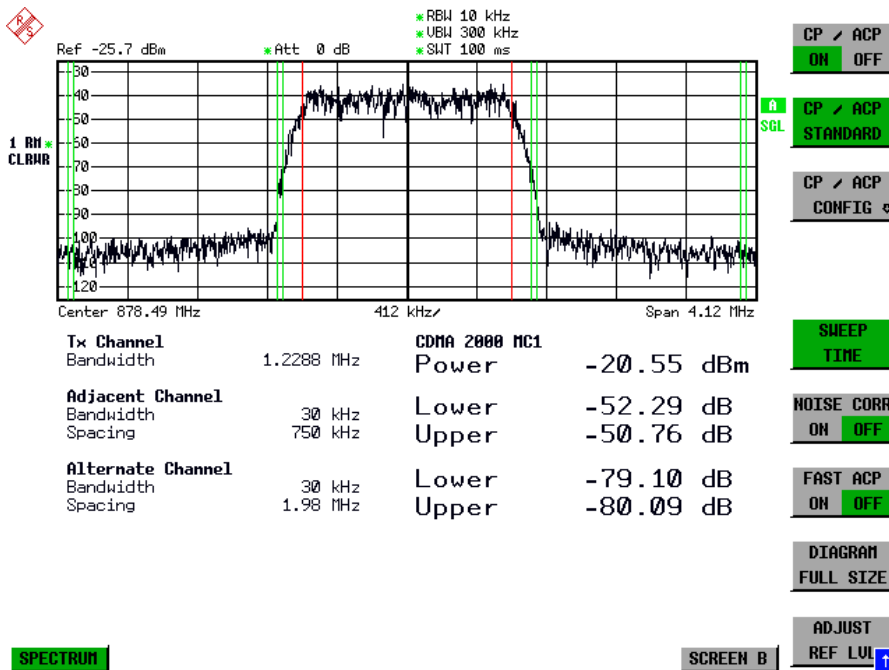

Fig. 4-14 Screen display of adjacent-channel power measurement using the IBW method

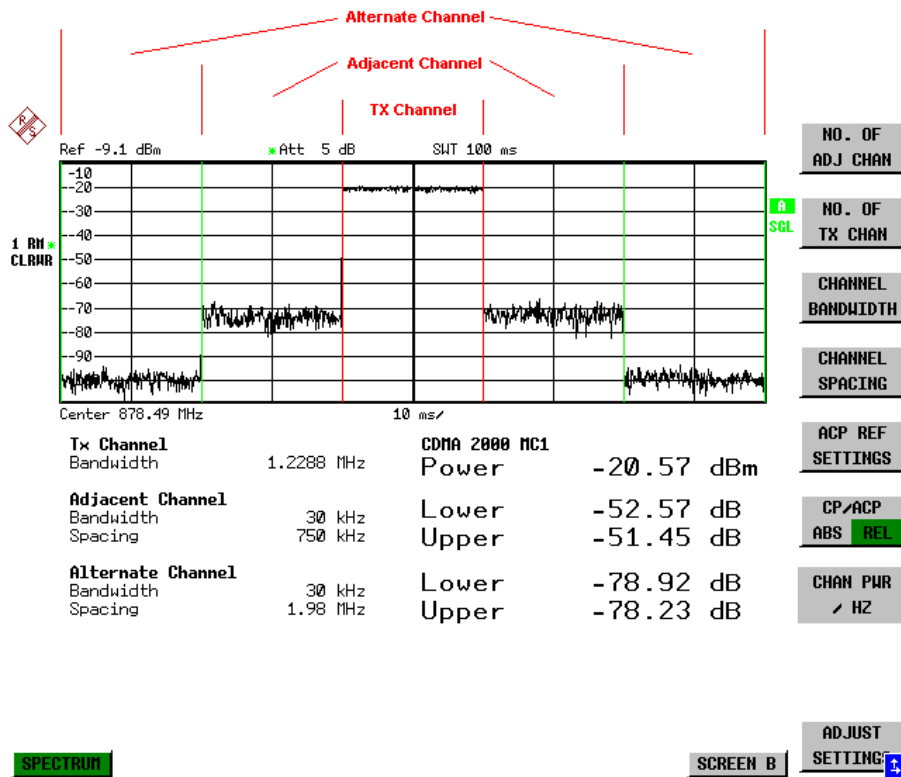
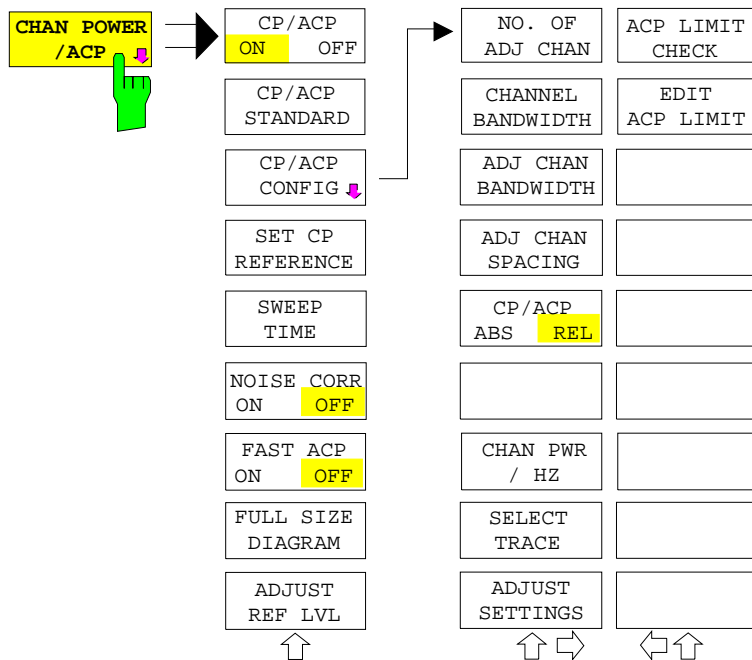

Fig. 4-15 Screen display of adjacent-channel power measurement using the time-domain method

Limit values for the adjacent-channel power can be defined for the measurement. If limit checking is switched on, a pass/fail information indicating that the power has been exceeded is displayed during the measurement in the table in the lower half of the screen.

Note: With the CP/ACP measurement switched on the functions SPLIT SCREEN and FULL SCREEN are inhibited.

The channel configuration is defined in the *MEAS - CHAN PWR ACP* or the *MEAS - MULT CARR ACP* menu.



The *CHAN PWR ACP* and *MULT CARR ACP* softkeys activate channel or adjacent-channel power measurement either for a single carrier signal (*CHAN PWR ACP*) or for several carrier signals (*MULT CARR ACP*), depending on the current measurement configuration. In addition, they open a submenu for defining the parameters for channel power measurement. The softkey selected is shown in colour to indicate that a channel or adjacent-channel power measurement is active.

Note: The softkeys are available only for measurements in the frequency domain (span > 0).

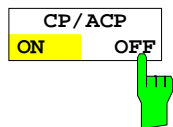

The *CP/ACP ON/OFF* softkey switches calculation of the channel power or adjacent-channel power on and off.

With default settings the measurement is performed by integrating the powers at the display points within the specified channels (IBW method).

The powers of the adjacent channels are measured either as absolute values or as relative values referenced to the power of a transmission channel. The default setting is relative-value measurement (see *CP/ACP ABS/REL* softkey).

When multicarrier ACP measurement is activated, the number of test points is increased to ensure that adjacent-channel powers are measured with adequate accuracy.

IEC/IEEE-bus commands: `CALC:MARK:FUNC:POW:SEL CPOW|ACP|MCAC`
`CALC:MARK:FUNC:POW:RES? CPOW|ACP|MCAC`
`CALC:MARK:FUNC:POW OFF`

CP/ACP
STANDARD



The *CP/ACP STANDARD* softkey opens a table for the selection of the settings according to predefined standards. The test parameters for the channel and adjacent-channel measurements are set according to the mobile radio standard.

ACP STANDARD
✓NONE
NADC IS136
TETRA
PDC
PHS
CDPD
CDMA IS95A FWD
CDMA IS95A REV
CDMA IS95C Class 0 FWD
CDMA IS95C Class 0 REV
CDMA J-STD008 FWD
CDMA J-STD008 REV
CDMA IS95C Class 1 FWD
CDMA IS95C Class 1 REV
W-CDMA 4.096 FWD
W-CDMA 4.096 REV
W-CDMA 3GPP FWD
W-CDMA 3GPP REV
CDMA 2000 DS
CDMA 2000 MC1
CDMA 2000 MC3
TD-SCDMA

The standards available are listed in the table on the left.

Note: For the R&S ESCI, the channel spacing is defined as the distance between the center frequency of the adjacent channel and the center frequency of the transmission channel. The definition of the adjacent-channel spacing in standards IS95 B and C, IS97 B and C and IS98 B and C is different. These standards define the adjacent-channel spacing from the center of the transmission channel to the closest border of the adjacent channel. This definition is also used for the R&S ESCI when the following standard settings are selected:

- CDMA IS95 Class 0 FWD
- CDMA IS95 Class 0 REV
- CDMA IS95 Class 1 FWD
- CDMA IS95 Class 1 REV

The selection of the standard influences the following parameters:

- channel spacing and adjacent-channel spacing
- channel bandwidth, adjacent-channel bandwidth, and type of filtering
- resolution bandwidth
- video bandwidth
- detector
- # of adjacent channels

Trace mathematics and trace averaging are switched off.

The reference level is not influenced by the selection of a standard. To achieve an optimum dynamic range, the reference level has to be set in a way that places the signal maximum close to the reference level without forcing an overload message.

The default setting is *CP/ACP STANDARD NONE*.

IEC/IEEE-bus command: `CALC:MARK:FUNC:POW:PRES <standard>`

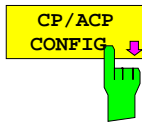

See following section "Setting the Channel Configuration"

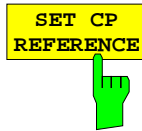

With channel power measurement activated, the *SET CP REFERENCE* softkey defines the currently measured channel power as the reference value. The reference value is displayed in the *CH PWR REF* field; the default value is 0 dBm.

In adjacent-channel power measurement with one or several carrier signals, the power is always referenced to a transmission channel, i.e. no value is displayed for *CH PWR REF*.

IEC/IEEE-bus command: `POW:ACH:REF:AUTO ONCE`



The *SWEEP TIME* softkey activates the entry of the sweep time. With the RMS detector, a longer sweep time increases the stability of the measurement results.

The function of the softkey is identical to the softkey *SWEEP TIME MANUAL* in the menu *BW*.

IEC/IEEE-bus command: `SWE:TIM <value>`

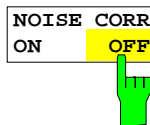

If the *NOISE CORR ON/OFF* softkey is activated, the results will be corrected by the instrument's inherent noise, which increases the dynamic range.

When the function is switched on, a reference measurement of the instrument's inherent noise is carried out. The noise power measured is then subtracted from the power in the channel that is being examined.

The inherent noise of the instrument depends on the selected center frequency, resolution bandwidth and level setting. Therefore, the correction function is disabled whenever one of these parameters is changed. A disable message is displayed on the screen.

To enable the correction function in conjunction with the changed setting, press the softkey once more. A new reference measurement is carried out.

IEC/IEEE-bus command: `SENS:POW:NCOR ON`

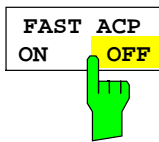

The *FAST ACP* softkey switches between the IBW method (*FAST ACP OFF*) and the time domain method (*FAST ACP ON*).

With *FAST ACP ON* the power measurement is performed in the different channels in the time domain. The R&S ESCI sets the center frequency consecutively to the different channel center frequencies and measures the power with the selected measurement time (= sweep time/number of channels). The RBW filters suitable for the selected standard and frequency offset are automatically used (e.g. root raised cos with IS 136). The list of available channel filters is included in section "Setting of Bandwidths and Sweep Time – *BW key*".

The RMS detector is used for obtaining correct power measurement results. Therefore this requires no software correction factors.

Measured values are output as a list. The powers of the transmission channels are output in dBm, the powers of the adjacent channels in dBm (*CP/ACP ABS*) or dB (*CP/ACP REL*).

The sweep time is selected depending on the desired reproducibility of results. Reproducibility increases with sweep time since power measurement is then performed over a longer time period.

As a general approach, it can be assumed that approx. 500 non-correlated measured values are required for a reproducibility of 0.5 dB (99% of the measurements are within 0.5 dB of the true measured value). This holds true for white noise. The measured values are considered as non-correlated when their time interval corresponds to the reciprocal of the measured bandwidth.

With IS 136 the measurement bandwidth is approx. 25 kHz, i.e. measured values at an interval of 40 μ s are considered as noncorrelated. A measurement time of 20 ms is thus required per channel for 1000 measured values. This is the default sweep time which the R&S ESCI sets in coupled mode. Approx. 5000 measured values are required for a reproducibility of 0.1 dB (99%), i.e. the measurement time is to be increased to 200 ms.

IEC/IEEE-bus command `SENS:POW:HSP ON`

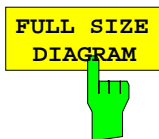

The *FULL SIZE DIAGRAM* softkey switches the diagram to full screen size.

IEC/IEEE-bus command: `DISP:WIND1:SIZE LARG|SMAL`

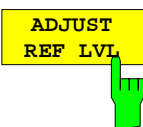

The *ADJUST REF LVL* softkey adjusts the reference level of the R&S ESCI to the measured channel power. This ensures that the settings of the RF attenuation and the reference level are optimally adjusted to the signal level without overloading the R&S ESCI or limiting the dynamic range by a too small S/N ratio.

Since the measurement bandwidth for channel power measurements is significantly lower than the signal bandwidth, the signal path may be overloaded although the trace is still significantly below the reference level.

IEC/IEEE-bus command: `SENS:POW:ACH:PRES:RLEV`

For manual setting of the test parameters different from the settings made with *ADJUST SETTINGS* the following should be observed:

Frequency span	<p>The frequency span must at least cover the channels to be measured plus a measurement margin of 10%. For channel power measurement, the span is 1.1 x channel bandwidth. Note: <i>If the frequency span is large in comparison with the channel bandwidth (or the adjacent-channel bandwidths) being examined, only a few points on the trace are available per channel. This reduces the accuracy of the waveform calculation for the channel filter used, which has a negative effect on the measurement accuracy.</i> <i>We therefore strongly recommend that the formulas mentioned be taken into consideration when selecting the frequency span.</i></p>
Resolution bandwidth (RBW)	<p>To ensure both an acceptable measurement speed and the required selection (to suppress spectral components outside the channel to be measured, especially of the adjacent channels), the resolution bandwidth must not be selected too small or too large. As a general approach, the resolution bandwidth is to be set to values between 1% and 4% of the channel bandwidth. A larger resolution bandwidth can be selected if the spectrum within the channel to be measured and around it has a flat characteristic. In the standard setting, e.g. for standard IS95A REV at an adjacent channel bandwidth of 30 kHz, a resolution bandwidth of 30 kHz is used. This yields correct results since the spectrum in the neighbourhood of the adjacent channels normally has a constant level. For standard NADC/IS136 this is not possible for example, since the spectrum of the transmit signal penetrates into the adjacent channels and a too large resolution bandwidth causes a too low selection of the channel filter. The adjacent-channel power would thus be measured too high. With the exception of the IS95 CDMA standards, the <i>ADJUST SETTINGS</i> softkey sets the resolution bandwidth (RBW) as a function of the channel bandwidth: $RBW \leq 1/40$ of channel bandwidth. The maximum possible resolution bandwidth (with respect to the requirement $RBW \leq 1/40$) resulting from the available RBW steps (1, 3) is selected.</p>
Video bandwidth (VBW)	<p>For a correct power measurement, the video signal must not be limited in bandwidth. A restricted bandwidth of the logarithmic video signal would cause signal averaging and thus result in a too low indication of the power (-2.51 dB at very low video bandwidths). The video bandwidth should therefore be selected at least three times the resolution bandwidth. The <i>ADJUST SETTINGS</i> softkey sets the video bandwidth (VBW) as a function of the channel bandwidth as follows: $VBW \geq 3 \times RBW$. The smallest possible VBW with regard to the available step size will be selected.</p>
Detector	<p>The <i>ADJUST SETTINGS</i> softkey selects the RMS detector. The RMS detector is selected since it correctly indicates the power irrespective of the characteristics of the signal to be measured. In principle, the sample detector would be possible as well. Due to the limited number of trace pixels used to calculate the power in the channel, the sample detector would yield less stable results. Averaging, which is often performed to stabilize the measurement results, leads to a too low level indication and should therefore be avoided. The reduction in the displayed power depends on the number of averages and the signal characteristics in the channel to be measured.</p>

Setting the Channel Configuration

MEAS - CP/ACP CONFIG submenu:

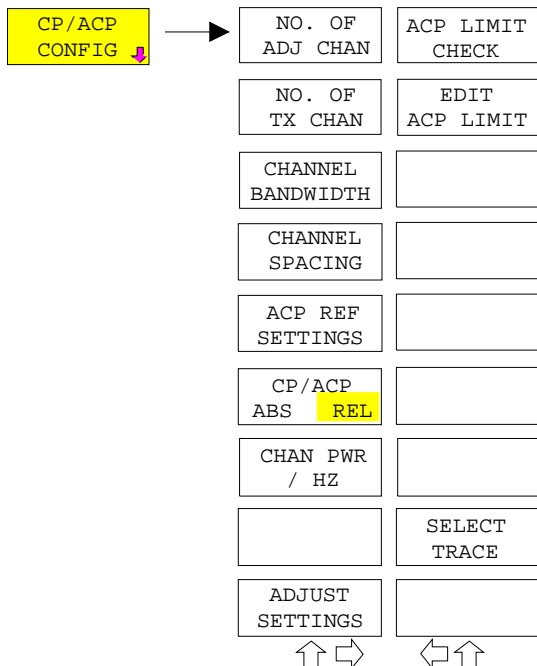

The *CP/ACP CONFIG* softkey opens a submenu for configuration of the channel power and adjacent channel power measurement independently of the offered standards.

The channel configuration includes the number of channels to be measured, the channel bandwidths (*CHANNEL BANDWIDTH*), and the channel spacings (*CHANNEL SPACING*).

Limit values can additionally be specified for the adjacent-channel power (*ACP LIMIT CHECK* and *EDIT ACP LIMITS*) which are checked for compliance during the measurement.



The *NO. OF ADJ CHAN* softkey activates the entry of the number $\pm n$ of adjacent channels to be considered in the adjacent-channel power measurement. Numbers from 0 to 3 can be entered.

The following measurements are performed depending on the number of the channels.

- 0 Only the channel powers are measured.
- 1 The channel powers and the power of the upper and lower adjacent channel are measured.
- 2 The channel powers, the power of the upper and lower adjacent channel and of the next higher and lower channel (alternate channel 1) are measured.
- 3 The channel power, the power of the upper and lower adjacent channel, the power of the next higher and lower channel (alternate channel 1) and of the next but one higher and lower adjacent channel (alternate channel 2) are measured.

IEC/IEEE-bus command: POW:ACH:ACP 1



The *NO. OF TX CHAN* softkey enables the entry of the number of carrier signals to be considered in channel and adjacent-channel power measurements.

Numbers from 1 to 12 can be entered.

The softkey is available only for multicarrier ACP measurements.

IEC/IEEE-bus command: SENS:POW:ACH:TXCH:COUN 4

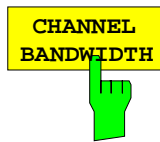

The *CHANNEL BANDWIDTH* softkey opens a table for defining the channel bandwidths for the transmission channels and the adjacent channels.

ACP CHANNEL BW	
CHAN	BANDWIDTH
ADJ	14 kHz
ALT1	14 kHz
ALT2	14 kHz

The transmission-channel bandwidth is normally defined by the transmission standard. The correct bandwidth is set automatically for the selected standard (see *CP/ACP STANDARD* softkey).

With the IBW method (*FAST ACP OFF*), the channel bandwidth limits are marked by two vertical lines right and left of the channel center frequency. It can in this way be visually checked whether the entire power of the signal under test is within the selected channel bandwidth.

Measurements in the time domain (*FAST ACP ON*) are performed in the zero span mode. The channel limits are indicated by vertical lines. For measurements requiring channel bandwidths deviating from those defined in the selected standard the IBW method is to be used.

Refer to section "Setting of Bandwidths and Sweep Time – *BW* key" for a list of available channel filters.

When measuring according to the IBW method (*FAST ACP OFF*) the bandwidths of the different adjacent channels are to be entered numerically. Since all adjacent channels often have the same bandwidth, the other channels Alt1 and Alt2 are set to the bandwidth of the adjacent channel on entering the adjacent-channel bandwidth (*ADJ*). Thus only one value needs to be entered in case of equal adjacent channel bandwidths. The same holds true for the *ALT2* channels (alternate channels 2) when the bandwidth of the *ALT1* channel (alternate channel 1) is entered.

Note: *The channel spacings can be set separately by overwriting the table from top to bottom.*

IEC/IEEE-bus command: `SENS:POW:ACH:BWID:CHAN 14kHz`
`SENS:POW:ACH:BWID:ACH 1kHz`
`SENS:POW:ACH:BWID:ALT1 14kHz`
`SENS:POW:ACH:BWID:ALT2 14kHz`



The *CHANNEL SPACING* softkey opens a table for defining the channel spacings.

ACP CHANNEL SPACING	
CHAN	SPACING
ADJ	20 kHz
ALT1	40 kHz
ALT2	60 kHz

Since all the adjacent channels often have the same distance to each other, the entry of the adjacent-channel spacing (ADJ) causes channel spacing ALT1 to be set to twice and channel spacing ALT2 to three times the adjacent-channel spacing. Thus only one value needs to be entered in case of equal channel spacing. The same holds true for the ALT2 channels when the bandwidth of the ALT1 channel is entered.

Note: *The channel spacings can be set separately by overwriting the table from top to bottom. The entry "TX" is only available for the multicarrier ACP measurement.*

IEC/IEEE-bus command: SENS:POW:ACH:SPAC:CHAN 20kHz
 SENS:POW:ACH:SPAC:ACH 20kHz
 SENS:POW:ACH:SPAC:ALT1 40kHz
 SENS:POW:ACH:SPAC:ALT2 60kHz

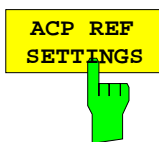

The *ACP REF SETTINGS* softkey opens a table for selecting the transmission channel to which the adjacent-channel relative power values should be referenced.

ACP REFERENCE CHANNEL	
<input checked="" type="checkbox"/>	TX CHANNEL 1
<input type="checkbox"/>	TX CHANNEL 2
<input type="checkbox"/>	TX CHANNEL 3
<input type="checkbox"/>	TX CHANNEL 4
<input type="checkbox"/>	MIN POWER TX CHANNEL
<input type="checkbox"/>	MAX POWER TX CHANNEL
<input type="checkbox"/>	LOWEST & HIGHEST CHANNEL

- TX CHANNEL 1 - 4 Selection of one of channels 1 to 4.
- MIN POWER TX CHANNEL The transmission channel with the lowest power is used as a reference channel.
- MAX POWER TX CHANNEL The transmission channel with the highest power is used as a reference channel.
- LOWEST & HIGHEST CHANNEL The outer lefthand transmission channel is the reference channel for the lower adjacent channels, the outer righthand transmission channel that for the upper adjacent channels.

Note:

The softkey is only available for the multicarrier ACP measurement.

IEC/IEEE-bus command:

```
SENS:POW:ACH:REF:TXCH:MAN 1
SENS:POW:ACH:REF:TXCH:AUTO MIN
```

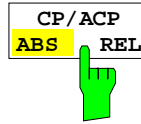

The *CP/ACP ABS/REL* softkey (channel power absolute/relative) switches between absolute and relative power measurement in the channel.

CP/ACP ABS The absolute power in the transmission channel and in the adjacent channels is displayed in the unit of the Y axis, e.g. in dBm, dBμV.

CP/ACP REL For adjacent-channel power measurements (*NO. OF ADJ CHAN > 0*), the level of the adjacent channels is displayed relative to the level of the transmission channel in dBc.

For channel power measurements (*NO. OF ADJ CHAN = 0*) with a single carrier, the power of the transmission channel is displayed relative to the power of a reference channel defined by *SET CP REFERENCE*. This means:

1. Declare the power of the currently measured channel as the reference value, using the *SET CP REFERENCE* softkey.
2. Select the channel of interest by varying the channel frequency (R&S ESCI center frequency).

With linear scaling of the Y axis, the power of the new channel relative to the reference channel (CP/CP_{ref}) is displayed. With dB scaling, the logarithmic ratio $10\lg(CP/CP_{ref})$ is displayed.

The relative channel power measurement can thus also be used for universal adjacent-channel power measurements. Each channel can be measured individually.

IEC/IEEE-bus command: `SENS:POW:ACH:MODE ABS`

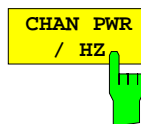

The *CHAN PWR / HZ* softkey toggles between the measurement of the total channel power and the measurement of the channel power referenced to a 1-Hz bandwidth.

The conversion factor is $10 \cdot \lg \frac{1}{\text{Channel} \cdot \text{Bandwidth}}$.

By means of this function it is possible e.g. to measure the signal/noise power density or use the additional functions *CP/ACP REL* and *SET CP REFERENCE* to obtain the signal to noise ratio.

IEC/IEEE-bus command:

```
CALC:MARK:FUNC:POW:RES:PHZ ON|OFF
```

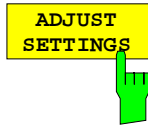

The *ADJUST SETTINGS* softkey automatically optimizes the instrument settings for the selected power measurement (see below).

All instrument settings relevant for a power measurement within a specific frequency range (channel bandwidth) are optimized for the selected channel configuration (channel bandwidth, channel spacing):

- Frequency span:

The frequency span should cover at least all channels to be considered in a measurement.

For channel power measurements, the frequency span is set as follows:

$$(\text{No. of transmission channels} - 1) \times \text{transmission channel spacing} + 2 \times \text{transmission channel bandwidth} + \text{measurement margin}$$

For adjacent-channel power measurements, the frequency span is set as a function of the number of transmission channels, the transmission channel spacing, the adjacent-channel spacing, and the bandwidth of one of adjacent-channels ADJ, ALT1 or ALT2, whichever is furthest away from the transmission channels:

$$(\text{No. of transmission channels} - 1) \times \text{transmission channel spacing} + 2 \times (\text{adjacent-channel spacing} + \text{adjacent-channel bandwidth}) + \text{measurement margin}$$

The measurement margin is approx. 10% of the value obtained by adding the channel spacing and the channel bandwidth.

- Resolution bandwidth $RBW \leq 1/40$ of channel bandwidth
- Video bandwidth $VBW \geq 3 \times RBW$
- Detector RMS detector

Trace math and trace averaging functions are switched off. The reference level is not influenced by *ADJUST SETTINGS*. It can be separately adjusted with *ADJUST REF LVL*.

The adjustment is carried out only once; if necessary, the instrument settings can be changed later.

IEC/IEEE-bus command:

```
SENS:POW:ACH:PRES ACP|CPOW|MCAC|OBW
```

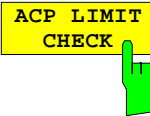

The *ACP LIMIT CHECK* softkey switches the limit check for the ACP measurement on and off.

IEC/IEEE-bus command: `CALC:LIM:ACP ON`
 `CALC:LIM:ACP:ACH:RES?`
 `CALC:LIM:ACP:ALT:RES?`

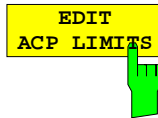

The *EDIT ACP LIMITS* softkey opens a table for defining the limits for the ACP measurement.

ACP LIMITS				
CHAN	RELATIVE LIMIT CHECK		ABSOLUTE LIMIT CHECK	
	VALUE	ON	VALUE	ON
ADJ	-45 dB	✓		
ALT1	-60 dB	✓		
ALT2				

The following rules apply for the limits:

- A separate limit can be defined for each adjacent channel. The limit applies to both the upper and the lower adjacent channel.
- A relative and/or absolute limit can be defined. The check of both limit values can be activated independently.
- The R&S ESCI checks adherence to the limits irrespective of whether the limits are absolute or relative or whether the measurement is carried out with absolute or relative levels. If both limits are active and if the higher of both limit values is exceeded, the measured value is marked accordingly.

Note: *Measured values exceeding the limit are marked by a preceding asterisk.*

IEC/IEEE-bus command:

```

CALC:LIM:ACP ON
CALC:LIM:ACP:ACH 0dB,0dB
CALC:LIM:ACP:ACH:STAT ON
CALC:LIM:ACP:ACH:ABS -10dBm,-10dBm
CALC:LIM:ACP:ACH:ABS:STAT ON
CALC:LIM:ACP:ALT1 0dB,0dB
CALC:LIM:ACP:ALT1:STAT ON
CALC:LIM:ACP:ALT1:ABS -10dBm,-10dBm
CALC:LIM:ACP:ALT1:ABS:STAT ON
CALC:LIM:ACP:ALT2 0dB,0dB
CALC:LIM:ACP:ALT2:STAT ON
CALC:LIM:ACP:ALT2:ABS -10dBm,-10dBm
CALC:LIM:ACP:ALT2:ABS:STAT ON
  
```

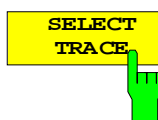

The *SELECT TRACE* softkey selects the trace on which the CP/ACP measurement is to be performed. Only activated traces can be selected, i.e. traces not set to BLANK.

IEC/IEEE-bus command: `SENS:POW:TRAC 1`

Examples:**1. Measurement of adjacent-channel power for a specific standard:**

The adjacent-channel power is to be measured for a signal at 800 MHz with 0 dBm level in line with IS136.

[PRESET]	Set the R&S ESCI to the default setting.
[FREQ: CENTER: 800 MHz]	Set the center frequency to 800 MHz.
[AMPT: 0 dBm]	Set the reference level to 0 dBm.
[MEAS]	Call the menu for the measurement functions.
[CHAN PWR / ACP]	Select the channel and adjacent-channel power measurement function. The measurement is performed with the default settings or a previously defined setting. The submenu for setting the desired new configuration is opened.
[CP/ACP STANDARD: select IS136: ENTER]	Select the NADC (IS136) standard.
[CP/ACP CONFIG]	Call the submenu for configuration of the adjacent-channel power measurement.
[NO. OF ADJ CHAN: 2 ENTER]	Select two adjacent channels for the measurement, i.e. the adjacent channel and the alternate channel are measured.
[ADJUST SETTINGS]	Set the optimum span, resolution bandwidth (RBW), video bandwidth (VBW) and detector automatically for the measurement. The absolute channel power and the relative power of the adjacent channels are displayed on the screen.
	Change to the main menu for channel power measurement.
[ADJUST REF LVL]	Set the reference level equal to the channel power measured.

2. Measurement with user-specific channel configuration:

Measurement of the adjacent-channel power ratio (ACPR) of an IS95 CDMA signal at 800 MHz, level 0 dBm. Similar to example 1, the setting can be simplified by using *CP/ACP STANDARD*.

[PRESET] Set the R&S ESCI to the default setting.

[FREQ: CENTER: 800 MHz] Set the center frequency to 800 MHz.

[AMPT: 0 dBm] Set the reference level to 0 dBm.

[MEAS] Call the menu for the measurement functions.

[CHAN PWR / ACP] Select the channel and adjacent-channel power measurement function. The measurement is carried out with the default settings or a previously defined setting. The submenu for setting the desired new configuration is opened.

[CP/ACP CONFIG] Call the submenu for defining the channel configuration.

[NO. OF ADJ CHAN: 2 ENTER] Select two adjacent channels for the measurement, i.e. the adjacent channel and the alternate channel are measured.



[CHANNEL BANDWIDTH:

1.23 MHz: : 30 kHz] Set the channel bandwidth to 1.23 MHz in accordance with IS 95. Set the adjacent-channel bandwidth to 30 kHz.

TX/ACP CHANNEL BW	
CHAN	BANDWIDTH
TX	1.23 MHz
ADJ	30 kHz
ALT1	30 kHz
ALT2	30 kHz

Upon entry of 30 kHz for the adjacent channel the alternate channels are also set to 30 kHz.

[CHAN SPACING:

1.25 MHz: 
 885 kHz: 
 -1.98 MHz] 
 2.97 MHz]

Open the list for entering the channel spacings.

TX/ACP CHAN SPACING	
CHAN	SPACING
TX	1.25 MHz
ADJ	885 kHz
ALT1	1.98 MHz
ALT2	2.97 MHz

Upon entry of 885 kHz for the adjacent channel the channels ALT1 and ALT2 are set to 1770 kHz and 2655 kHz. Upon entry of 1.98 MHz for the alternate channel 1 the alternate channel 2 is set to 2.97 MHz.

[ADJUST SETTINGS] Automatically set the optimum span (= 5 MHz), resolution bandwidth (RBW = 30 kHz), video bandwidth (VBW = 300 kHz) and detector (RMS) for the measurement. The absolute channel power and the relative power of the adjacent channels and alternate channels are displayed on the screen.



Go to the main menu for channel power measurement.

[ADJUST REF LVL] Set the reference level equal to the channel power measured.

3. Measurement of signal/noise power density (C/No) of an IS95 CDMA signal (frequency 800 MHz, level 0 dBm)

[PRESET]	Set the R&S ESCI to the default setting.
[FREQ: CENTER: 800 MHz]	Set the center frequency to 800 MHz.
[AMPT: 0 dBm]	Set the reference level to 0 dBm.
MEAS]	Call the menu for the measurement functions.
[CHAN PWR / ACP]	Select the channel and adjacent-channel power measurement. The measurement is performed with the default setting or a previously defined setting. The submenu for setting the desired new configuration is opened.
[CP/ACP CONFIG]	Call the submenu for defining the channel configuration.
[NO. OF ADJ CHAN: 0 ENTER]	Do not select an adjacent channel for the measurement, i.e. the measurement is carried out in one channel only.
[CHANNEL BANDWIDTH: 1.23 MHz]	Set the channel bandwidth to 1.23 MHz in line with IS95.
[ADJUST SETTINGS]	Set the optimum span (= 5 MHz), resolution bandwidth (RBW = 30 kHz), video bandwidth (VBW = 300 kHz) and detector (RMS) for the measurement automatically. The absolute channel power and the relative power of the adjacent channels and alternate channels are displayed on the screen.
	Go to the main menu for channel power measurement
[ADJUST REF LVL]	Set the reference level equal to the channel power measured.
[SET CP REFERENCE]	Set the measured channel power as a reference for the subsequent measurements.
[CP/ACP ABS / REL]	Select relative measurement related to the reference power set with SET REFERENCE (result 0 dB).
[CHAN PWR / HZ]	Select power measurement related to 1 Hz bandwidth (result -60.9 dB).
[FREQ: CENTER: 805 MHz]	Set the center frequency to 805 MHz. The R&S ESCI measures the channel power at 1.23 MHz bandwidth and outputs the result in dB relative to the reference power and 1 Hz bandwidth.

Measurement of Occupied Bandwidth

An important characteristics of a modulated signal is its occupied bandwidth. In a radio communications system for instance the occupied bandwidth must be limited to enable distortion-free transmission in adjacent channels. The occupied bandwidth is defined as the bandwidth containing a defined percentage of the total transmitted power. A percentage between 10% and 99.9% can be set on the R&S ESCI.

MEAS OCCUPIED BANDWIDTH menu:

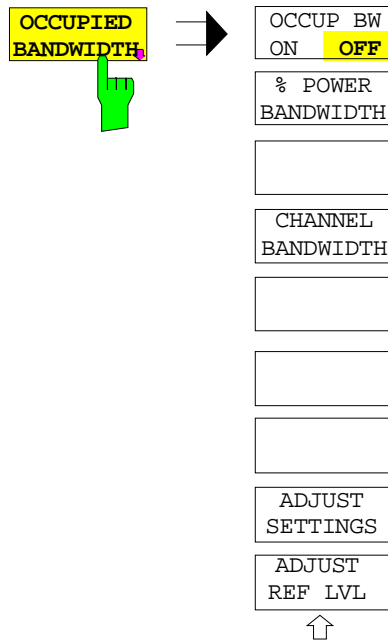

The *OCCUPIED BANDWIDTH* softkey activates measurement of the occupied bandwidth according to the current configuration and opens the submenu for configuring the measurement. The softkey is available only in frequency domain ($\text{span} > 0$) and is highlighted when the measurement is switched on.

In the spectrum display mode, this measurement determines the bandwidth that contains a predefined percentage of the power of the displayed frequency range (*% POWER BANDWIDTH* softkey). The occupied bandwidth is output in the marker display field and marked on the trace by temporary markers.

Note:

- The softkey is only available in the frequency domain ($\text{span} > 0$).
- The measurement is performed on the trace with marker 1. In order to evaluate another trace, marker 1 must be placed on another trace by means of *SELECT TRACE* in the *MKR* menu

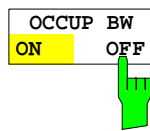

The *OCCUP BW ON/OFF* softkey switches measurement of the occupied bandwidth on or off.

IEC/IEEE-bus command: `CALC:MARK:FUNC:POW:SEL OBW`
`CALC:MARK:FUNC:POW:RES? OBW`
`CALC:MARK:FUNC:POW OFF`

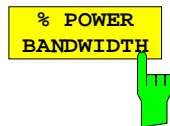

The *% POWER BANDWIDTH* softkey opens the entry of the percentage of power related to the total power in the displayed frequency range which defines the occupied bandwidth (percentage of total power). The valid range of values is 10% to 99.9%.

IEC/IEEE-bus command: `SENS:POW:BWID 99PCT`

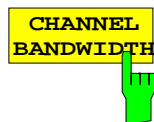

The *CHANNEL BANDWIDTH* softkey opens an input window for defining the channel bandwidth for the transmission channel. For measurements in line with a specific transmission standard, the bandwidth specified by the standard for the transmission channel must be entered.

The default setting is 14 kHz.

The specified channel bandwidth is used for optimization of the test parameters of the R&S ESCI with *ADJUST SETTINGS*.

IEC/IEEE-bus command: `SENS:POW:ACH:BWID 14kHz`

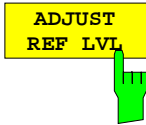

The *ADJUST REF LVL* softkey adjusts the reference level of the R&S ESCI to the measured total power of the signal. The softkey is activated after the first sweep with the measurement of the occupied bandwidth has been completed and the total power of the signal is thus known.

Adjusting the reference level ensures that the signal path of the R&S ESCI will not be overloaded and the dynamic range not limited by too low a reference level.

Since the measurement bandwidth for channel power measurements is significantly lower than the signal bandwidth, the signal path may be overloaded although the trace is distinctly below the reference level. If the measured channel power is equal to the reference level, the signal path cannot be overloaded.

IEC/IEEE-bus command: `SENS:POW:ACH:PRES:RLEV`

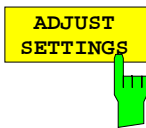

The *ADJUST SETTINGS* softkey optimizes the instrument settings for the measurement of the occupied bandwidth according to the specified channel bandwidth.

All instrument settings relevant for power measurement within a specific frequency range, such as

- frequency span 3 x channel bandwidth
- resolution bandwidth $RBW \leq 1/40$ of channel bandwidth
- video bandwidth $VBW \geq 3 \times RBW$
- detector RMS

are optimized.

The reference level is not influenced by *ADJUST SETTINGS*. For an optimum dynamic range it should be selected in a way that the signal maximum is close to the reference level.

The adjustment is carried out only once; if necessary, the instrument settings may be changed later.

IEC/IEEE-bus command: `SENS:POW:PRES:OBW`

Measurement principle:

For example, the bandwidth containing 99% of the signal power is to be determined. The routine first calculates the total power of all displayed points of the trace. In the next step, the points from the right edge of the trace are summed up until 0.5% of the total power is reached. Auxiliary marker 1 is positioned at the corresponding frequency. Then the R&S ESCI sums up the points from the left edge of the trace until 0.5% of the power is reached. Auxiliary marker 2 is positioned at this point. 99% of the power is now between the two markers. The distance between the two frequency markers is the occupied bandwidth which is displayed in the marker info field.

A prerequisite for correct measurement is that only the signal to be measured is visible on the screen of the R&S ESCI. An additional signal would invalidate the measurement.

To ensure correct power measurement especially for noise signals and to obtain the correct occupied bandwidth, the following settings should be selected:

RBW	<< occupied bandwidth (approx. 1/20 of occupied bandwidth, for voice communication type. 300 Hz or 1 kHz)
VBW	$\geq 3 \times$ RBW
Detector	RMS or sample
Span	≥ 2 to $3 \times$ occupied bandwidth

Some of the measurement specifications (e.g. PDC, RCR STD-27B) require measurement of the occupied bandwidth using a peak detector. The detector setting of the R&S ESCI has to be changed accordingly then.

Example:

Measurement of occupied bandwidth of a PDC signal at 800 MHz, level 0 dBm

[PRESET]	Set the R&S ESCI to the default setting.
[FREQ: CENTER: 800 MHz]	Set the center frequency to 800 MHz.
[AMPT: 0 dBm]	Set the reference level to 0 dBm.
[MEAS]	Call the menu for the measurement functions.
[OCCUPIED BANDWIDTH]	Select measurement of the occupied bandwidth and open the submenu for configuring the measurement.
[% POWER BANDWIDTH: 99 %]	Select 99% for the bandwidth to be measured.
[CHANNEL BANDWIDTH: 21 kHz]	Enter the channel bandwidth of 21 kHz specified by PDC.
[ADJUST SETTINGS]	Optimize the measurement parameters for the specified channel bandwidth. Allow for a complete frequency sweep so that the R&S ESCI can determine the total signal power.
[ADJUST REF LVL]	Adjust the reference level to the measured signal power.
[TRACE: DETECTOR: DETECTOR MAX PEAK]	PDC requires measurement of the occupied bandwidth using a peak detector. Therefore, switch on the peak detector instead of the RMS detector selected by ADJUST SETTINGS.

Measurement of Signal Amplitude Statistics

Digital modulated signals are similar to white noise within the transmit channel, but are different in their amplitude distribution. In order to transmit the modulated signal without distortion all amplitudes of the signal have to be transmitted linearly, e. g. from the output power amplifier. Most critical are the peak amplitude values, of course.

Degradation in transmit quality caused by a transmitter two port network is dependent on the amplitude of the peak values as well as on their probability.

The probability of amplitude values can be measured with the APD function (Amplitude Probability Distribution). During a selectable measurement time all occurring amplitude values are assigned to an amplitude range. The number of amplitude values in the specific ranges is counted and the result is displayed as a histogram. Each bar of the histogram represents the percentage of measured amplitudes within the specific amplitude range.

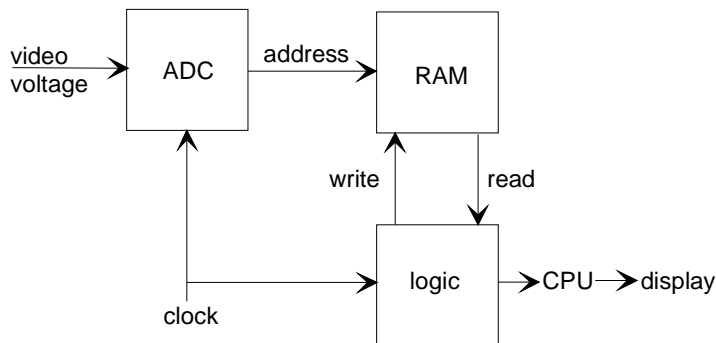

Fig. 4-16 Simplified block diagram for APD measurement

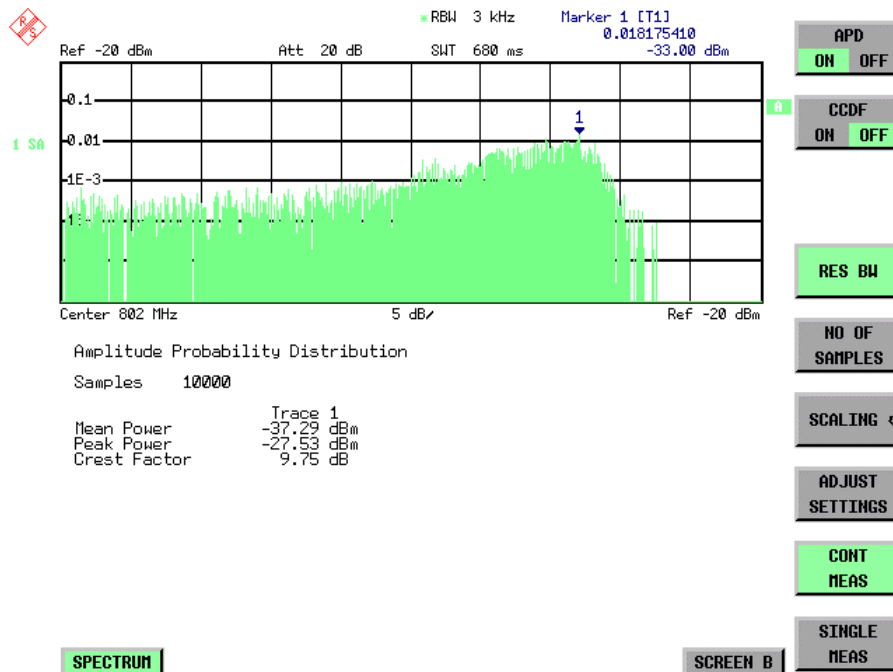

Fig. 4-17 Display of the amplitude probability distribution

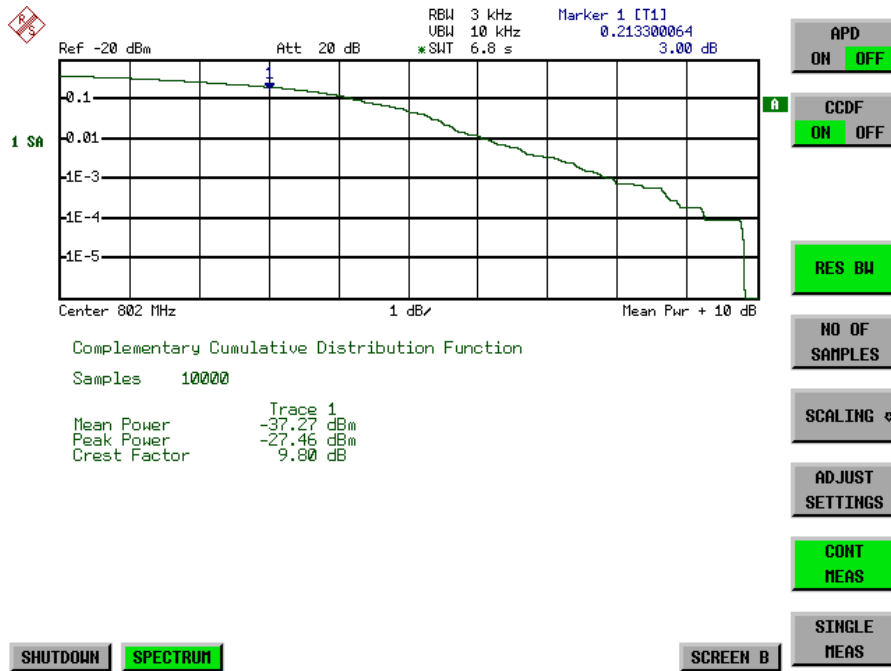

Fig. 4-18 Display of the complementary cumulative distribution function (CCDF)

Alternate to the histogram display of the APD the Complementary Cumulative Distribution Function (CCDF) can be displayed. It shows the probability of an amplitude exceeding a specific value. For the APD function the x-axis is scaled in absolute values in dBm, whereas for the CCDF function the x-axis is scaled relative to the MEAN POWER measured.

Definitions:

Crest factor = peak voltage to rms

CCDF = complementary cumulative distribution function

Note: During an active statistic measurement the functions FULL SCREEN, SPLIT SCREEN and selection of the active diagram via SCREEN A / SCREEN B are disabled.

MEAS SIGNAL STATISTIC submenu :

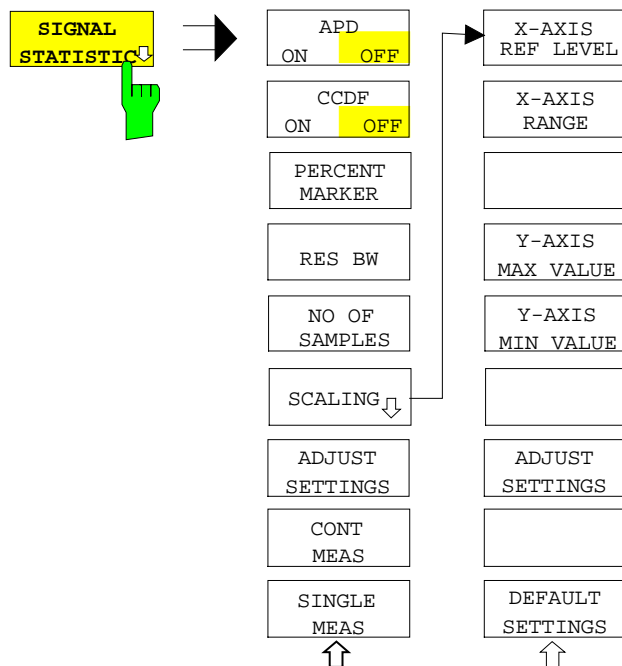

The *SIGNAL STATISTIC* softkey opens a submenu for measurement of signal statistics.

In the submenu measurement of amplitude probability density (*APD*) and complementary cumulative distribution (*CCDF*) can be selected alternately. Only one of the signal statistic functions can be switched on at a time.

In default mode all statistic functions are switched off.

With a statistic function switched on the R&S ESCI is set into zero span mode automatically.

The R&S ESCI measures the statistics of the signal applied to the RF input with the resolution bandwidth set. In order not to influence the peak amplitudes the video bandwidth is automatically set to 10 times the resolution bandwidth. The sample detector is used for detecting the video voltage.

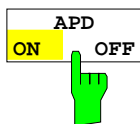

The *APD ON/OFF* softkey switches on or off the amplitude probability distribution function.

When the *APD* function is switched on, the *CCDF* function is switched off automatically.

IEC/IEEE-bus command: `CALC:STAT:APD ON`

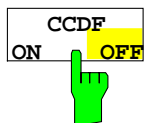

The *CCDF ON/OFF* softkey switches on or off the complementary cumulative distribution function.

When the *CCDF* function is switched on, the *APD* function is switched off automatically.

IEC/IEEE-bus command: `CALC:STAT:CCDF ON`

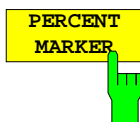

If the *CCDF* function is active, the *PERCENT MARKER* softkey allows to position marker 1 by entering a probability value. Thus, the power which is exceeded with a given probability can be determined very easily.

If marker 1 is in the switched-off state, it will be switched on automatically.

IEC/IEEE-bus command: `CALC:MARK:Y:PERC 0...100%`

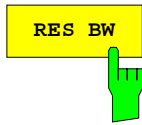

The *RES BW* softkey sets the resolution bandwidth in the menu *STATISTIC FUNCTION* directly without switching to the corresponding menu (*BW*). The function of the softkey is identical to the softkey *RES BW MANUAL* in the menu *BW*.

For correct measurement of the signal statistics the resolution bandwidth has to be wider than the signal bandwidth in order to transmit the actual peaks of the signal amplitude correctly. Video bandwidth is set to 10 MHz automatically with a statistic function switched on.

IEC/IEEE-bus command: BAND 3 MHz

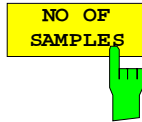

The *NO OF SAMPLES* softkey sets the number of power measurements taken into account for the statistics.

Please note that the overall measurement time is influenced by the number of samples selected as well as by the resolution bandwidth set up for the measurement as the resolution bandwidth directly influences the sampling rate.

IEC/IEEE-bus command: CALC:STAT:NSAM <value>

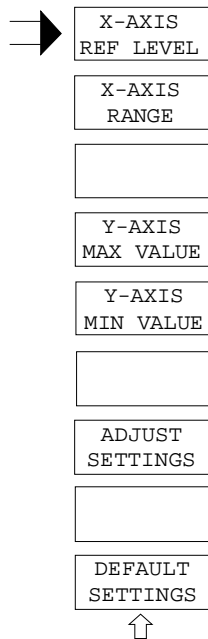
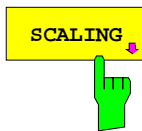

The *SCALING* softkey opens a sub menu that allows changing the scaling parameters for both the x- and the y-axis.

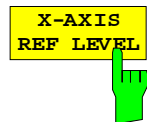

The *X-AXIS REF LEVEL* softkey changes the level settings of the instrument and sets the maximum power to be measured.

The function is identical to softkey *REF LEVEL* in menu *AMPT*. For the *APD* function this value is mapped to the right diagram border. For the *CCDF* function there is no direct representation of this value on the diagram as the x-axis is scaled relatively to the *MEAN POWER* measured.

IEC/IEEE command: CALC:STAT:SCAL:X:RLEV <value>



X-AXIS
RANGE

The *X-AXIS RANGE* softkey changes the level range to be covered by the statistics measurement selected. The function is identical to softkey *RANGE LOG MANUAL* in menu *AMPT*.

IEC/IEEE command: `CALC:STAT:SCAL:X:RANG <value>`

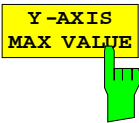

Y-AXIS
MAX VALUE

The *Y-AXIS MAX VALUE* softkey defines the upper limit of the displayed probability range. Values on the y-axis are normalized which means that the maximum value is 1.0. As the y-axis scaling has a logarithmic axis the distance between max and min value must be at least one decade.

IEC/IEEE command: `CALC:STAT:SCAL:Y:UPP <value>`



Y-AXIS
MIN VALUE

The *Y-AXIS MIN VALUE* softkey defines the lower limit of the displayed probability range. As the y-axis scaling has a logarithmic axis the distance between max and min value must be at least one decade. Valid values are in the range $0 < \text{value} < 1$.

IEC/IEEE command: `CALC:STAT:SCAL:Y:LOW <value>`

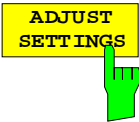

ADJUST
SETTINGS

see below

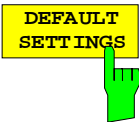

DEFAULT
SETTINGS

The *DEFAULT SETTINGS* softkey resets the x- and y-axis scalings to their PRESET values.

x-axis ref level: -20 dBm
x-axis range APD: 100 dB
x-axis range CCDF: 20 dB

y-axis upper limit: 1.0
y-axis lower limit: 1E-6

IEC/IEEE-bus command: `CALC:STAT:PRES`

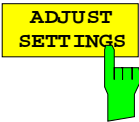

ADJUST
SETTINGS

The *ADJUST SETTINGS* softkey optimizes the level settings of the R&S ESCI according to the measured peak power in order to gain maximum sensitivity of the instrument.

The level range is adjusted according to the measured difference between peak and minimum power for APD measurement and peak and mean power for CCDF measurement in order to obtain maximum power resolution. Additionally the probability scale is adapted to the selected number of samples.

IEC/IEEE-bus command: `CALC:STAT:SCAL:AUTO ONCE`

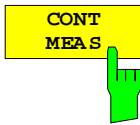

The *CONT MEAS* softkey starts collecting a new sequence of sample data and calculating the APD or CCDF curve depending on the selected measurement. The next measurement is started automatically as soon as the indicated number of samples has been reached ("CONTinuous MEASurement").

IEC/IEEE-bus command: INIT:CONT ON ;
 INIT:IMM

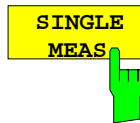

The *SINGLE MEAS* softkey starts collecting a new sequence of sample data and calculating the APD or CCDF curve depending on the selected measurement. At the beginning of the measurement previously obtained measurement results are discarded.

IEC/IEEE-bus command: INIT:CONT OFF ;
 INIT:IMM

Hint for usage of the marker functions with measurement of signal statistics:

With the signal statistic measurement level always is displayed on x-axis. Y-axis always is a normalized value between 0 and 1. In contrary to use of marker in frequency or time domain marker is input in level values and the output is in percentage values.

Example:

Measurement of CCDF of a IS95 BTS signal, level 0 dBm, frequency 800 MHz

[PRESET]	Switch on preset settings.
[FREQ: CENTER: 800 MHz]	Set center frequency to 800 MHz.
[AMPT: 10 dBm]	Set reference level to 10 dBm.
[BW: 3 MHz]	Set resolution bandwidth to 3 MHz (resolution bandwidth shall be wider than signal bandwidth (1.25 MHz) in order to have the complete signal within the resolution bandwidth).
[MEAS]	Call the menu for measurement functions.
[SIGNAL STATISTIC]	Call the menu for signal statistics measurement.
[CCDF ON/OFF]	Switch on measurement of the complementary cumulative distribution function. The R&S ESCI switches to zero span mode. The power of the signal and the CCDF is calculated for the number of samples selected. With the CCDF function sample detector and video bandwidth are set automatically.
[NO OF SAMPLES: 10000]	Set the number of measurement samples to 10000.
[SINGLE MEAS]	Start the measurement sequence. At the end the resulting trace will display the CCDF for the measured 10000 samples.

Measurement of Carrier/Noise Ratio C/N and C/N₀

Using the carrier/noise measurement function, the R&S ESCI determines the C/N ratio which can also be shown normalized to a 1 Hz bandwidth (function C/N₀).

To determine the noise power, a channel at the set center frequency is examined. The bandwidth of the channel is fixed by means of the CHANNEL BANDWIDTH function.

The largest signal in the frequency span is the carrier. It is searched when the function is activated and is marked by means of the REFERENCE FIXED marker. The noise power of the channel is subtracted from the signal level obtained (C/N), and in the case of a C/N₀ measurement it is referred to a 1 Hz bandwidth.

There are two methods for measuring the carrier/noise ratio:

1. The carrier is outside the channel examined:

In this case, it is sufficient to switch on the desired measurement function and to set the channel bandwidth. The carrier/noise ratio is displayed on the screen.

2. The carrier is inside the channel examined:

In this case, the measurement must be performed in two steps. First, the reference measurement is performed with the carrier being active. This is done by switching on either the C/N or the C/N₀ measurement and waiting for the end of the next measurement run. Then, the carrier is switched off so that only the noise of the test setup is active in the channel. The carrier/noise ratio is displayed after the subsequent measurement has been completed.

The ADJUST SETTINGS function facilitates the selection of the frequency span appropriate for the channel bandwidth: it automatically sets the SPAN to approx. 4 x channel bandwidth.

The RMS detector is enabled when the power measurement is switched on (TRACE-DETECTOR-RMS).

Submenu MEAS – C/N, C/N₀:

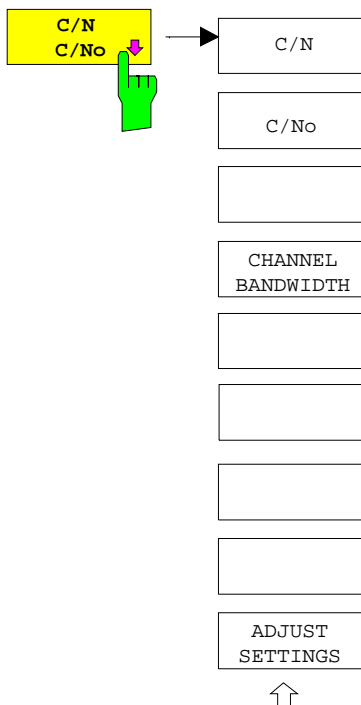

The C/N, C/No softkey opens the submenu for configuring the carrier/noise ratio measurement.

The user can choose between measurement without (C/N) and measurement with reference to the bandwidth (C/No). In addition, it is possible to select the bandwidth of the channel and to adapt the span.

Note:

The measurements are only available in the frequency domain (span >0).

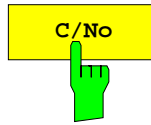
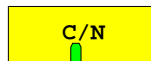

The *C/N* and *C/No* softkeys enable and disable the measurement of the carrier/noise ratio, the *C/No* measurement also being referred to a 1 Hz bandwidth.

The maximum value of the current trace is determined when the function is activated and is marked by means of the *REFERENCE FIXED* marker.

Note: *The measurement is performed on the trace where MARKER 1 is located. To measure another trace, MARKER 1 has to be shifted to the trace in question using the SELECT TRACE softkey in the MKR menu.*

If no marker is active, MARKER 1 is activated when the function is switched on.

IEC/IEEE-bus command: `CALC:MARK:FUNC:POW:SEL CN`
`CALC:MARK:FUNC:POW:RES? CN`
`CALC:MARK:FUNC:POW:SEL CNO`
`CALC:MARK:FUNC:POW:RES? CNO`
`CALC:MARK:FUNC:POW OFF`

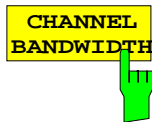

The *CHANNEL BANDWIDTH* softkey opens a window for selecting the measurement channel bandwidth.

The default setting is 14 kHz.

The specified channel bandwidth allows the optimal setting of the measurement parameters of the FSP using *ADJUST SETTINGS*.

IEC/IEEE-bus command: `SENS:POW:ACH:BWID 14kHz`

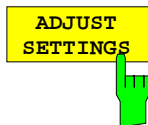

The *ADJUST SETTINGS* softkey adapts the span to the channel bandwidth selected.

For the carrier/noise ratio measurement, the span is set to:

$4 \times \text{channel bandwidth} + \text{measurement margin}$

The adjustment is performed once; if necessary, the setting can be changed later on.

IEC/IEEE-bus command: `SENS:POW:ACH:PRES CN | CNO`

Measurement of the AM Modulation Depth

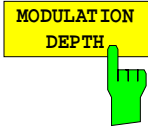

The *MODULATION DEPTH* softkey switches on the measurement of the AM modulation depth. An AM-modulated carrier is required on the screen for ensuring correct operation.

The level value of *MARKER 1* is taken as the carrier level. When this function is activated, *MARKER 2* and *MARKER 3* are automatically set symmetrically to the carrier on the adjacent peak values of the trace as delta markers and *MARKER 2* is activated for the entry.

When the position of *MARKER 2* (delta) is changed, *MARKER 3* (delta) is moved symmetrically with respect to the reference marker (*MARKER 1*).

If the data entry is activated for *MARKER 3* (*MARKER 1 2 3 4* softkey), the latter can be moved for fine adjustment irrespective of *MARKER 2*.

The R&S ESCI calculates the power at the marker positions from the measured levels. The AM modulation depth is calculated from the ratio between the power values at the reference marker and at the delta markers. When the powers of the two AM side bands are unequal, the mean value of the two power values is used for AM modulation depth calculation.

Measurement example:

The AM modulation depth of a carrier modulated with 1 kHz is to be measured at 100 MHz.

[PRESET]	The R&S ESCI is set to the default setting.
[CENTER: 100 MHz]	The center frequency is set to 100 MHz.
[SPAN: 5 kHz]	The span is set to 5 kHz.
[AMPT: 0 dBm]	The reference level is set to 0 dBm.
[MKR FCTN]	<i>MARKER 1</i> is switched on and positioned at the maximum of the displayed trace.
[MODULATION DEPTH: 1 kHz]	The measurement of the AM modulation depth is switched on. <i>MARKERS 2</i> and <i>3</i> (delta markers) are set to the adjacent peak values of the trace and are activated for the frequency entry. The AM modulation depth is output in % in the marker info field. When 1 kHz is entered, <i>MARKER 2</i> can be exactly positioned on 1 kHz and <i>MARKER 3</i> at -1 kHz from the reference marker.

IEC/IEEE-bus command: `CALC:MARK:FUNC:MDEP ON;`
 `CALC:MARK:FUNC:MDEP:RES?`

Measurement of the Third Order Intercept (TOI)

If several signals are applied to a transmission twoport device with nonlinear characteristic, intermodulation products appear at its output by the sums and differences of the signals. The nonlinear characteristic produces harmonics of the useful signals which intermodulate at the characteristic. The intermodulation products of lower order have a special effect since their level is largest and they are near the useful signals. The intermodulation product of third order causes the highest interference. It is the intermodulation product generated from one of the useful signals and the 2nd harmonic of the second useful signal in case of two-tone modulation.

The frequencies of the intermodulation products are above and below the useful signals. Fig. 4-19 shows intermodulation products P_{I1} and P_{I2} generated by the two useful signals P_{U1} and P_{U2} .

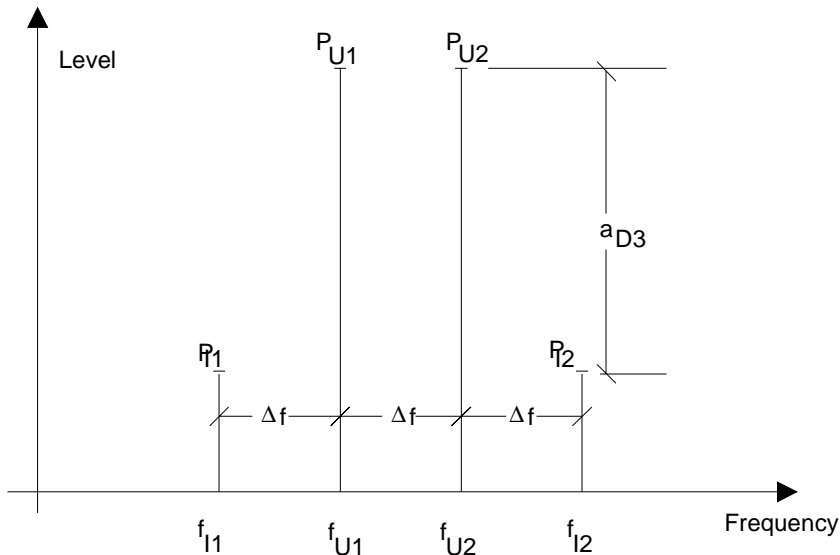

Fig. 4-19 Intermodulation products P_{U1} and P_{U2}

The intermodulation product at f_{I2} is generated by mixing the 2nd harmonic of useful signal P_{U2} and signal P_{U1} , the intermodulation product at f_{I1} by mixing the 2nd harmonic of useful signal P_{U1} and signal P_{U2} .

$$f_{I1} = 2 \times f_{U1} - f_{U2} \quad (1)$$

$$f_{I2} = 2 \times f_{U2} - f_{U1} \quad (2)$$

The level of the intermodulation products depends on the level of the useful signals. If the two useful signals are increased by 1 dB, the level of the intermodulation products increases by 3 dB, which means that spacing a_{D3} between intermodulation signals and useful signals is reduced by 2 dB. This is illustrated in Fig. 4-20.

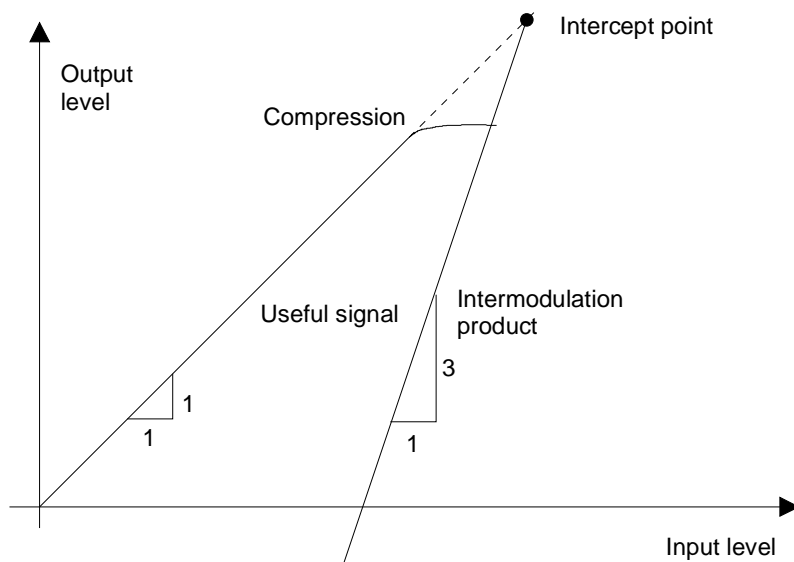

Fig. 4-20 Dependence of intermodulation level on useful signal level

The useful signals at the twoport output increase proportionally with the input level as long as the twoport is in the linear range. A level change of 1 dB at the input causes a level change of 1 dB at the output. Beyond a certain input level, the twoport goes into compression and the output level stops increasing. The intermodulation products of the third order increase three times as much as the useful signals. The intercept point is the fictitious level where the two lines intersect. It cannot be measured directly since the useful level is previously limited by the maximum twoport output power. It can be calculated from the known line slopes and the measured spacing a_{D3} at a given level according to the following formula.

$$IP3 = \frac{a_{D3}}{2} + P_N \quad (3)$$

The 3rd order intercept point (TOI), for example, is calculated for an intermodulation of 60 dB and an input level P_U of -20 dBm according to the following formula:

$$IP3 = \frac{60}{2} + (-20\text{dBm}) = 10\text{dBm}. \quad (4)$$

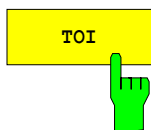

The *TOI* softkey enables the measurement of the 3rd order intercept point. A two-tone signal with equal carrier levels is expected at the R&S ESCI input. *MARKER 1* and *MARKER 2* (both normal markers) are set to the maximum of the two signals. *MARKER 3* and *MARKER 4* (both delta markers) are placed on the intermodulation products. When the function is enabled, the frequency entry is activated for the delta markers. They can be set manually. The R&S ESCI calculates the third order intercept from the level spacing between normal markers and delta markers and outputs it in the marker info field.

IEC/IEEE-bus command: `CALC:MARK:FUNC:TOI ON;`
 `CALC:MARK:FUNC:TOI:RES?`

Example:

A two-tone signal with frequencies of 100 MHz and 101 MHz is applied to the RF input of the R&S ESCI. The level of the two signals is -10 dBm.

[PRESET]	The R&S ESCI is set to the default setting.
[CENTER: 100.5 MHz]	The center frequency is set to 100.5 MHz.
[SPAN: 3 MHz]	The span is set to 3 MHz.
[AMPT: -10 dBm]	The reference level is set to -10 dBm.
[MKR FCTN]	MARKER 1 is switched on and set to the signal peak.
[TOI]	The R&S ESCI sets the 4 markers to the useful signals and the intermodulation products and calculates the third order intercept. The result is output in the marker info field.

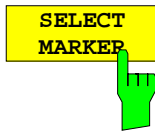

The *SELECT MARKER* softkey activates the selection of a marker for functions *MODULATION DEPTH* and *TOI*. Thus, the markers can be fine-adjusted for these functions.

The markers are numerically selected in a data entry field. Delta marker 1 is selected by entering '0'.

If the marker is in the switch-off state, it will be switched on and can thus be shifted.

IEC/IEEE-bus command:	CALC:MARK1 ON;
	CALC:MARK1:X <value>;
	CALC:MARK1:Y?

Setup of Limit Lines and Display Lines – LINES Key

Limit lines are used to define amplitude curves or spectral distribution boundaries on the display screen which are not to be exceeded. They indicate, for example, the upper limits for interference radiation or spurious waves which are allowed from a unit under test (UUT). For transmission of information in TDMA (e.g. GSM), the amplitude of the bursts in a timeslot must adhere to a curve which must fall within a specified tolerance band. The lower and upper limits may each be specified by a limit line. Then, the amplitude curve can be controlled either visually or automatically for any violations of the upper or lower limits (GO/NOGO test).

The instrument supports limit lines with a maximum of 50 data points. 8 of the limit lines stored in the instrument can be used simultaneously and activated in the split-screen mode either in Screen A, Screen B or in the two windows. The number of limit lines stored in the instrument is only limited by the capacity of the flashdisk used.

For each limit line, the following characteristics must be defined:

- The name of the limit line. The limit line data are stored under this name and can be examined in the table *LIMIT LINES*.
- The domain in which the limit line is to be used. Here, a distinction is made between the time domain (span = 0 Hz, analyzer mode only) and the frequency domain (span > 0 Hz).
- The reference of the interpolation points to the X axis. The limit line may be specified either for absolute frequencies or times or for frequencies which are related to the set center frequency and times related to the time on the left edge of the diagram. In receiver mode, only absolute scaling is used.
- The reference of the interpolation points to the Y axis. The limit line can be selected either for absolute levels or voltages or referred to the set maximum level (Ref Lvl). The position on the display depends on the *REF LEVEL POSITION*. In receiver mode, only absolute scaling is used.
- With relative reference values for the Y axis, it is possible to enter an absolute threshold (THRESHOLD) which lowers the relative limit values (see below, analyzer mode only).
- The type of limit line (upper or lower limit, lower limit for analyzer mode only). With this information and the active limit checking function (Table *LIMIT LINES*, *LIMIT CHECK ON*, analyzer mode only), the R&S checks for compliance with each limit.
- The limit line units to be used. The units of the limit line must be compatible with the level axis in the active measurement window.
- The measurement curve (trace) to which the limit line is assigned. For the R&S ESCI, this defines the curve to which the limit is to be applied when several traces are simultaneously displayed.
- For each limit line, a margin can be defined which serves as a threshold for automatic evaluation.
- In addition, commentary can be written for each limit line, e.g. a description of the application.

Display lines are exclusively used to optically mark relevant frequencies or points in time (span = 0) as well as constant level values. It is not possible to check automatically whether the marked level values have been underranged or exceeded.

Selection of Limit Lines

The *LINES* key opens the menu for fixing the limit lines and the display lines.

LINES menu

LIMIT LINES

NAME	COMPATIBLE	LIMIT CHECK	TRACE	MARGIN
√GSM1900UP	√	on	1	0.000 dB
LP1GHZ	√	off	2	0.000 dB
NFSIG		off	3	0.000 dB

The *SELECTED LIMIT LINE* display field provides information concerning the characteristics of the marked limit lines.

In the *LIMIT LINES* table, the limit lines compatible to the settings of the active screen can be enabled.

New limit lines can be specified and edited in the *NEW LIMIT LINE* and *EDIT LIMIT LINE* sub-menus, respectively.

The horizontal and vertical lines of the *DISPLAY LINES* submenu mark individual levels or frequencies (span > 0) or times (span = 0) in the diagram.

The *SELECTED LIMIT LINE* table provides information about the characteristics of the marked limit line :

<i>Name</i>	name
<i>Domain</i>	frequency or time
<i>Unit</i>	vertical scale
<i>X-Axis</i>	interpolation
<i>Limit</i>	upper/lower limit
<i>X-Scaling</i>	absolute or relative frequencies/times
<i>Y-Scaling</i>	absolute or relative Y units
<i>Threshold</i>	absolute limit with relative Y units
<i>Comment</i>	commentary

The characteristics of the limit line are set in the *EDIT LIMIT LINE (=NEW LIMIT LINE)* sub-menu.



The *SELECT LIMIT LINE* softkey activates the *LIMIT LINES* table and the selection bar jumps to the uppermost name in the table.

The following information is offered in the columns of the table:

<i>Name</i>	Enable the limit line.
<i>Compatible</i>	Indicates if the limit line is compatible with the measurement window of the given trace.
<i>Limit Check</i>	Activate automatic violation check for upper/lower limits.
<i>Trace</i>	Select the measurement curve to which the limit is assigned.
<i>Margin</i>	Define margin.

Name and Compatible - Enabling limit lines

A maximum of 8 limit lines can be enabled at any one time. In split screen mode, they may be assigned to screen A, screen B or to both screens. A check mark at the left edge of a cell indicates that this limit line is enabled. A limit line can only be enabled when it has a check mark in the *Compatible* column, i.e. only when the horizontal display (time or frequency) and vertical scales are **identical** to those of the display in the measurement window. Lines with the unit dB are compatible to all dB(..) settings of the Y axis.

If the scale of the y axis or the domain (frequency or time axis) are changed, all non-compatible limit lines are automatically switched off in order to avoid misinterpretation. The limit lines must be enabled anew when the original display is re-displayed.

IEC/IEEE-bus command: `CALC:LIM3:NAME "GSM1"`
 `CALC:LIM3:UPP:STAT ON`
 `CALC:LIM4:LOW:STAT ON`

Limit Check - Activate automatic limit violation check

When *LIMIT CHECK ON* is activated, a GO/NOGO test is performed in the active screen. In the center of the diagram, a display window appears which indicates the results of the limit check test:

LIMIT CHECK: PASSED No violations of active limits.

LIMIT CHECK: FAILED One or more active limit lines were violated. The message contains the names of the limit lines which were violated or whose margins were not complied with.

LIMIT CHECK: MARGIN The margin of at least one active limit lines was not complied with, however, no limit line was violated. The message contains the names of the limit lines whose margins were not complied with.

The following example shows two active limit lines:

```
LIMIT CHECK: FAILED
LINE VHF_MASK: Failed
LINE UHF2MASK: Margin
```

A check for violations of limit lines takes place only if the limit line of the assigned measurement curve (trace) is enabled.

If *LIM CHECK* is set to *OFF* for all active limit lines, then the limit line check is not executed and the display window is activated.

```
IEC/IEEE-bus command:  CALC:LIM:STAT ON
                       INIT;*WAI
                       CALC:LIM:FAIL?
```

Trace - Select the measurement curve to which the limit line is assigned.

The selection of the measurement curve (trace) takes place in an entry window. Allowed are the integer entries 1, 2 or 3. The default setting is trace 1. If the selected limit line is not compatible with the assigned measurement curve, then the limit line is disabled (display and limit check).

```
IEC/IEEE-bus command:  CALC:LIM:TRAC 1
```

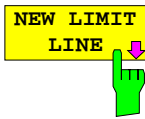

See following Section "Entry and Editing of Limit Lines".

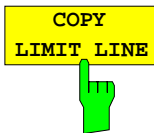
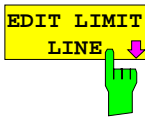

The *COPY LIMIT LINE* softkey copies the data file describing the marked limit line and saves it under a new name. In this way, a new limit line can be easily generated by parallel translation or editing of an existing limit line. The name can be arbitrarily chosen and input via an entry window (max. of 8 characters).

IEC/IEEE-bus command: `CALC:LIM3:COPY 2` or
 `CALC:LIM3:COPY "GSM2"`



The *DELETE LIMIT LINE* softkey erases the selected limit line. Before deletion, a message appears requesting confirmation.

IEC/IEEE-bus command: `CALC:LIM3:DEL`



The *X OFFSET* softkey horizontally shifts a limit line, which has been specified for relative frequencies or times (X axis). The softkey opens an entry window, where the value for shifting may be entered numerically or via the rollkey.

Note: *This softkey does not have any effect on limit lines that represent absolute values for the X axis.*

IEC/IEEE-bus command: `CALC:LIM3:CONT:OFFS 10kHz`



The *Y OFFSET* softkey vertically shifts a limit line, which has relative values for the Y axis (levels or linear units such as volt). The softkey opens an entry window where the value for shifting may be entered numerically or via the rollkey.

Note: *This softkey does not have any effect on limit lines that represent absolute values for the Y axis.*

IEC/IEEE-bus command: `CALC:LIM3:LOW:OFFS 3dB`
 `CALC:LIM3:UPP:OFFS 3dB`

Entry and Editing of Limit Lines



A limit line is characterized by

- its name
- the assignment of domain (frequency or time)
- the scaling in absolute or relative times or frequencies
- the vertical unit
- the interpolation
- the vertical scaling
- the vertical threshold (only with relative vertical scaling)
- the margin
- the definition of the limit line as either upper or lower limit.
- the data points for frequency/time and level

At the time of entry, the R&S ESCI immediately checks that all limit lines are in accordance with certain guidelines. These guidelines must be observed if specified operation is to be guaranteed.

- The frequencies/times for each data point must be entered in ascending order, however, for any single frequency/time, two data points may be input (vertical segment of a limit line).

The data points are allocated in order of ascending frequency/time. Gaps are not allowed. If gaps are desired, two separate limit lines must be defined and then both enabled.

- The entered frequencies/times need not necessarily be selectable in R&S ESCI. A limit line may also exceed the specified frequency or time domains. The minimum frequency for a data point is -200 GHz, the maximum frequency is 200 GHz. For the time domain representation, negative times may also be entered. The valid range is -1000 s to +1000 s.
- The minimum/maximum value for a limit line is -200 dB to +200 dB for the logarithmic or 10^{-20} to 10^{+20} or -99.9% to + 999.9% for the linear amplitude scales.

LINES - EDIT LIMIT LINE menu

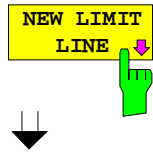
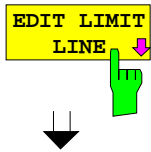

The *EDIT LIMIT LINE* and *NEW LIMIT LINE* softkeys both call the *EDIT LIMIT LINE* sub-menu used for editing limit lines. In the table heading, the characteristics of the limit line can be entered. The data points for frequency/time and level values are entered in the columns.

<i>Name</i>	Enter name.
<i>Domain</i>	Select domain.
<i>Unit</i>	Select units.
<i>X-Axis</i>	Select interpolation
<i>Limit</i>	Select upper and lower limit value.
<i>X-Scaling</i>	Entry of absolute or relative values for the X axis
<i>Y-Scaling</i>	Entry of absolute or relative values for the Y axis
<i>Margin</i>	Entry of margin.
<i>Threshold</i>	Entry of vertical threshold (only with relative vertical scaling)
<i>Comment</i>	Enter comments.
<i>Time/Frequency</i>	Enter time/frequency for the data points.
<i>Limit/dBm</i>	Enter magnitudes for the data points.

Note: *Domain, unit, X scaling and Y scaling cannot be modified as soon as reference values have been entered in the data section of the table.*

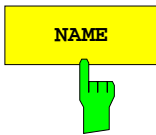

The *NAME* softkey enables the entry of characteristics in the table heading.

Name - Enter name

A maximum of 8 characters is permitted for each name. All names must be compatible with the MS DOS conventions for file names. The instrument stores all limit lines with the .LIM extension.

IEC/IEEE-bus command: `CALC:LIM3:NAME "GSM1"`

Domain - Select time or frequency domain

The default setting is frequency.

Note: *A change in domain (frequency/time) is only permitted when the data point table is empty.*

IEC/IEEE-bus command: `CALC:LIM3:CONT:DOM FREQ`

X Axis - Select interpolation

Linear or logarithmic interpolation can be carried out between the frequency reference points of the table. The ENTER key toggles between LIN and LOG selection.

IEC/IEEE-bus commands CALC:LIM3:CONT:SPAC LIN
 CALC:LIM3:UPP:SPAC LIN
 CALC:LIM3:LOW:SPAC LIN

Scaling - selection of absolute or relative scaling

The limit line can either be scaled in absolute (frequency or time) or relative units. Any of the unit keys may be used to toggle between *ABSOLUTE* and *RELATIVE*, the cursor must be positioned in the *X Scaling* or the *Y Scaling* line.

X-Scaling ABSOLUTE The frequencies or times are interpreted as absolute physical units.

X-Scaling RELATIVE In the data point table, the frequencies are referred to the currently set center frequency. In time domain mode, the left boundary of the diagram constitutes the reference.

Y-Scaling ABSOLUTE The limit values refer to absolute levels or voltages.

Y-Scaling RELATIVE The limit values refer to the reference level (Ref Level) or, in case a reference line is set, to the reference line.
 Limit values with the unit dB are always relative values.

The *RELATIVE* scaling is always suitable, if masks for bursts are to be defined in the time domain, or if masks for modulated signals are required in the frequency domain.

An X offset with half the sweep time may be entered in order to shift the mask in the time domain into the center of screen.

IEC/IEEE-bus command: CALC:LIM3:CONT:MODE ABS
 CALC:LIM3:UPP:MODE ABS
 CALC:LIM3:LOW:MODE ABS

Unit - Select the vertical scale units for the limit line

The selection of units takes place in a selection box. The default setting is dBm.

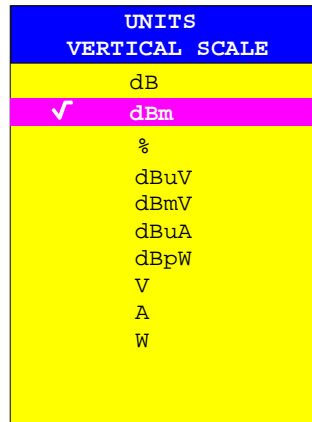

IEC/IEEE-bus command: `CALC:LIM3:UNIT DBM`

Limit - Select upper/lower limit

A limit line can be defined as either an upper or lower limit.

IEC/IEEE-bus command: `--`
 (defined by key words `:UPPER` or `:LOWER`)

Margin - Setting a margin.

The margin is defined as the signal-level distance to the limit line. When the limit line is defined as an upper limit, the margin means that the level is below the limit line. When the limit line is defined as a lower limit, the margin means that the level is above the limit line. The default setting is 0 dB (i.e. no margin).

IEC/IEEE-bus command: `CALC:LIM3:UPP:MARG 10dB`
`CALC:LIM3:LOW:MARG 10dB`

Threshold – Selection of the threshold value with relative Y scaling

With relative Y scaling, an absolute threshold value can be defined which lowers the relative limit values. The function is useful especially for mobile radio applications provided the limit values are defined in relation to the carrier power as long as they are above an absolute limit value.

Example:

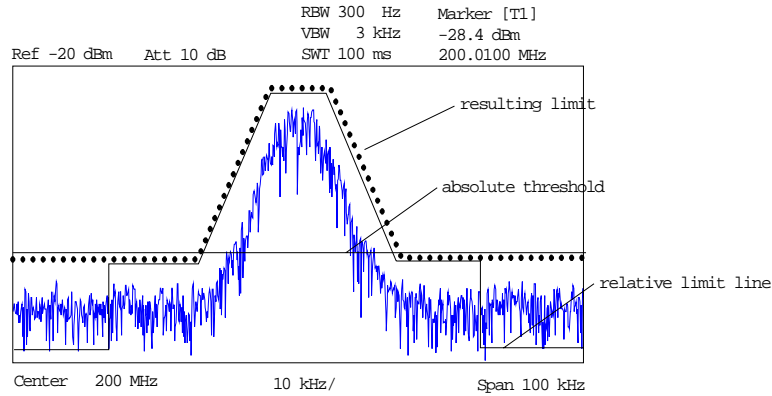

The preset value is at -200 dBm. The field is displayed if the value RELATIVE is entered in the field Y-SCALING.

```
IEC/IEEE-bus command:    CALC:LIM3:UPP:THR -30 dBm
                           OR
                           CALC:LIM3:LOW:THR -30 dBm
```

Comment - Enter comments

Comments are arbitrary, however, they must be less than 41 characters long.

```
IEC/IEEE-bus command:    CALC:LIM3:COMM "Upper limit"
```

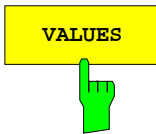

The *VALUES* softkey activates the entry of the data points in the table columns *Time/Frequency* and *Limit/dB*. Which table columns appear depends upon the *Domain* selection in the table heading.

The desired frequency/time data points are entered in ascending order (two repeated frequencies/time values are permitted).

```
IEC/IEEE-bus command:    CALC:LIM3:CONT:DATA 1MHz,3MHz,30MHz
                           CALC:LIM3:UPP:DATA -10,0,0
                           CALC:LIM3:LOW:DATA -30,-40,-40
```

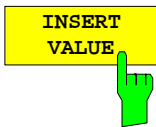

The *INSERT VALUE* softkey creates an empty line above the current cursor position where a new data point may be entered. However, during the entry of new values, it is necessary to observe an ascending order for frequency/time.

```
IEC/IEEE-bus command:    --
```

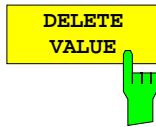

The *DELETE VALUE* softkey erases the data point (complete line) at the cursor position. All succeeding data points are shifted down accordingly.

IEC/IEEE-bus command: --

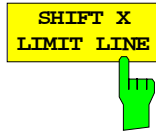

The *SHIFT X LIMIT LINE* softkey calls an entry window where the complete limit line may be shifted parallel in the horizontal direction.

The shift takes place according to the horizontal scale:

- in the frequency domain in Hz, kHz, MHz or GHz
- in the time domain in ns, μ s, ms or s

In this manner, a new limit line can be easily generated based upon an existing limit line which has been shifted horizontally and stored (*SAVE LIMIT LINE* softkey) under a new name (*NAME* softkey).

IEC/IEEE-bus command: CALC:LIM3:CONT:SHIF 50KHz



The *SHIFT Y LIMIT LINE* softkey calls an entry window where the complete limit line may be shifted parallel in the vertical direction.

The shift takes place according to the vertical scale:

- for logarithmic units, relative, in dB
- for linear units, as a factor

In this manner, a new limit line can be easily generated based upon an existing limit line which has been shifted vertically and stored (*SAVE LIMIT LINE* softkey) under a new name (*NAME* softkey).

IEC/IEEE-bus command: CALC:LIM3:CONT:UPP:SHIF 20dB
CALC:LIM3:CONT:LOW:SHIF 20dB

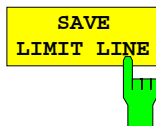

The *SAVE LIMIT LINE* softkey stores the currently edited limit line . The name can be entered in an input window (max. 8 characters)

IEC/IEEE-bus command: --

Display Lines

Display lines help to evaluate a trace – as do markers. The function of a display line is comparable to that of a ruler that can be shifted on the trace in order to mark absolute values.

The R&S ESCI provides two different types of display lines :

- two horizontal level lines for marking levels – Display Line 1/2,
- two vertical frequency or time lines for marking frequencies or points in time – Frequency/Time Line 1/2.

Each line is identified by one of the following abbreviations:

D1	Display Line 1
D2	Display Line 2
F1	Frequency Line 1
F2	Frequency Line 2
T1	Time Line 1
T2	Time Line 2

The level lines are continuous horizontal lines across the entire width of a diagram and can be shifted in y direction.

The frequency or time lines are continuous vertical lines across the entire height of the diagram and can be shifted in x direction.

The *DISPLAY LINES* submenu for activating and setting the display lines appears different depending on the display mode set in the active measurement window (frequency or time domain).

If the spectrum is shown (span \neq 0) the *TIME LINE 1* and *TIME LINE 2* softkeys are disabled, whereas in the time domain (span = 0) the *FREQUENCY LINE 1* and *FREQUENCY LINE 2* softkeys are not available.

Note: *The softkeys for setting and switching the display lines on/off work like triple switches:*

Initial situation: The line is off (softkey with gray background)

1st press: The line is switched on (softkey with red background) and the data input function is activated. The position of the display line can be selected by means of the rollkey, the step keys or a numerical entry in the appropriate field. The data input function is disabled if another function is activated. The line, however, remains switched on (softkey with green background).

2nd press: The line is switched off (softkey with gray background).

Initial situation: The line is on (softkey with green background)

1st press: The data input function is activated (softkey with red background). The position of the display line can be selected by means of the rollkey, the step keys or a numerical entry in the appropriate field. The data input function is disabled if another function is activated. The line, however, remains switched on (softkey with green background).

2nd press: The line is switched off (softkey with gray background).

LINES menu

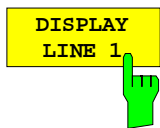
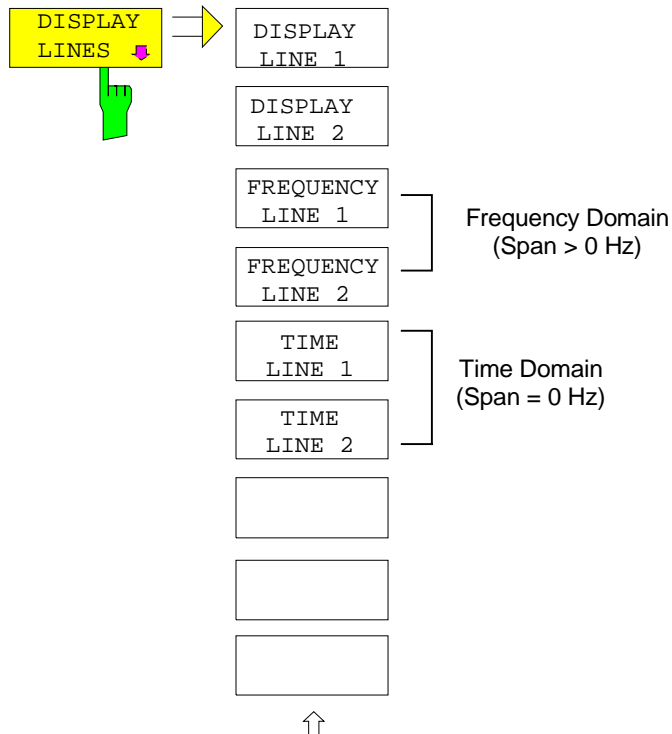

The *DISPLAY LINE 1/2* softkeys enable or disable the level lines and allow the user to enter the position of the lines.

The level lines mark the selected level in the measurement window.

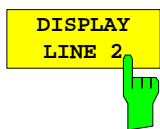

IEC/IEEE-bus command: `CALC:DLIN:STAT ON`
`CALC:DLIN -20dBm`

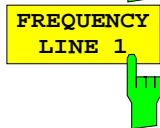

The *FREQUENCY LINE 1/2* softkeys enable or disable the frequency lines 1/2 and allow the user to enter the position of the lines.

The frequency lines mark the selected frequencies in the measurement window.

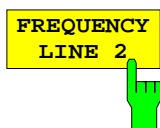

Note: *The two softkeys cannot be used in the time domain (span = 0).*

IEC/IEEE-bus command: `CALC:FLIN:STAT ON`
`CALC:FLIN 120MHz`

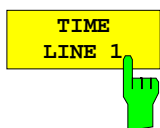

The *TIME LINE 1/2* softkeys enable or disable the time lines 1/ and allow the user to enter the position of the lines.

The time lines mark the selected times or define search ranges (see section "Marker Functions").

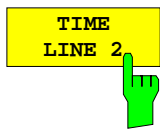

Note: *The two softkeys cannot be used in the frequency domain (span > 0).*

IEC/IEEE-bus command: `CALC:TLIN:STAT ON`
`CALC:TLIN 10ms`

Configuration of Screen Display – DISP Key

The *DISPLAY* menu allows the configuration of the diagram display on the screen and also the selection of the display elements and colors. The *POWER SAVE* mode is also configured in this menu for the display.

The test results are displayed on the screen of the R&S ESCI either in a full-screen window or in two overlapping windows. The two windows are called diagram A and diagram B.

In the default setting, the two windows are completely decoupled from each other, i.e. they behave like two separate instruments. This is very useful, for example with harmonics measurements or measurements on frequency-converting DUTs, since the input signal and the output signal lie in different frequency ranges.

However, specific settings of the two windows (reference level, center frequency) can be coupled, if required, so that with *CENTER B = MARKER A* for example, the shift of the marker in diagram A causes the frequency range (zoomed in some cases) to be shifted along diagram B.

In the default setting, the upper half of the screen shows the bar graph measurement of the receiver (screen A) and the lower half shows the sweep of the spectrum analyzer (screen B). Various instrument settings such as RF attenuation are coupled together for the two measurement screens, i.e. changing a setting in one of the measurement screens automatically changes it in the other screen. You can define which instrument settings are to be coupled from the *PARAM COUPLING* menu.

New settings are performed in the diagram selected via hotkey *SCREEN A* or *SCREEN B*. If only one window is displayed, it is the diagram in which the measurements are performed; the diagram not displayed is not active for measurements.

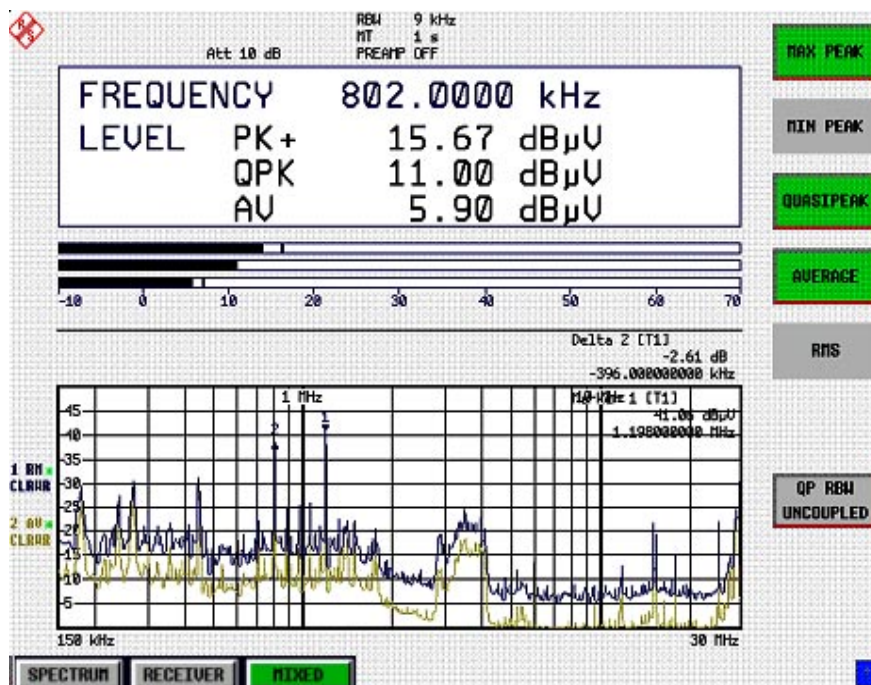
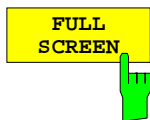
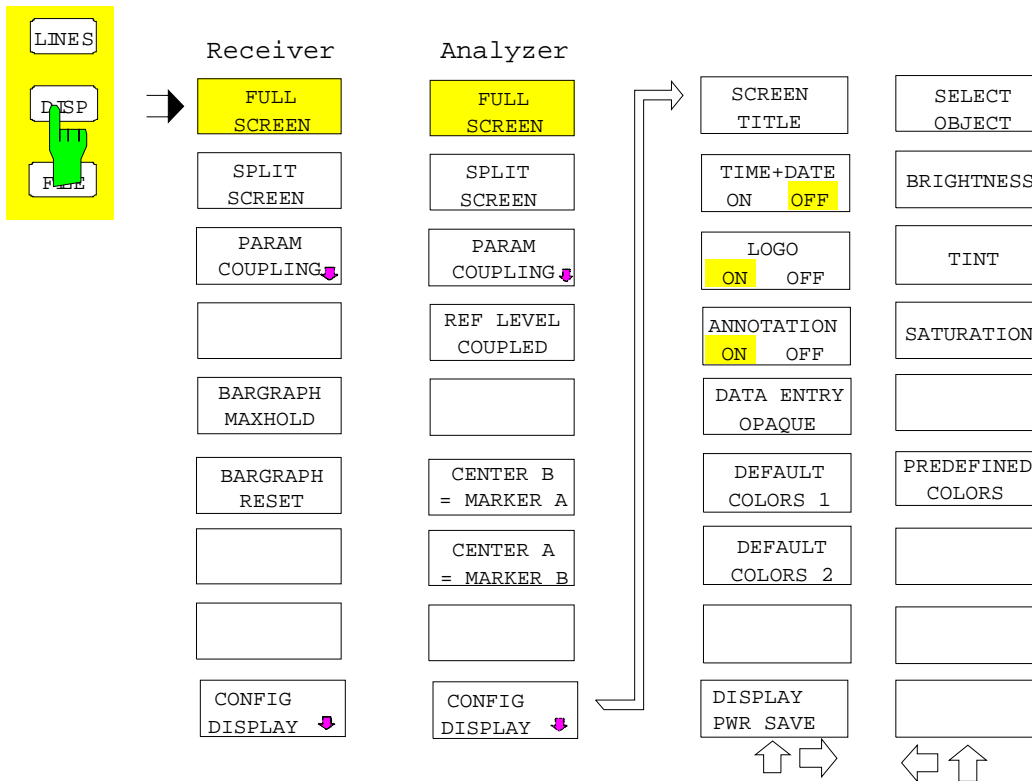

Fig. 4-21 Typical split-screen display, settings are uncoupled

The *DISP* key opens the menu for configuring the screen display and selecting the active diagram in SPLIT SCREEN mode.



The *FULL SCREEN* softkey selects the display of one diagram. This corresponds to the default setting of R&S ESCI.

In Analyzer mode it is possible to switch between two different device settings by selecting the active window (screen A or screen B). Switching between *SCREEN A* and *SCREEN B* is performed by means of the corresponding key in the *HOTKEY bar*:

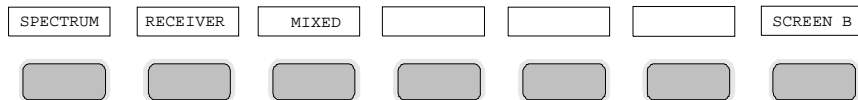

It should be noted that the measurements in the *FULL SCREEN* mode are performed only in the visible (active) window.

The active window is marked by **A** or **B** on the right of the diagram.

In Receiver mode, the full screen always displays the scan.

IEC/IEEE-bus command: `DISP:FORM SING`
`DISP:WIND<1 | 2>:SEL`

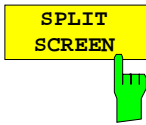

The *SPLIT SCREEN* softkey selects the display of two diagrams. The upper diagram is designated *SCREEN A*, the lower diagram *SCREEN B*.

Switching between *SCREEN A* and *SCREEN B* is performed via the corresponding key in the *HOTKEY* bar. The active window is marked by highlighting fields **A** and **B** on the right of the diagram.

In Receiver mode, screen A displays the receiver bargraph and screen B the scan diagram.

In Mixed mode, two screen combinations are available:

Level and frequency display (screen A) and analyzer spectrum (screen B)

or
Analyzer spectrum (screen B) and scan spectrum (screen B)

IEC/IEEE-bus command: DISP:FORM SPL

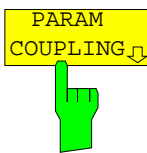

The *PARAM COUPLING* softkey opens the submenu for selecting the coupled parameters of receiver and analyzer mode.

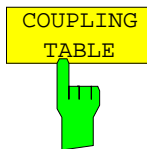
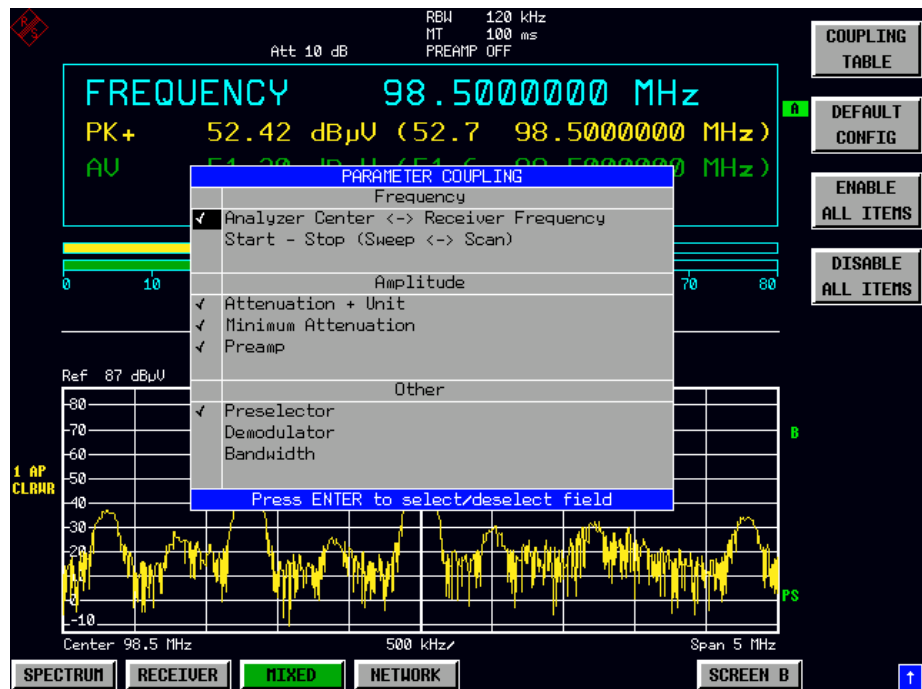

The *COUPLING TABLE* softkey opens the *PARAMETER COUPLING* table.

IEC/IEEE-bus commands: --

Analyzer Center	INST:COUP:CENT ALL
Start-Stop	INST:COUP:SPAN ALL
Attenuation, Unit	INST:COUP:ATT ALL
Minimum Attenuation	INST:COUP:PROT ALL
Preamp	INST:COUP:GAIN ALL
Preselector	INST:COUP:PRES ALL
Demodulator	INST:COUP:DEM ALL
Bandwidth	INST:COUP:BWID ALL

DEFAULT
CONFIG



The *DEFAULT CONFIG* softkey activates the preset settings of the *PARAMETER COUPLING* table.

IEC/IEEE-bus command: --

ENABLE
ALL ITEMS



The *ENABLE ALL ITEMS* softkey switches all of the possible couplings to on. The coupling of center frequency is switched on, therefore coupling of start /stop frequency is switched off.

IEC/IEEE-bus command: --

DISABLE
ALL ITEMS



The *DISABLE ALL ITEMS* softkey switches all of the possible couplings to off.

IEC/IEEE-bus command: --

BARGRAPH
MAXHOLD



The *BARGRAPH MAXHOLD* switches on the maxhold display of a single measurement..

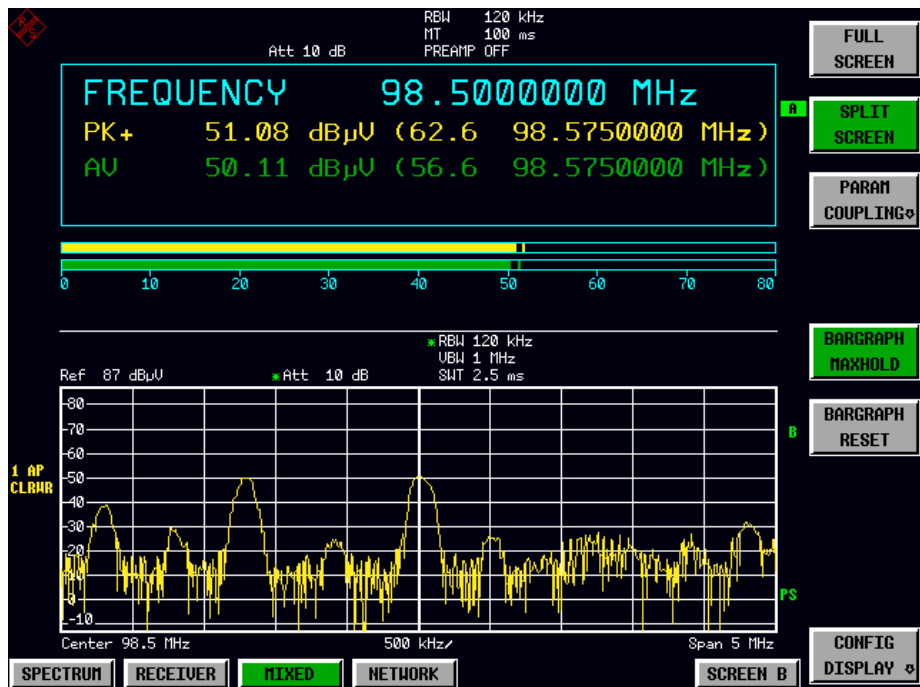

The BARGRAPH MAXHOLD softkey changes the display of the results of the bar graph measurement such that both the highest level for each detector and the frequency at which it is measured are displayed. The MAX Hold value will not be automatically reset by the instrument until BARGRAPH MAXHOLD is switched off or until, for example, the test receiver mode is deactivated as a result of switching to the spectrum analyzer.

Thus, you can also trace fluctuating interference signals in the frequency, and the highest measured value will remain on screen together with the associated frequency.

IEC/IEEE-bus command `DISP:BARG:PHOL ON`

BARGRAPH
RESET



The *BARGRAPH RESET* softkey resets the stored maximum values of the bargraph measurement.

IEC/IEEE-bus command `DISP:BARG:PHOL:RES`

REF LEVEL
COUPLED



The *REF LEVEL COUPLED* softkey switches the coupling of the reference level on and off. In addition to the reference level, the mixer level and input attenuation are coupled with one another.

For the level measurement, the same reference level and input attenuation must be set for the two diagrams.

IEC/IEEE-bus command `INST:COUP RLEV`

CENTER B
=MARKER A



CENTER A
=MARKER B



The *CENTER B = MARKER A* and *CENTER A = MARKER B* softkeys couple the center frequency in diagram B with the frequency of marker 1 in diagram A and the center frequency in diagram B with the frequency of marker 1 in diagram B. The two softkeys are mutually exclusive.

This coupling is useful, eg for viewing the signal at the marker position in diagram A with higher frequency resolution or in the time domain in diagram B.

If marker 1 is off, it is switched on and set to the maximum of the trace in the active diagram.

The softkeys are only available in receiver mode.

IEC/IEEE-bus command: `INST:COUP CF_B`
 `INST:COUP CF_A`

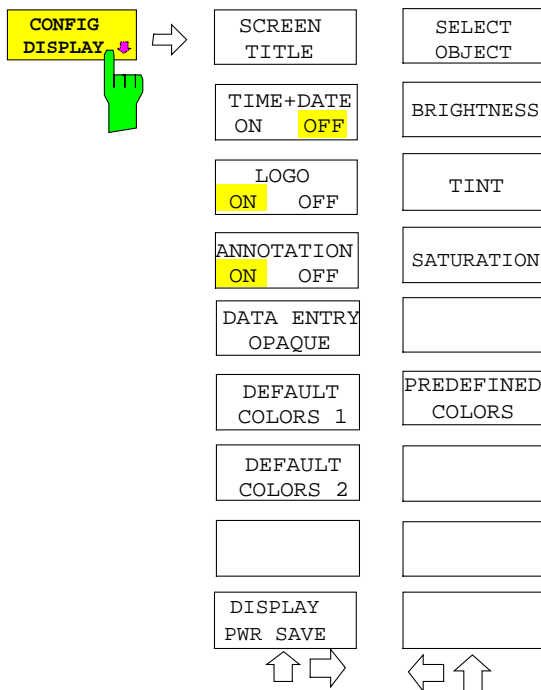

The CONFIG DISPLAY softkey opens a submenu allowing additional display items to be added to the screen. In addition, the display power-save mode (*DISPLAY PWR SAVE*) and the colors of the display elements can be set here.

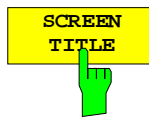

The *SCREEN TITLE* softkey activates the entry of a title for the active diagram A or B. It switches on or off a title that is already input. The length of the title is limited to max. 20 characters.

```
IEC/IEEE-bus command:  DISP:WIND1:TEXT 'Noise Meas'
                        DISP:WIND1:TEXT:STATE ON
```

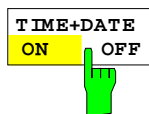

The *TIME+DATE ON/OFF* softkey switches on or off the display of date and time above the diagram.

```
IEC/IEEE-bus command:  DISP:TIME OFF
```



The *LOGO ON/OFF* softkey switches the Rohde & Schwarz company logo displayed in the upper left corner of the display screen on or off.

```
IEC/IEEE-bus command:  DISP:LOGO ON
```

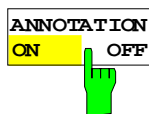

The *ANNOTATION ON/OFF* softkey switches the displaying of frequency information on the screen on and off.

ON Frequency information is displayed.
 OFF Frequency information is not outputted to the display. This can be used for example to protect confidential data.

```
IEC/IEEE-bus command:  DISP:ANN:FREQ ON
```

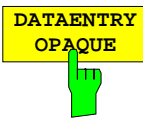

The *DATAENTRY OPAQUE* softkey sets the data entry windows to opaque. This means that entry windows are underlayed with the background color for tables.

IEC/IEEE-bus command: --



The *DEFAULT COLORS 1 and 2* softkey restores the default settings for brightness, color tint and color saturation for all display screen elements.

The color schemes have been selected to give optimum visibility of all picture elements at an angle of vision from above or below. *DEFAULT COLORS 1* is active in the default setting of the instrument.



IEC/IEEE-bus command: DISP:CMAP:DEF1
 DISP:CMAP:DEF2



The *DISPLAY PWR SAVE* softkey is used to switch on/off the power-save mode for the display and to enter the time for the power-save function to respond. After the elapse of this time the display is completely switched off, ie including backlighting.

Note: *This mode is recommended for saving the TFT display especially when the instrument is exclusively operated in remote control.*

The power-save mode is configured as follows:

- The first keystroke activates the power-save mode and opens the editor for the response time (*POWER SAVE TIMEOUT*). The response time is entered in minutes between 1 and 6 minutes and is confirmed by *ENTER*.
- The power-save mode is deactivated by pressing the key again.

On leaving the menu with the power-save mode in the activated state, the softkey is highlighted in color on returning to the menu and opens again the editor for the response time. Pressing again the key switches off the power-save mode.

IEC/IEEE-bus command: DISP:PSAV ON
 DISP:PSAV:HOLD 15

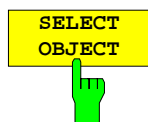

The *SELECT OBJECT* softkey activates the *SELECT DISPLAY OBJECT* table, with which a graphics element can be selected. After selection, the brightness, tint and saturation of the selected element can be changed using the softkeys of the same name. The color changes by means of the *PREDEFINED COLORS* softkey can be seen immediately on the display screen.



The *BRIGHTNESS* softkey activates entry of the brightness of the selected graphics element.

Values between 0 and 100% can be entered.

IEC/IEEE-bus: DISP:CMAP3:HSL < hue> , <sat> , <lum>

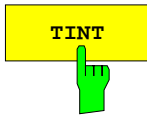

The *TINT* softkey activates the entry of the color tint of the selected element. The entered value is related to a continuous color spectrum ranging from red (0%) to blue (100%).

IEC/IEEE-bus: DISP:CMAP3:HSL <hue> , <sat> , <lum>



The *SATURATION* softkey activates the entry of the color saturation for the selected element.

The range of inputs is from 0 to 100%.

IEC/IEEE-bus: DISP:CMAP3:HSL <hue> , <sat> , <lum>



The *PREDEFINED COLORS* softkey activates a table, with which the predefined colors for the display screen elements can be selected.

IEC/IEEE-bus command: DISP:CMAP1 to 26:PDEF <color>

Instrument Setup and Interface Configuration – **SETUP** Key

The **SETUP** key opens the menu for configuration of the R&S ESCI:

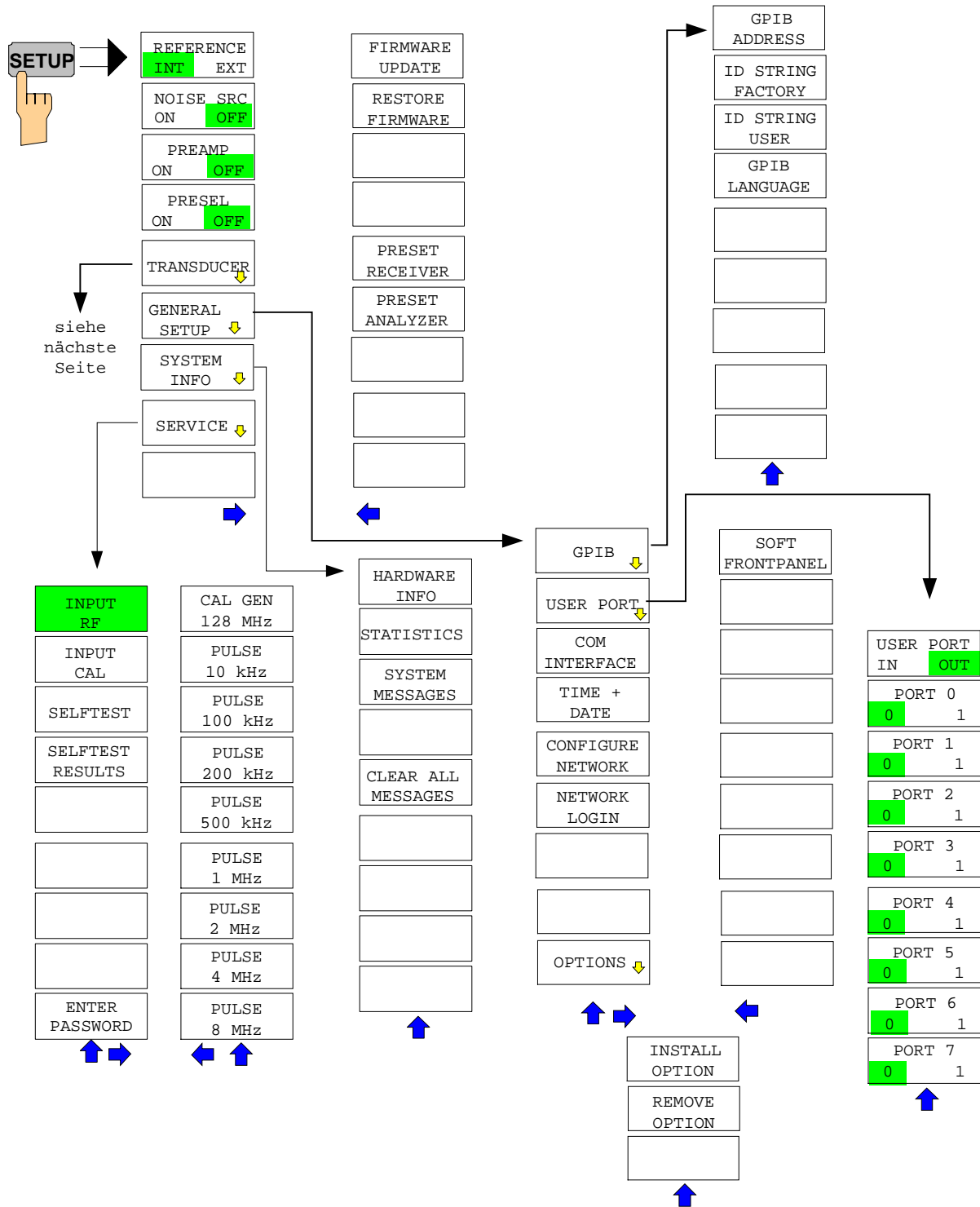

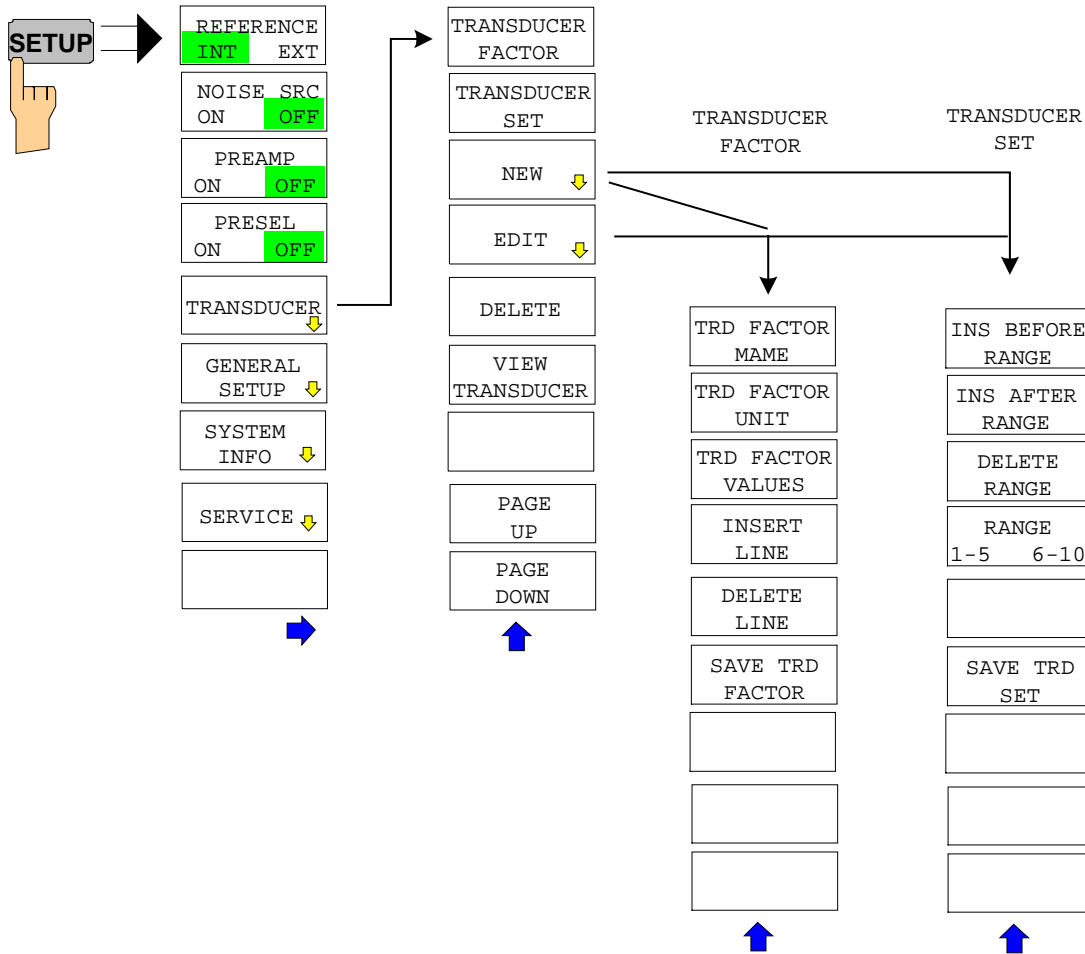

The following settings can be modified here:

- The *REFERENCE INT/EXT* softkey determines the source of the reference
- The *NOISE SRC ON/OFF* softkey switches on and off the voltage supply for an external noise source.
- The *PREAMP* softkey switches on the RF preamplifier gain..
- The *PRESELECT ON/OFF* softkey is used to switch the preselection.
- The *TRANSDUCER* softkey opens a submenu for editing and creating transducer factors and sets.
- The *GENERAL SETUP* softkey opens a submenu for all the general settings such as IEC/IEEE-bus address, date and time as well as the configuration of the device interfaces.
- The *SYSTEM INFO* softkey opens a submenu for displaying the hardware configuration of the instrument, the switching cycle statistics and system messages.
- The *SERVICE* softkey opens a submenu in which special device functions and system information can be selected for servicing. The password required for service functions can be entered in this submenu.
- The *SERVICE FUNCTIONS* softkey enables additional special settings for servicing and troubleshooting. It is available after entering the corresponding password under the *SERVICE* softkey.

External Reference Oscillator

The R&S ESCI can use the internal reference source or an external reference source as frequency standard from which all internal oscillators are derived. A 10 MHz crystal oscillator is used as internal reference source. In the default setting (internal reference), this frequency is available as output signal at rear-panel connector REF OUT, eg to synchronize other instruments to the reference of the R&S ESCI.

In the setting *REFERENCE EXT*, the connector REF IN is used as input connector for an external frequency standard. In this case all internal oscillators of the R&S ESCI are synchronized to the external reference frequency (also 10 MHz).

SETUP menu:

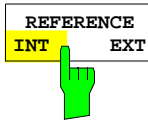

The *REFERENCE INT / EXT* softkey switches between the internal and external reference.

Note: *If the reference signal is missing when switching to external reference, the message "EXREF" appears after a while to indicate that there is no synchronization.*

On switching to internal reference please ensure that the external reference signal is de-activated to avoid interactions with the internal reference signal.

IEC/IEEE-bus command: ROSC:SOUR INT

External Noise Source

SETUP menu:

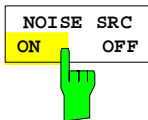

The *NOISE SRC ON/OFF* softkey switches on or off the supply voltage for an external noise source which is connected to the *NOISE SOURCE* connector on the rear panel of the instrument.

IEC/IEEE-bus command: DIAG:SERV:NSO ON

Preamplification and Preselection

In the frequency range up to 3 GHz, R&S ESCI offers a preselection with switchable preamplifier which can be selected by the user in the analyzer mode. The preselection is always active in the receiver mode.

The 20 dB preamplifier is available only if the preselection is switched on.

Preselection

The frequency range 9 kHz to 3 GHz is distributed over eleven filter bands.

Two fixed-tuned filters are used up to 2 MHz, eight tracking passband and high-pass filters from 2 MHz to 2000 MHz and a fixed-tuned high-pass filter above 2 GHz.

The filters are switched by a relay at 150 kHz and by PIN-diode switches above 150 kHz.

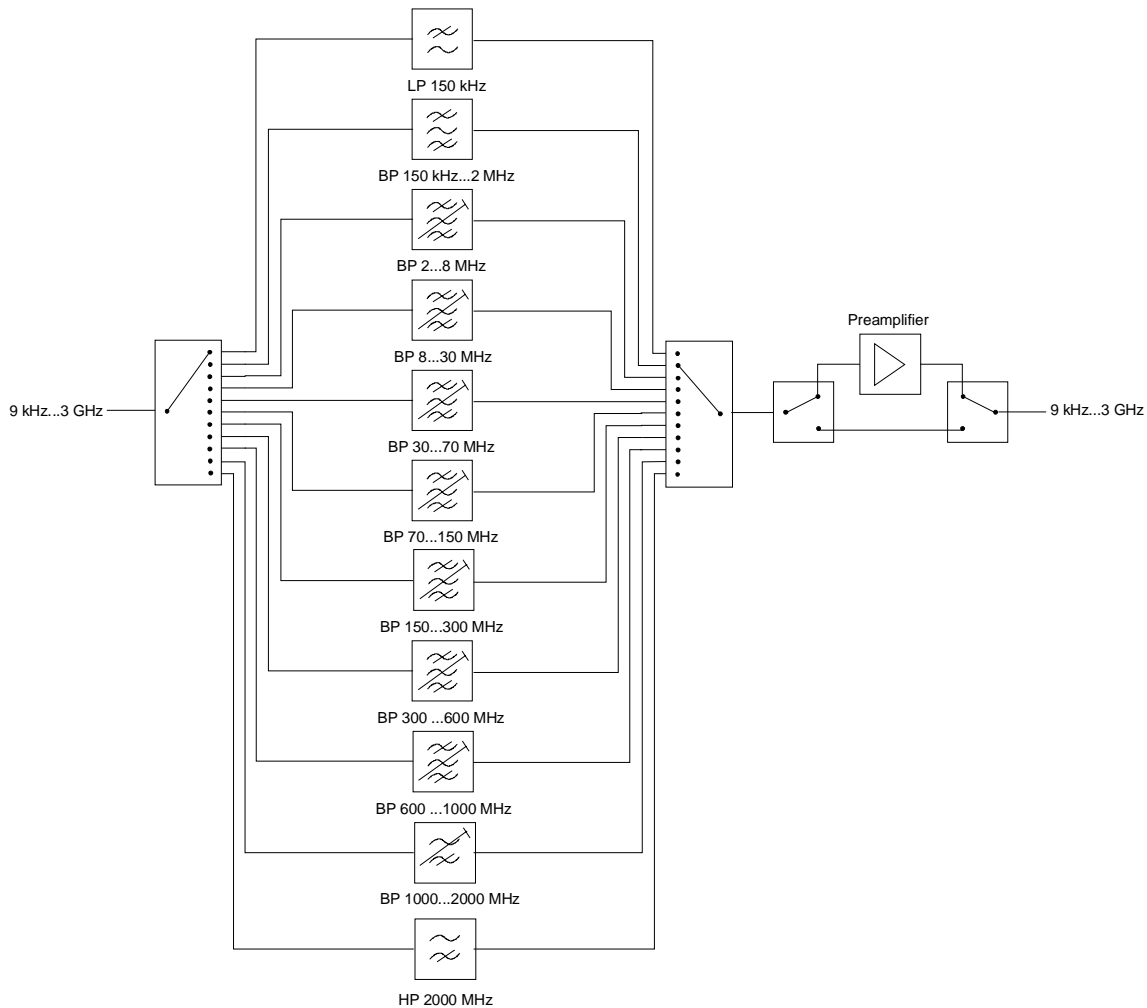

Fig. 4-21 Preselection and preamplifier

SETUP menu:



The *PRESELECT ON/OFF* softkey switches the preselection on or off.

The softkey is available only in the analyzer mode.

IEC/IEEE bus command INP: PRES ON

Preselection causes additional dependencies which are automatically taken into account in the coupled setting.

- With the preselection active, the FFT bandwidths are not available.
- With the preselection active, the start frequency is set to 150 kHz in the FULL SPAN setting to avoid permanent switching of the relay at the band limit of 150 kHz.
- Due to the limited tuning speed of the tracking passband filters, the maximum sweep rate (3 GHz / 5 ms) can no longer be attained with the preselection switched on. The minimum settable sweep time is obtained from the sum of the minimum possible sweep times in the associated filter bands.

Filter band	Min. sweep time for filter band
9 kHz to 150 kHz	-
150 kHz to 2 MHz	-
2 to 8 MHz	500 ms
8 to 30 MHz	50 ms
30 to 70 MHz	50 ms
70 to 150 MHz	50 ms
150 to 300 MHz	50 ms
300 to 600 MHz	50 ms
600 to 1000 MHz	50 ms
1000 to 2000 MHz	50 ms
2000 to 3000 MHz	-

Preamplification

Switching on the preamplifier diminishes the total noise figure of the R&S ESCI, thus increasing the sensitivity. The preamplifier follows the preselection filters so that the risk of overdriving by strong out-of-band signals is reduced to a minimum. The signal level of the subsequent mixer is 20 dB higher so that the maximum input level is reduced by the gain of the preamplifier. The total noise figure of R&S ESCI is reduced from approx. 18 dB to approx. 11 dB with the preamplifier switched on. The use of the preamplifier is recommended when measurements with a maximum sensitivity are to be performed. If the measurement should be performed at maximum dynamic range, the preamplifier should be switched off.

The gain of the preamplifier is automatically considered in the level display. In Analyzer mode, on switching on the preamplifier the RF attenuation or the reference level is adapted depending on the settings of the R&S ESCI.

SETUP menu:

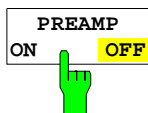

The *PREAMP ON/OFF* softkey switches the preamplifier on or off.

The softkey is available only in the analyzer mode when the measurement with preselection is activated.

IEC/IEEE bus command : INP> : GAIN : STAT OFF

Using Transducers

A transducer is often connected ahead of R&S ESCI both during the measurement of useful signals and EMI and converts the useful or interference variable such as field strength, current or RFI voltage into a voltage across 50 Ohm.

Transducers such as antennas, probes or current probes mostly have a frequency-dependent transducer factor which can be stored in R&S ESCI and automatically has the correct unit during level measurement.

If a transducer is switched on it is considered as part of the unit during the measurement, ie the measured values are displayed in the correct unit and magnitude. When working with two measurement windows, the transducer is always assigned to two windows.

R&S ESCI distinguishes between **transducer factor** and **transducer set**. A transducer factor takes the frequency response of a single transfer element, eg an antenna into consideration. A transducer set can summarize different transducer factors in several subranges (several transducer factors at the same time), eg an antenna, a cable and a diplexer.

A transducer factor consists of max. 50 reference values defined with frequency, transducer factor and the unit. For the measurement between frequency values linear or logarithmic interpolation of the transducer factor can be chosen.

Several factors can be compiled in a transducer set provided that all factors have the same unit or unit "dB". The frequency range covered by a set can be subdivided into max. 10 subranges (each with up to 4 transducer factors) which follow each other without a gap, ie the stop frequency of a subrange is the start frequency of the next subrange.

The transducer factors used in a subrange have to fully cover the subrange.

The definition of a transducer set is recommended if different transducers are used in the frequency range to be measured or if a cable attenuation or an amplifier has to be taken into consideration.

If a transducer set is defined during a frequency sweep, the latter can be stopped at the interface between two transducer ranges and the user is asked to exchange the transducer.

The following message informs the user that the limit has been reached:

TDS Range # reached, CONTINUE / BREAK

He can continue the sweep by confirming the message (*CONTINUE*) or he can switch off the transducer (*BREAK*).

With the automatic switchover of the transducer used, the frequency sweep is not interrupted.

Activating Transducer Factors and Transducer Sets

The *TRANSDUCER* softkey opens a submenu in which already defined transducer factors or sets can be activated or deactivated, new transducer factors or sets can be generated or existing transducer factors or sets can be edited. Tables with the defined transducer factors and sets are displayed. The table (factor or set) in which a transducer is active is set.

By switching on the transducers all the level settings and outputs are automatically made in the unit of the transducer. A change of the unit in menu *AMPT* is no longer possible as R&S ESCI together with the transducer used is regarded as a measuring instrument. Only if the transducer has the unit dB, can the original unit at R&S ESCI be maintained and changed.

If a transducer factor is active, "TDF" is displayed in the column of the enhancement labels and "TDS" if the transducer set is active.

After switching off all the transducers, R&S ESCI continues to use the unit which was selected before a transducer was switched on.

In the analyzer mode, an active transducer for a sweep is uniquely calculated for each point displayed after its setting and added to the result of the level measurement during the sweep. If the sweep range is changed, the correction values are recalculated. If several measured values are combined, only a single value is taken into consideration.

In the receiver mode, the transducer is also calculated for a set scan. The transducer is uniquely calculated for each frequency point and added to the result of the level measurement as the measurement results are stored internally and can be zoomed subsequently.

If an active transducer factor/set is not defined over the whole sweep or scan range during the measurement, the missing values are replaced by zero.

SETUP menu:

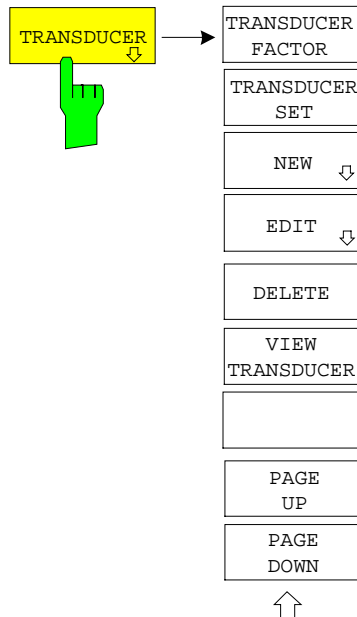

The *TRANSDUCER* softkey opens a submenu for editing existing transducer factor and sets or creating new transducer factor and sets.

Tables show the settings of already existing factors and sets as well as the settings of the active factor and set.

ACTIVE TRANSDUCER FACTOR			
Name:	Cable_1	Freq range:	10 MHz
Unit:	dB	to:	1 GHz
Comment:			

TRANSDUCER FACTOR	
Name	Unit
<input checked="" type="checkbox"/> Cable_1	dB
HK116	dBuV/m
HL223	dBuV/m

TRANSDUCER SET	
Name	Unit
30M-1G	dBuV/m

The upper table *ACTIVE TRANSDUCER FACTOR / SET* indicates the active transducer factor or the set with the associated name, frequency range and unit. If no factor or set is active, *NONE* is displayed in the table. Additional information can be entered in a comment line. If a transducer factor is active, the selected interpolation is displayed in addition, if a set is active, the break setting is displayed.

The left table *TRANSDUCER FACTOR* comprises all the defined factors with name and unit. If the number of defined transducer factors exceeds the number of possible lines in the table, the table will be scrolled.

The right table *TRANSDUCER SET* comprises all the defined transducer sets with the corresponding information.

Only one set or transducer can be activated. An already active transducer factor or set is switched off automatically if another one is switched on. An activated transducer factor or set is marked with a check sign.

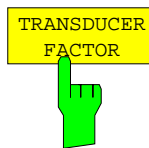

The *TRANSDUCER FACTOR* softkey sets the selection bar to the position of the active transducer factor. If no transducer factor is switched on, the bar is positioned to the first line of the table.

IEC/IEEE bus commands `CORR:TRAN:SEL <name>`
 `CORR:TRAN ON | OFF`

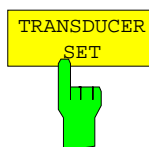

The *TRANSDUCER SET* softkey sets the selection bar to the position of the active transducer set. If no transducer set is switched on, the bar is set to the first line of the table.

IEC/IEEE bus commands `CORR:TSET:SEL <name>`
 `CORR:TSET ON | OFF`

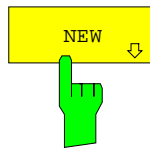

The *NEW* and *EDIT* softkeys both open the submenu for editing and creating transducer factors and sets.

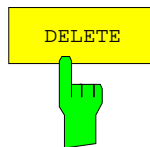
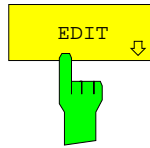

The *DELETE FACTOR/SET* softkey deletes the marked factor or set. To avoid deletion by mistake, deletion has to be confirmed.

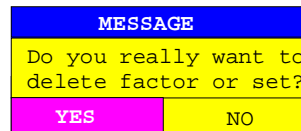

IEC/IEEE-bus command

CORR:TRAN DEL
CORR:TSET:DEL

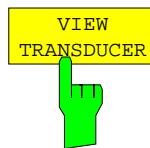

The *VIEW TRANSDUCER* softkey activates the display of the active transducer factor or set.

IEC/IEEE-bus command --

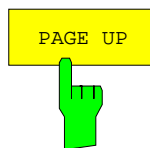

The *PAGE UP* and *PAGE DOWN* softkeys are used to scroll in large tables which cannot fully be displayed on the screen.

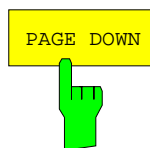

New Entry and Editing of Transducer Factors

A transducer factor is characterized by

- reference values with frequency and transducer factor (*Values*)
- the unit of the transducer factor (*Unit*) and
- the name (*Name*) to distinguish between the different factors.

During the entry, R&S ESCI checks the transducer factor according to specific rules that have to be met to ensure trouble-free operation.

- The frequencies for the reference values always have to be entered in ascending order. Otherwise, the entry is not accepted and the following message is displayed:

Frequency Sequence!

- The entered frequencies do not necessarily have to be set at R&S ESCI, as only the values for the frequency display range are considered for a set sweep or scan. The minimum frequency for a reference value is 0 Hz, the maximum frequency 200 GHz.

- The minimum or maximum value for a transducer factor is -200 dB or 200 dB. The unit "dB" means that the transducer factor is always logarithmic and has nothing to do with the physical transducer factor, which, for example, establishes the relationship between field strength and voltage into 50 Ohm. If the minimum or maximum value is exceeded, R&S ESCI signals:

Min Level -200 dB or

Max Level 200 dB.

- Amplifiers have a negative transducer factor, attenuation values have to be entered as a positive transducer factor.

Note: *The softkeys for the unit in the menu under key AMPT are inoperative with the transducer switched on.*

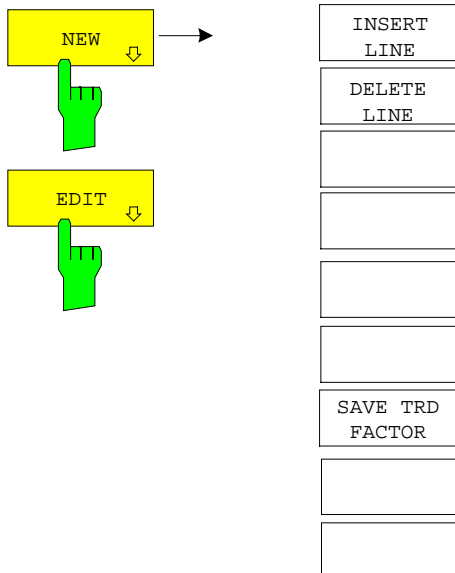

The *NEW* and *EDIT* softkeys both open the submenu for editing and entering new transducer factors if softkey *TRANSDUCER FACTOR* is active.

EDIT TRANSDUCER FACTOR			
Name/Unit/Interpolation:	Cable	dB	LIN
Comment :			
FREQUENCY	TDF/dB..	FREQUENCY	TDF/dB..
1.0000000 MHz	1.000		
1.0000000 GHz	5.500		

The table with the data of the marked factor (the *EDIT* softkey) or an empty table is displayed in which the following entries are preset (the *NEW* softkey):

Unit: dB
 Interpolation: LIN for linear frequency scaling
 LOG for logarithmic frequency scaling

The characteristics of the factor can be entered in the header field of the table, the frequency and the transducer factor in the columns of the table.

Name Entry of the name
Unit Selection of unit
Interpolation Selection of interpolation
Comment Entry of a comment
FREQUENCY Entry of the frequency of the reference points
TDF/dB Entry of the transducer factor.

An overwritten transducer factor remains stored in the background as long as the edited factor is stored with the *SAVE TRD FACTOR* softkey or until the table is closed. A factor overwritten by mistake can be restored by leaving the entry.

Name - Entry of name

A maximum of 8 characters is permissible for the name. The characters have to comply with the convention of DOS file names. The unit automatically stores all transducer factors with the extension .TDF.

If an existing name is changed, the factor stored under the previous name is retained and will not be overwritten automatically with the new name. The previous factor can be deleted at a later time, using *DELETE*. Thus, factors can be copied.

IEC/IEEE-bus command CORR:TRAN:SEL <name>

Unit – Selection of unit

The unit of the transducer factor is selected from a selection box activated by the ENTER key.

FACTOR UNIT
dB
dBm
dB μ V
dB μ V/m
dB μ A
dB μ A/m
✓ dBpW
dBpT

The default setting is dB.

IEC/IEEE-bus command CORR:TRAN:UNIT <string>

Interpolation - Selection of interpolation

Linear or logarithmic interpolation can be carried out between the frequency reference points of the table. Selection is via the ENTER key which is toggled between LIN and LOG (toggle function).

IEC/IEEE-bus command CORR:TRAN:SCAL LIN|LOG

The following diagrams indicate the effect of the interpolation on the calculated characteristic:

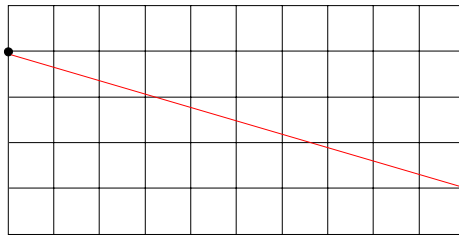

Fig. 4-22 Linear frequency axis and linear interpolation

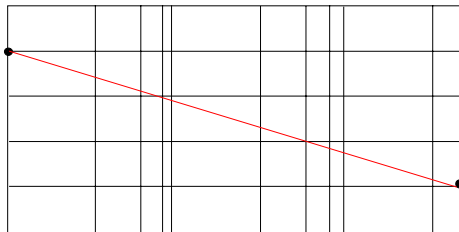

Fig. 4-23 Logarithmic frequency axis and logarithmic interpolation

Comment - Entry of a comment

The comment can be freely selected. It can have a maximum number of 50 characters.

IEC/IEEE-bus command CORR:TRAN:COMM <string>

FREQUENCY, TDF/dB – Input of reference values

The selection bar marks the first reference value. The desired reference values have to be entered in ascending frequency sequence.

After entering the frequency the selection bar automatically jumps to the corresponding level value.

After entering the first reference value the table can be edited. The two *INSERT LINE* and *DELETE LINE* softkeys are displayed. Individual values are changed at a later time by marking the field and by entering the new value.

IEC/IEEE-bus command `CORR:TRAN:DATA <freq>,<level>,...`

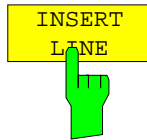

The *INSERT LINE* softkey inserts a free line above the marked reference value. When entering a new reference value into this line watch out for the ascending frequency sequence.

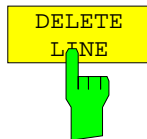

The *DELETE LINE* softkey deletes the marked reference value (the whole line). The following reference values move up.

IEC/IEEE-bus command `--`



The *SAVE TRD FACTOR* softkey saves the changed table in a file on the internal hard disk.

If a transducer factor with the same name already exists, a corresponding query is performed beforehand.

If the factor to be newly saved is currently switched on, the new values will immediately be valid. If a transducer set is switched on comprising the factor, the values will only be used when the set is switched on next time.

IEC/IEEE-bus command `-` (executed automatically after definition of reference values)

New Entry and Editing of Transducer Sets

A transducer set is characterized by:

- maximum 10 ranges (*Ranges*) in which different transducer factors can be active
- the combination of several transducer factors per range (*Factor*)
- a transducer-set name (*Name*)

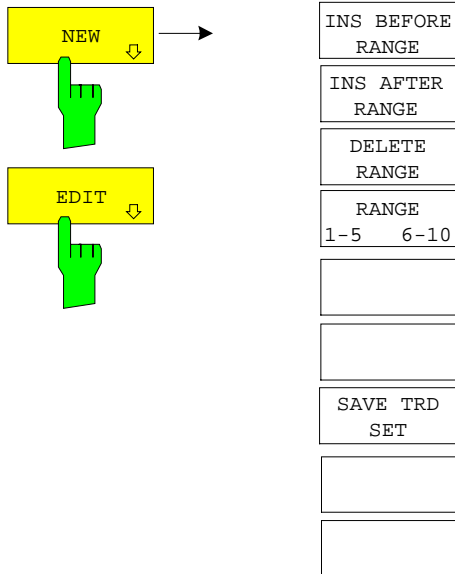

The *NEW* and *EDIT* softkeys both open the submenu for editing and entering new transducer factors if softkey *TRANSDUCER SET*.

EDIT TRANSDUCER SET					
Name/Unit/Break				dBuV	OFF
Comment :					
	RANGE1	RANGE2	RANGE3	RANGE4	RANGE5
Start	30 MHz	300 MHz			
Stop	300 MHz	1 GHz			
Factors	Cable Antenna1	Cable Preamp Antenna2			

The table with the data of the marked set (the *EDIT* softkey) or an empty table in which the following entries are preset (the *NEW* softkey) is displayed:

Unit: dB
Break: OFF

The characteristics of the set can be entered in the header field of the table, the subranges in the columns of the set.

- Name* Entry of the name
- Unit* Selection of unit
- Break* Activating the query when changing the subrange
- Comment* Entry of a comment
- Start* Entry of the start frequency of the subrange
- Stop* Entry of the stop frequency of the subrange
- Factors* Selection of the transducer factors for the subrange

An overwritten transducer set remains stored in the background as long as the edited factor is stored with the *SAVE TRD SET* softkey or until the table is closed. A set overwritten by mistake can be restored by leaving the entry.

Name - Entry of name

A maximum of 8 characters is permissible for the name. The characters have to comply with the convention of DOS file names. The unit automatically stores all transducer sets with the extension .TDS.

If an existing name is changed, the set stored under the previous name is retained and will not be overwritten automatically with the new name. The previous set can be deleted at a later time using *DELETE FACTOR/SET*. Thus, sets can be copied.

IEC/IEEE-bus command `CORR:TSET:SEL <name>`

Unit - Selection of unit

The unit of the transducer set is selected from a selection box activated by the ENTER key.

The unit should be selected prior to the entry as it determines the settable transducer factors. The preset unit for new sets is "dB".

SET UNIT	
	dB
	dBm
	dB μ V
	dB μ V/m
	dB μ A
	dB μ A/m
✓	dBpW
	dBpT

IEC/IEEE-bus command `CORR:TSET:UNIT <string>`

Break - Activation of query when changing a subrange

The sweep can be stopped if the user changes the subrange and selects a new subrange of the transducer. A message informs the user that the limit has been attained. He can continue the sweep or switch off the transducer. The interruption is activated by setting Break to ON. Selection is by the ENTER key which toggles between ON and OFF (toggle function).

IEC/IEEE-bus command `CORR:TSET:BRE ON|OFF`

Start - Entry of start frequency of subrange

Stop - Entry of stop frequency of subrange

The individual subranges have to be linked without a gap. That is why the start frequency is already defined from the second subrange (= stop frequency of previous range).

IEC/IEEE-bus command `CORR:TSET:RANG<1.10>`
`<freq>, <freq>, <name>..`

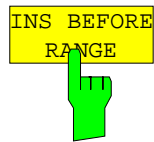

The *INS BEFORE RANGE* softkey copies the active column and inserts it to the right. The frequency limits can be edited.

IEC/IEEE-bus command --

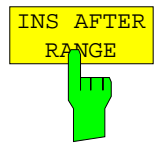

The *INS AFTER RANGE* softkey copies the active column and inserts it to the left. The frequency limits can be edited.

IEC/IEEE-bus command --

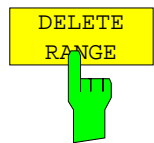

The *DELETE RANGE* softkey deletes the marked subrange. The following subranges move left.

IEC/IEEE-bus command --

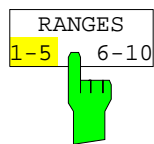

The *RANGES 1-5/6-10* softkey switches between the display of ranges 1 to five and ranges 6 to 10.

IEC/IEEE-bus command --

Factors - Selection of factors for the subrange

The permissible transducer factors for the marked subrange can be selected in a selection box. Only factors matching with the unit of the set and fully covering the selected subrange are permissible.

SELECT
V<NONE>
Cable
Antennal

After each change of range limits, R&S ESCI thus checks the factor list and, if required, rebuilds it.

After reducing the start frequency or increasing the stop frequency of a range it may happen that the factors defined for this range no longer fully cover the range. These factors are deleted for this range when the transducer factor table is opened next time.

A maximum of 4 transducer factors can be switched on at the same time in each subrange. If none of them is switched on, 0 dB is assumed as a factor for the whole subrange.

IEC/IEEE-bus command --

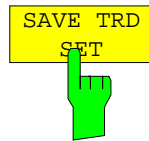

The *SAVE TRD SET* softkey saves the changed table in a file on the internal hard disk. If a transducer name with the same name already exists, a corresponding query is performed beforehand:

If the saved set is switched on, the new values will be used immediately.

IEC/IEEE-bus command -- (executed automatically)

Programming the Interface Configuration and Time Setup

The *GENERAL SETUP* softkey opens a sub-menu in which the general instrument parameters can be set up. In addition to the configuration of the digital interfaces (*IECBUS*, *COM*), the date and time may be entered.

The current settings are displayed in tabular form on the display screen where they may be edited.

SETUP submenu:

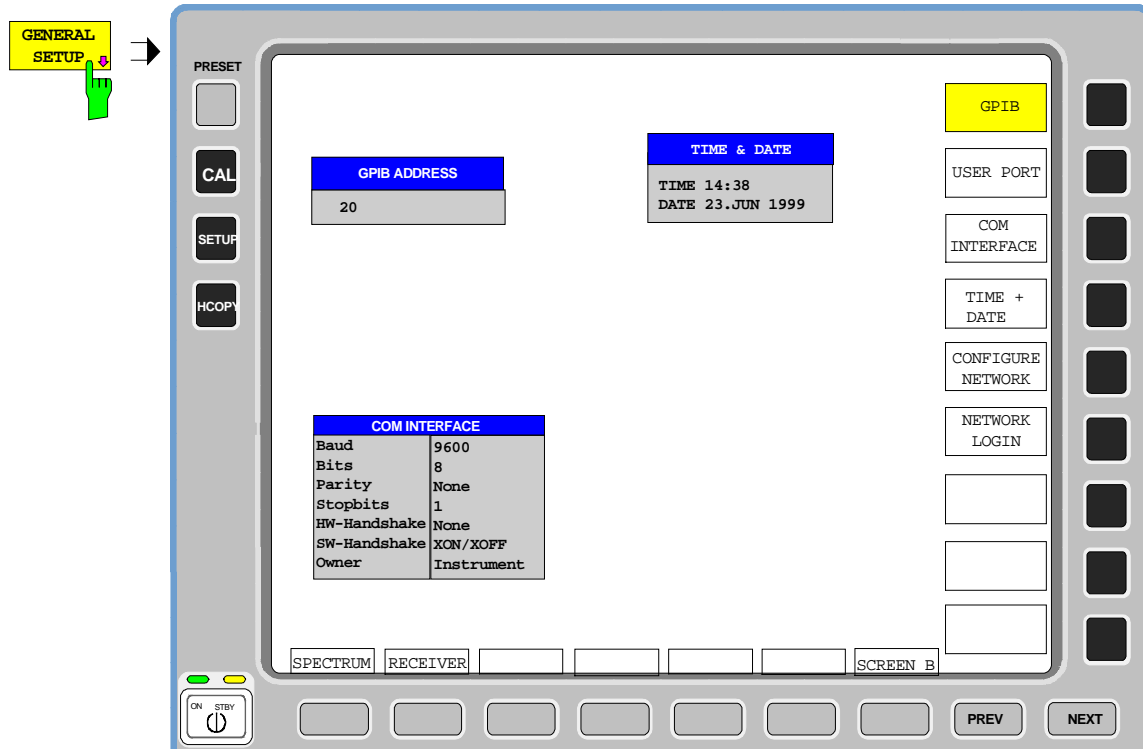

Selecting the IEC/IEEE-bus address

SETUP - GENERAL SETUP menu:

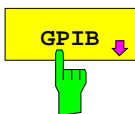

The *GPIB* softkey opens a submenu for setting the parameters of the remote-control interface.

IEC/IEEE-bus command: --

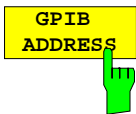

The *GPIB ADDRESS* softkey enables the entry of the IEC/IEEE-bus address. Valid addresses are 0 through 30. The default address is 20.

IEC/IEEE-bus command: SYST:COMM:GPIB:ADDR 20



The *ID STRING FACTORY* softkey selects the default response to the *IDN? query.

IEC/IEEE-bus command: --

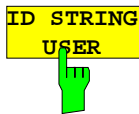

The *ID STRING USER* softkey opens an editor for entering a user-defined response to the *IDN? query.

Max. length of output string: 36 characters

IEC/IEEE-bus command: --



The *GPIB LANGUAGE* softkey opens a list of selectable remote-control languages:

- SCPI, 8560E, 8561E, 8562E, 8563E, 8564E, 8565E, 8566A, 8566B, 8568A, 8568B, 8594E

Note:

For 8566A/B, 8568A/B and 8594E, command sets A and B are available. Command sets A and B differ in the rules regarding the command structure.

On switching between remote-control languages, the following settings or changes will be made:

SCPI:

- The instrument will perform a *PRESET*.

8566A/B, 8568A/B, 8594E:

- The instrument will perform a *PRESET*.
- The following instrument settings will then be changed:

Model	# of Trace Points	Start Freq.	Stop Freq.	Ref Level	Input Coupling
8566A/B	1001	2 GHz	22 GHz	0 dBm	DC (ESCI) AC (ESPI)
8568A/B	1001	0 Hz	1.5 GHz	0 dBm	AC
8560E	601	0 Hz	2.9 GHz	0 dBm	AC
8561E	601	0 Hz	6.5 GHz	0 dBm	AC
8562E	601	0 Hz	13.2 GHz	0 dBm	AC
8563E	601	0 Hz	26.5 GHz	0 dBm	AC
8564E	601	0 Hz	40 GHz	0 dBm	AC
8565E	601	0 Hz	50 GHz	0 dBm	AC
8594E	401	0 Hz	3 GHz	0 dBm	AC

IEC/IEEE-bus command: SYST:LANG "SCPI" | "8560E" | "8561E" |
 "8562E" | "8563E" | "8564E" |
 "8565E" | "8566A" | "8566B" |
 "8568A" | "8568B" | "8594E" |

User Port Configuration

The instrument provides a parallel interface, which is 8 bits wide. Over these ports, arbitrary bit patterns can be output or input.

CONFIGURATION SETUP-GENERAL SETUP submenu:

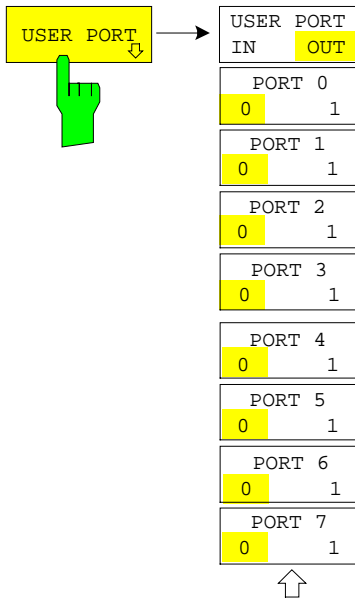

The *USER PORT* softkey opens the sub menu for setting the direction of the data transmission and for entering the values of the individual ports.

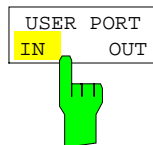

The *USER PORT IN/OUT* determines in which direction the interface transmits data.

USER PORT (read operation)

The value is indicated in a window. A new readout is started by pressing *READ*. Pressing *OK* closes the window

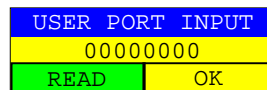

IEC/IEEE-bus command: INP:UPOR:STAT ON
INP:UPOR?

USER PORT OUT (write operation)

The bit pattern selected with softkeys *PORT 0* to *PORT 7* is output.

IEC/IEEE-bus command: OUTP:UPOR:STAT ON

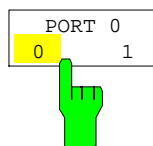

The *PORT 0 0/1* to *PORT 7 0/1* softkeys determine the output value for port 1 to 7. These softkeys are only available for setting *USER PORT OUT*.

IEC/IEEE-bus command: OUTP:UPOR STAT ON
OUTP:UPOR #B10110010

Serial Interface Configuration

SETUP-GENERAL SETUP submenu:



The *COM INTERFACE* softkey activates the *COM INTERFACE* table for entry of the serial interface parameters.

The following parameters can be configured in the table:

<i>Baud rate</i>	data transmission rate
<i>Bits</i>	number of data bits
<i>Parity</i>	bit parity check
<i>Stop bits</i>	number of stop bits
<i>HW-Handshake</i>	hardware handshake protocol
<i>SW-Handshake</i>	software handshake protocol
<i>Owner</i>	assignment to the measuring instrument or computer

COM INTERFACE	
Baud	9600
Bits	8
Parity	None
Stopbits	1
HW-Handshake	None
SW-Handshake	XON/XOFF
Owner	Instrument

Baud – Data transmission rate

The R&S ESCI supports baud rates between 110 and 19200 baud. The default setting is 9600 baud.

BAUD RATE
19200
✓ 9600
4800
1200
600
300
110

IEC/IEEE-bus command: SYST:COMM:SER:BAUD 9600

Bits – Number of data bits per word

For the transmission of text without special characters, 7 bits are adequate. For binary data as well as for text with special characters, 8 bits must be selected (default setting).

BITS
✓ 7
8

IEC/IEEE-bus command: SYST:COMM:SER:BITS 7

Parity – Bit parity check

- NONE no parity check (default setting)
- EVEN even parity check
- ODD odd parity check

PARITY	
	NONE
✓	EVEN
	ODD

IEC/IEEE-bus command: SYST:COMM:SER:PAR NONE

Stop bits – Number of stop bits

Available are 1 and 2. The default setting is 1 stop bit.

STOPBITS	
	1
✓	2

IEC/IEEE-bus command: SYST:COMM:SER:SBIT 1

HW-Handshake – Hardware handshake protocol

The integrity of data transmission can be improved by the use of a hardware handshake mechanism, which effectively prevents uncontrolled transmission of data and the resulting loss of data bytes. For hardware handshake additional interface lines are used to transmit acknowledge signals with which the data transmission can be controlled and, if necessary, stopped until the receiver is ready to receive data again.

A prerequisite for using hardware handshaking is, however, that the interface lines (DTR and RTS) are connected on both transmitter and receiver. For a simple 3-wire connection, this is not the case and hardware handshake cannot be used here.

Default setting is *NONE*.

HW - HANDSHAKE	
	None
✓	DTR/RTS

IEC/IEEE-bus command: SYST:COMM:SER:CONT:DTR OFF
 SYST:COMM:SER:CONT:RTS OFF

SW-Handshake – Software handshake protocol

Besides the hardware handshake mechanism using interface lines, it is also possible to achieve the same effect by using a software handshake protocol. Here, control bytes are transmitted in addition to the normal data bytes. These control bytes can be used, as necessary, to stop data transmission until the receiver is ready to receive data again.

In contrast to hardware handshaking, software handshaking can be realized even for a simple 3-wire connection.

One limitation is, however, that software handshaking cannot be used for the transmission of binary data, since the control characters XON and XOFF require bit combinations that are also used for binary data transmission.

Default setting is *NONE*.

SW-HANDSHAKE	
	None
<input checked="" type="checkbox"/>	XON/XOFF

IEC/IEEE-bus command: SYST:COMM:SER:PACE NONE

Owner – Assignment of the interface

The serial interface can be assigned alternatively to the measuring instrument section or to the computer section

If the interface is assigned to one section of the instrument, it is not available to the other section.

INSTRUMENT The interface is assigned to the measuring instrument section. Outputs to the interface from the computer section are not possible will get lost.

OS The interface is assigned to the computer section. It cannot be used by the measuring instrument section. This means that remote control of the instrument via the interface is not possible.

OWNER	
<input checked="" type="checkbox"/>	INSTRUMENT
	OS

IEC/IEEE-bus command: --

Setting Date and Time

SETUP-GENERAL SETUP submenu:

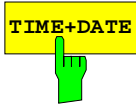

The *TIME+DATE* softkey activates the entry of time and date for the internal real time clock.

TIME AND DATE	
Time	21:59
Date	01 Oct 1997

Time - Input of time

In the corresponding dialog box, the time is partitioned into two input fields so that hours and minutes can be entered independently.

TIME		
TIME	21	: 59

IEC/IEEE-bus command: SYST:TIME 21,59

Date - Input of Date

In the corresponding dialog box, the date is partitioned into 3 input fields so that day, month and year can be input separately.

DATE			
DATE	01	Oct	1999

For the selection of the month, pressing a unit key opens a list of abbreviations wherein the desired month can be selected.

MONTH
JAN
FEB
MAR
APR
MAY
JUN
JUL
AUG
SEP
✓ OCT
NOV
DEC

IEC/IEEE-bus command: SYST:DATE 1999,10,01

Configuration of network settings (with option FSP-B16 only)

The instrument can be connected to an Ethernet LAN (local area network) by means of the LAN Interface Option FSP-B16. This allows data transmission via the network and the use of network printers. The network card is able to handle both 10 MHz Ethernet IEEE 802.3 and 100 MHz Ethernet IEEE 802.3u.

For more details see section 'LAN Interface - Option FSP-B16'.

SETUP - GENERAL SETUP - menu:

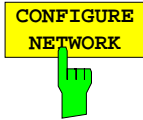

The *CONFIGURE NETWORK* softkey opens the dialog box with the network settings.

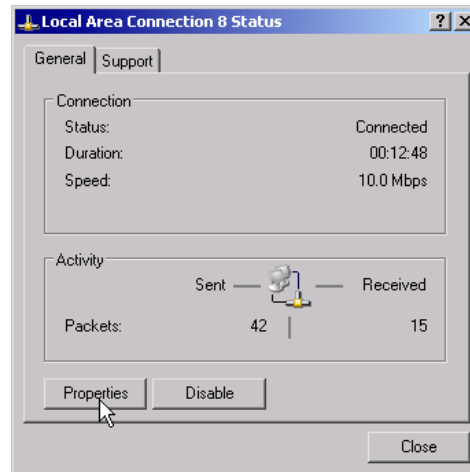

The softkey is used to modify an existing network configuration after the corresponding tabs are selected (see subsection "Configuration of Already Installed Network Protocols" in the section describing the LAN Interface FSP-B16).

- Notes:**
- A PC keyboard with trackball (or mouse instead) is required for the installation/configuration of the network support.
 - The softkey is only available with built-in LAN interface option (FSP-B16).

IEC/IEEE-bus command: -



The *NETWORK LOGIN* softkey opens the dialog box with the auto login settings.

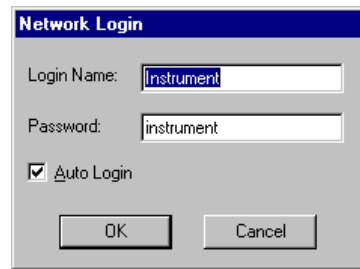

When a network is installed, the preset user name 'Instrument' and the password 'instrument' can be adapted to a new user (see section 'Defining Users' in the LAN interface manual).

With the 'Auto Login' option active, an automatic registration is performed during booting with the specified user name and password. Otherwise the Windows XP login request is displayed during booting.

- Notes:**
- A PC keyboard with trackball (or additional mouse instead) is required for the installation/configuration of the network support.
 - The softkey is only available with built-in LAN interface FSP-B16".

IEC/IEEE-bus command: -

Enabling Firmware Options

The *OPTIONS* softkey opens a submenu that allows license keys for firmware options to be entered. Previously installed options are displayed in a table that opens automatically.

IEC/IEEE-bus command: OPT?

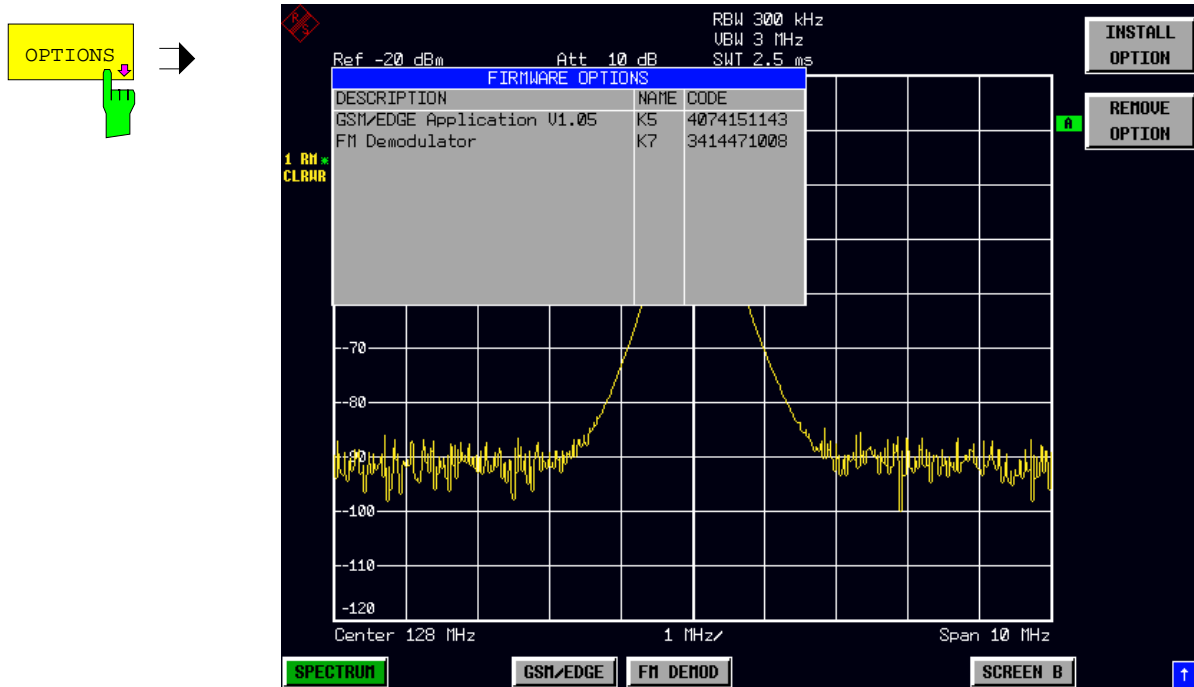

Softkey *INSTALL OPTION* opens the data entry for the license keycode of a firmware option.

On entry of a valid license key the message *OPTION KEY OK* is displayed in the status line and the firmware option appears in table *FIRMWARE OPTIONS*.

On entry of an invalid license key the message *OPTION KEY INVALID* is displayed in the status line.

IEC/IEEE-bus command: --



Softkey *REMOVE OPTION* removes all firmware options from the instruments. Execution of this function must be confirmed in a message box in order to avoid removal of the firmware options by mistake.

IEC/IEEE-bus command: --

Emulation of the instrument front panel

SETUP - GENERAL SETUP – NEXT menu:



The *SOFT FRONTPANEL* softkey switches the display of the front-panel keys on and off.

When the front-panel keys are displayed on the screen, the instrument can be controlled by clicking the respective button with the mouse. This is especially useful when the instrument in a different site is controlled via a remote-control program, such as, for instance, the remote desktop of Windows XP, and the screen contents are transferred to the controller via remote link (see the section "LAN Interface - Remote Desktop under Windows XP).

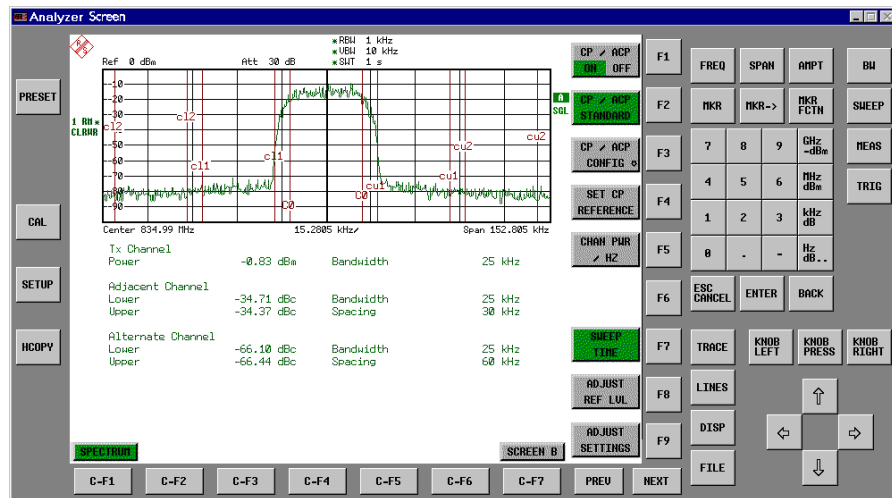

Note:

Display resolution:

When the display of the front-panel keys is switched on, the screen resolution of the instrument changes to 1024x768 pixels. Only a section of the total screen is then displayed on the LC display, which will automatically be shifted on mouse moves.

In order to obtain a complete display of the user interface, an external monitor is to be plugged into the corresponding connector at the rear panel. Prior to performing the resolution change the user is prompted for confirmation whether the required monitor is connected.

Switching off the front-panel display restores the original screen resolution.

Key assignment:

Button labels largely correspond to those of the front-panel keys. The rotation function of the rotary knob is assigned to the 'KNOB LEFT' and 'KNOB RIGHT' buttons, the press function (<ENTER>) to 'KNOB PRESS'.

The labels of the softkey buttons (F1 to F9) and of the hotkey buttons (C-F1 to C-F7) indicate that the keys can be operated directly by means of the corresponding function keys F1 to F9 or <CTRL>F1 to <CTRL>F7 of a PS/2 keyboard.

IEC/IEEE-bus command: SYST:DISP:FPAN ON

System Information

The *SYSTEM INFO* softkey opens a submenu in which detailed information on module data, device statistics and system messages is displayed.

SETUP menu:



Display of Module Data

SETUP SYSTEM INFO submenu:



The *HARDWARE INFO* softkey opens a table in which the modules (INSTALLED COMPONENTS) installed in the instrument are listed together with the corresponding hardware revisions.

Table *HARDWARE INFO* consists of six columns:

- SERIAL # serial number
- COMPONENT name of module
- ORDER # order number
- MODEL model number of the module
- REV main modification index of the module
- SUB REV secondary modification index of the module

HARDWARE INFO						
COMPONENT	SERIAL#	ORDER#	MODEL	HWC	REV	SUB REV
RF_ATTEN_7	688557/038	1067.7684	00	00	21	00
FRONTEND1	694276/035	1093.5540	03	01	07	11
FRONTEND2	684659/010	1093.5791	03	01	05	12
IF-FILTER/REF	689712/066	1093.7242	02	00	04	04
DETECTOR	662771/012	1093.6998	02	00	02	08
Preselct_EMI	101486/001	1093.7120	02	00	01	00
AF_DEMOD	740975/052	1093.7620	02	00	03	04
CPU-Board	000117/125	1091.2489	00	00	04	11
MOTHERBOARD	101485/001	1142.8171	03	00	01	00
ESCI	834014/005	1142.8007	03	00	00	00
LAN Interface	000000/000	1093.9080	00	00	00	00

Note: The screenshot lists the components of an R&S ESCI with option FSP-B16 (LAN interface).

Display of Device Statistics

SETUP SYSTEM INFO submenu:

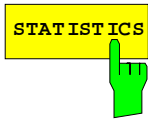

The *STATISTICS* softkey opens the table *STATISTICS*. This table contains the model information, serial number and firmware version, and a list in which the operating time of the instrument, the power-on cycles as well as attenuator switching cycles are displayed.

STATISTICS	
Model	ESCI
Serial #	123456/789
Firmware Rev	1.23
BIOS Rev	1.00
Operating time (hours)	375
Power On Cycles	786
Attenuator Cycles	57
Input RF/Cal	1786
10 dB	1473
20 dB	675
40 dB	

IEC/IEEE-bus command: --

Display of System Messages

SETUP SYSTEM INFO submenu:

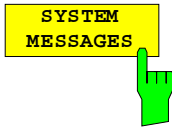

The *SYSTEM MESSAGES* softkey opens a submenu including a table in which the generated system messages are displayed in the order of their occurrence. The most recent messages are placed at the top of the list.

The following information is available:

No	Device specific error code
MESSAGE	Brief description of the message
COMPONENT	On hardware messages: name of the affected module
	On Software messages: if needed, the name of the affected software components
DATE/TIME	Date and time of the occurrence of the message

Messages that have occurred since the last call to the *SYSTEM MESSAGES* menu are marked with an asterisk '*'.

The *CLEAR ALL MESSAGES* softkey is activated and allows clearing of the error buffer.

If the number of error messages exceeds the capacity of the error buffer, the message appearing first is "Message buffer overflow".

SYSTEM INFO			
No	MESSAGE	COMPONENT	DATE/TIME
01	No of cycles	Attenuator	05.Jan.99 10:02:00
02	VCO unlock	Frontend	05.Jan.99 10:01:30
03	Calamp range	IF Filter	05.Jan.99 10:00:50
04	3.3V: Voltage	Detector	04.Jan.99 15:58:10
05	I2C-Bus failed	CPU	04.Jan.99 15:58:05

IEC/IEEE-bus command: SYST:ERR?



The *CLEAR ALL MESSAGES* softkey deletes all messages in the table. The softkey is only available when table *SYSTEM INFO* is active.

IEC/IEEE-bus command: SYST:ERR?

Service Menu

The service menu offers a variety of additional functions which are used for maintenance and/or trouble shooting.



Caution:

The service functions are not necessary for normal measurement operation. However, incorrect use can affect correct operation and/or data integrity of the R&S ESCI. Therefore, many of the functions can only be used after entering a password. They are described in the instrument service manual.

SETUP menu:

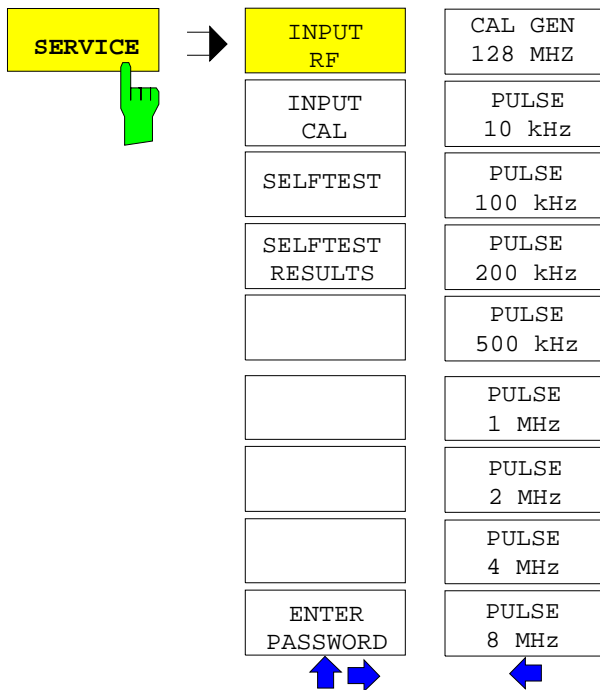

The *SERVICE* softkey opens a submenu for selection of the service function.

The *INPUT RF* and *INPUT CAL* softkeys are mutually exclusive selection switches. Only one switch can be active at any one time.

General Service Functions

SETUP SERVICE submenu:

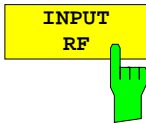

The *INPUT RF* softkey switches the input of the R&S ESCI to the input connector (normal position).

After *PRESET*, *RECALL* or R&S ESCI power on, the *INPUT RF* is always selected.

IEC/IEEE-bus command: DIAG:SERV:INP RF

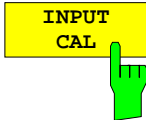

The *INPUT CAL* softkey switches the RF input of the R&S ESCI to the internal calibration source (128 MHz) and activates the data entry of the output level of the calibration source. Possible values are 0 dB and -30 dB.

IEC/IEEE-bus command: DIAG:SERV:INP CAL;

DIAG:SERV:INP:CSO 0 DBM



The *ENTER PASSWORD* softkey allows the entry of a password.

The R&S ESCI contains a variety of service functions which, if incorrectly used, can affect correct operation of the receiver. These functions are normally not accessible and are only usable after the entry of a password (see instrument service manual).

IEC/IEEE-bus command: SYST:PASS "Password"

SETUP SERVICE NEXT submenu:

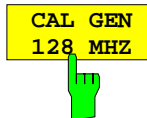

The *CAL GEN 128 MHZ* softkey selects a sinusoidal signal at 128 MHz as output signal for the internal calibration source. The internal pulse generator will be switched off.

CAL GEN 128 MHZ is the default setting of the R&S ESCI.

IEC/IEEE-bus command: DIAG:SERV:INP:PULS OFF

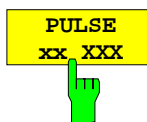

The *PULSE xx* softkey switches the selected pulse generator on.

IEC/IEEE-bus command: DIAG:SERV:INP CAL
DIAG:SERV:INP:PULS ON;
DIAG:SERV:INP:PRAT 2 MHZ

Selftest

SETUP SERVICE submenu:



The *SELFTEST* softkey initiates the selftest of the instrument modules.

With this function the instrument is capable of identifying a defective module in case of failure.

During the selftest a message box appears in which the current test and its result is shown. The test sequence can be aborted by pressing ENTER ABORT.

All modules are checked consecutively and the test result (selftest PASSED or FAILED) is output in the message box.

IEC/IEEE-bus command: *TST?



The *SELFTEST RESULTS* softkey calls the *SELFTEST* table in which the results of the module test are displayed.

In case of failure a short description of the failed test, the defective module, the associated value range and the corresponding test results are indicated.

SELFTEST			
SELFTEST: FAILED		24.APR.1999 14:25	
		Service level: 0	
TEST	RESULT	VALID RANGE	VALUE
Voltages	OK		
Pretune DAC	OK		
Synthesizer	FAIL		
Frontend2 128MHz Ref unlock	FAIL	1.25V...3.5V	1.14V
Frontend1 384MHz Ref Input	OK	0.5...0.6V	0V
Signal Path	OK		

IEC/IEEE-bus command: DIAG:SERV:STE:RES?

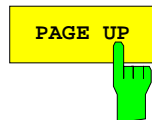

The *PAGE UP* or *PAGE DOWN* softkey sets the *SELFTEST RESULTS* table to the next or previous page.

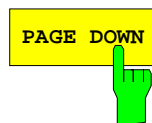

IEC/IEEE-bus command --

Hardware Adjustment

Some of the R&S ESCI modules can be re-aligned. This re-alignment can become necessary after calibration due to temperature drift or aging of components (see service manual instrument).



Caution:

The re-alignment should be carried out by qualified personnel since the changes considerably influence the measurement accuracy of the instrument. This is the reason why the softkeys **REF FREQUENCY**, **CAL SIGNAL POWER** and **SAVE CHANGES** can only be accessed after entering a password.

Firmware Update

The installation of a new firmware version can be performed using the built-in diskette drive. The firmware update kit contains several diskettes.

The installation program is called in the *SETUP* menu.

SETUP side menu:

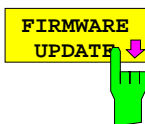

The *FIRMWARE UPDATE* softkey opens the subdirectory for installing/deinstalling new firmware versions.

IEC/IEEE-bus command: --

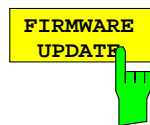

The *FIRMWARE UPDATE* softkey starts the installation program and leads the user through the remaining steps of the update

IEC/IEEE-bus command: --

The firmware update is started as follows:

Insert disk 1 into the floppy drive.

Call *SETUP* side menu via **[SETUP][NEXT]**

Start the update via **[FIRMWARE UPDATE]**

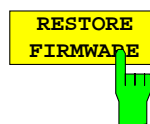

The *RESTORE FIRMWARE* softkey restores the previous firmware version

IEC/IEEE-bus command: --



The *UPDATE PATH* softkey is used to select the drive and directories under which the archive files for the firmware update are stored.

The firmware update can thus also be performed via network drives or USB memory sticks/USB-CD-ROM drives.

IEC/IEEE-bus command:

```
"SYST:FIRM:UPD 'D:\USER\FWUPDATE' "
```

Saving and Recalling Data Sets – FILE Key

Overview

The *FILE* key calls the following functions:

- Storage/loading functions for storing (*SAVE*) instrument settings such as instrument configurations (measurement/display settings, etc) and measurement results from working memory to permanent storage media, or to load (*RECALL*) stored data into working memory.
- Functions for management of storage media (*FILE MANAGER*). Included are among others functions for listing files, formatting storage media, copying, and deleting/rename files.

The R&S ESCI is capable of internally storing complete instrument settings with instrument configurations and measurement data in the form of data sets. The respective data are stored on the internal hard disk or, if selected, on a floppy. The hard-disk and floppy-disk drives have the following names:

floppy disk A:
 hard disk D: (hard disk C: is reserved for instrument software)

The configuration of the softkeys in the menu is shown in the following figure:

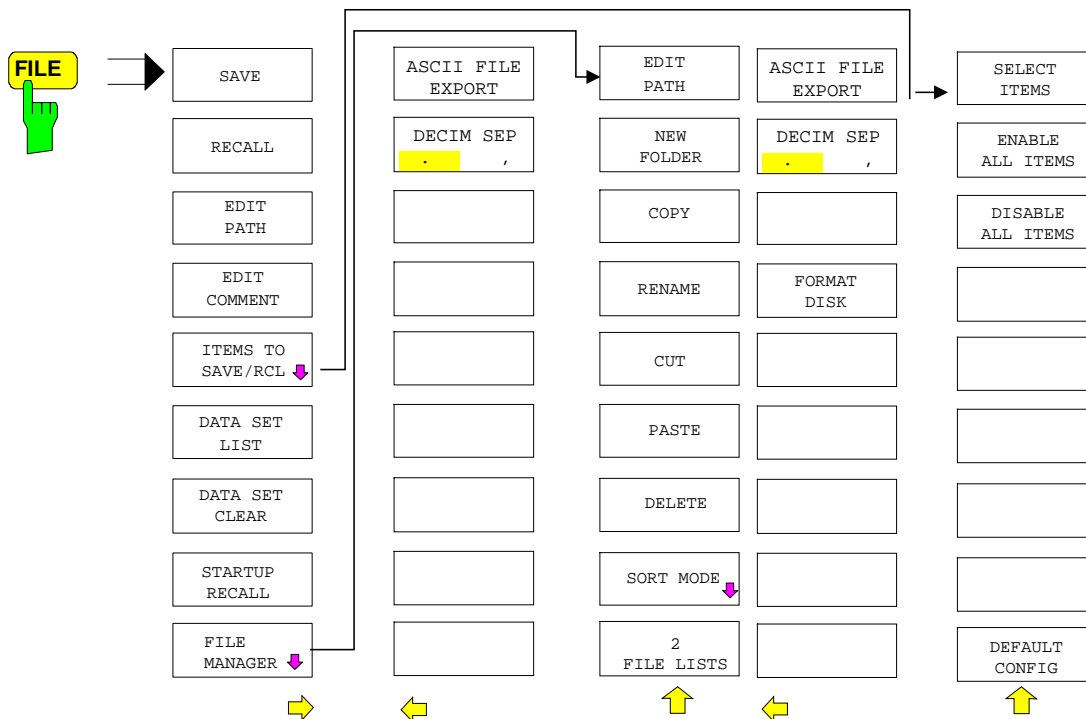

Storing a Device Configuration

Storing a Complete Device Configuration

The following steps are required to store a complete device configuration:

- Press the *FILE* key and then press the *SAVE* softkey.

The selection box for the device configuration will be opened:

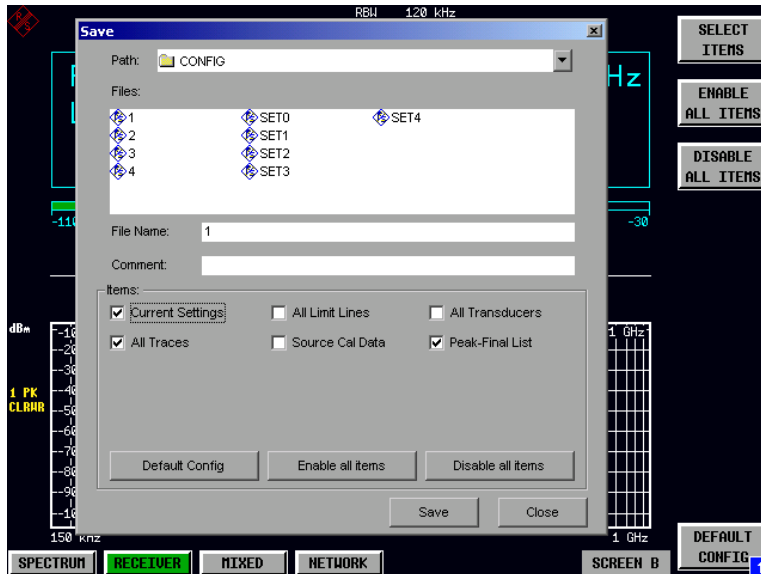

- Enter the name of the data set to be stored (in the simplest case, a digit from 0 to 9) and press *ENTER*. The data set will be stored and the dialog window closed. The name of the data set may comprise letters and digits; if required, the desired directory may precede the name of the data set (the directory will then automatically be used for further *SAVE* and *RECALL* processes). The help line editor, which can be opened by pressing the *Cursor Down*  key, is available for entering file names via the front-panel keypad. For further information on the operation of this editor, see section "Entering Text using the Help Line Editor".

How to enter comments, change the path for the file to be stored and select the data set from a list is described under the associated softkeys *EDIT COMMENT*, *EDIT PATH* and *DATA SET LIST*.

The default path for the device configuration is D:\USER\CONFIG. The file names of the data sets have the extension .ESCI.

Storing Parts of a Device Configuration

To store part of a data set (e.g. "All Transducers"), the partial data set has to be selected beforehand. The following steps are required:

- Press the *FILE* key and then the *SAVE* softkey.
- Press the *ITEMS TO SAVE/RCL* softkey. The entry focus moves to the first entry in the *Items* field.
- Use the spinwheel to move the entry focus to the desired entry in the *Items* field and select the partial data set by pressing the spinwheel or *ENTER*. The selection of already highlighted partial data sets can be cancelled by pressing the spinwheel / *ENTER* again.

Softkeys *ENABLE ALL ITEMS / DISABLE ALL ITEMS* are also available to select all partial data sets or to cancel the selection.

- Move the entry focus to the field *File Name* using the spinwheel and activate the text entry by pressing the spinwheel.
- Enter file names and store the data set with *ENTER*.

Loading a Data Set

A data set may be loaded in two different ways:

1. Direct entry of data set name:

- Press the *FILE* key and then press the *RECALL* softkey.
- Enter the name of the data set to be stored (in the simplest case, a digit from 0 to 9) and press *ENTER*. The data set will be loaded.

The name of the data set may comprise letters and digits; if required, the desired directory may precede the name of the data set (the directory will then automatically be used for further *SAVE* and *RECALL* processes).

The help line editor, which can be opened by pressing the *Cursor Down*  key, is available for entering file names via the front-panel keypad.

For further information on the operation of this editor, see section "Entering Text using the Help Line Editor".

2. Selection of data set via a selection list:

- Press the *FILE* key and then press the *RECALL* softkey.
 - Press the *ITEMS TO SAVE/RCL* softkey.
- The list of available data sets will be selected:

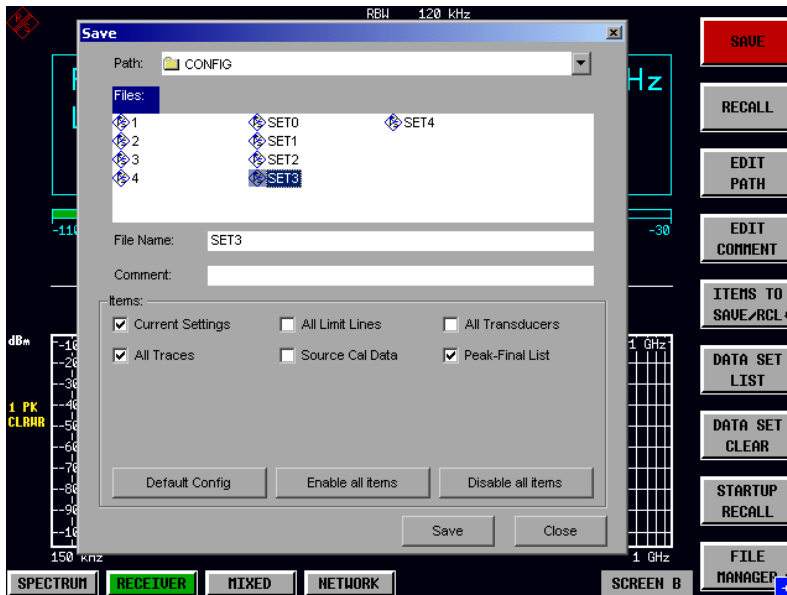

- Select the data set to be loaded with the spinwheel and confirm twice with *ENTER*. The data set will be loaded.

If the path for the device configuration is to be changed, this is done via the *EDIT PATH* softkey. When loading device data, the settings of the unloaded partial data sets will remain unchanged. The R&S ESCI recognizes which parts the loaded data set has and ignores selected but unavailable partial data sets.

Automatic Loading of a Data Set during Booting

When the R&S ESCI is delivered, it will load the device setting last activated when the unit was switched off (provided that the unit was switched off via the *STANDBY* switch at the front panel, see section 1 "Putting the Device Into Operation").

Moreover, the R&S ESCI is also able to automatically load a user-defined data set. The following operating steps are required:

- Press the **FILE** key and then press the **RECALL** softkey.
 - Press the **STARTUP RECALL** softkey.
- The list of available data sets will be selected:

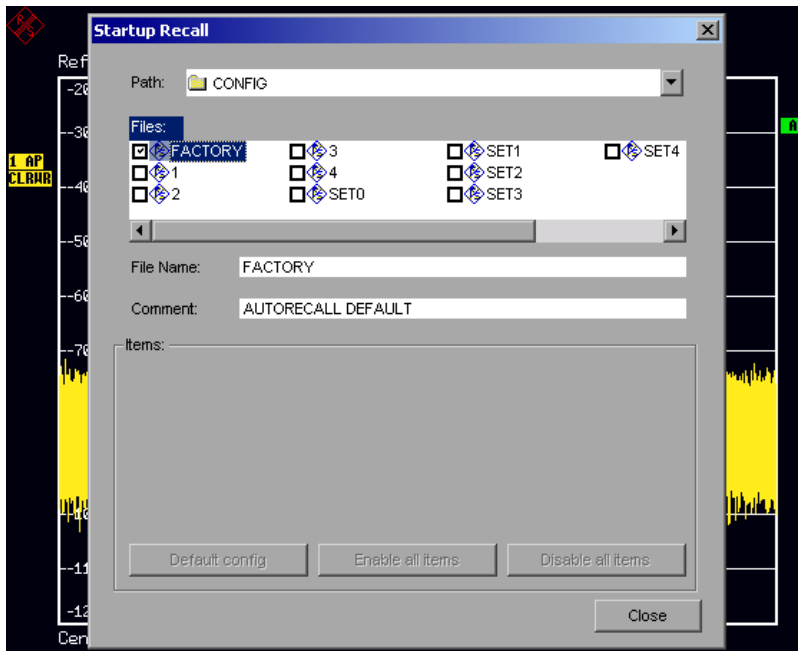

- Select the data set to be loaded using the spinwheel and mark with **ENTER**.

Notes:

1. The selected data set will also be loaded when pressing the **PRESET** key.
2. The entry **FACTORY** will load the last setting that was activated prior to switch-off when the unit is started after delivery.

- Close the dialog window by pressing **ESC** twice.

If the path is to be changed for the device configuration, this is done via the **EDIT PATH** softkey.

Copying Data Sets to Disk

The saved files of the data sets can be copied from one storage medium (e.g. drive D:) to another storage medium (e.g. drive A:) or to another directory using the functions found in the **FILE MANAGER** submenu. The file extension **.ESCI** must not be changed.

EnteringText with the Help Line Editor



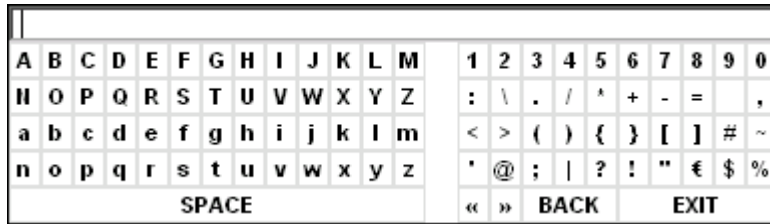

The help line editor is opened as soon as the *CURSOR DOWN*  key is pressed on a text entry field (*File Name, Comment*):



The entry range consists of two parts:

- editing line
- character selection field

Die *CURSOR DOWN*  key is used to move from the editing line to the character selection field.

The navigation in the character selection field is by means of the spinwheel or the cursor keys , ,  and .



The desired characters are transferred to the editing line by pressing the spinwheel or by pressing the *ENTER* key:



The fields of the last line of the character selection field have special functions:

- SPACE adds a space to the editing line
- << moves the cursor in the editing line by one character towards the left
- >> moves the cursor in the editing line by one character towards the right
- BACK deletes the character in front of the cursor
- EXIT stores the contents of the editing line and closes the help line editor

A return to the editing line is possible via the *CURSOR UP*  key (return from the top line of the character selection field).

Within the editing line, navigation is also performed by means of the spinwheel or the cursor keys  and .

Digits, decimal points and signs are directly entered into the editing line via the keys of the numeric block provided at the front panel. With a PC keyboard connected, letters and special characters can also be entered directly.

Editing is terminated via *ENTER* if the text is to be stored and via *ESC* if the text is to be discarded. The help line editor will be closed in both cases.

Description of the Individual Softkeys

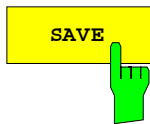

The **SAVE** softkey opens the dialog window for entering the data set to be stored.

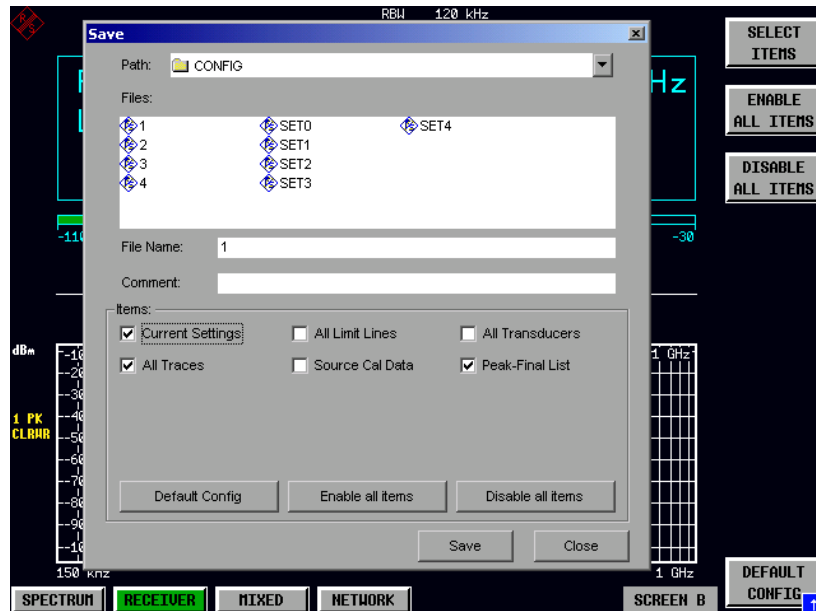

The **SAVE** table contains the entry fields for editing the data set:

<i>Path</i>	Directory in which the data set is stored.
<i>Files</i>	List of data sets already stored.
<i>File Name</i>	Name of data set. The name can be entered with or without drive name and directory; the drive name and directory, if available, will then appear in the PATH field. The extension of the data name is ignored.
<i>Comment</i>	Comment regarding the data set.
<i>Items</i>	Selection of settings to be stored.

IEC/IEEE command: `MMEM:STOR:STAT 1,"a:\test02"`

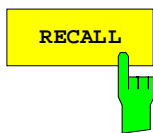

The *RECALL* softkey activates the dialog window to enter the data set to be loaded.

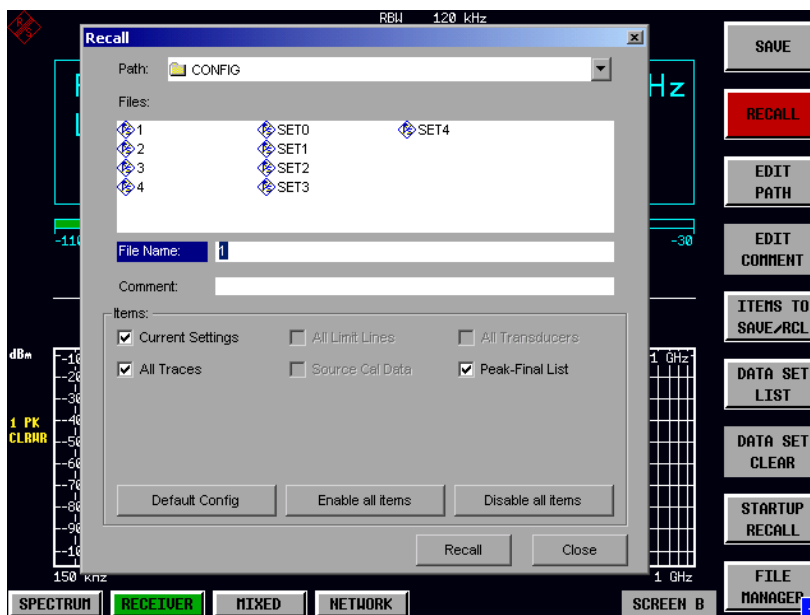

The *RECALL* table shows the current settings regarding the data set:

<i>Path</i>	Directory in which the data set is stored.
<i>Files</i>	List of stored data sets
<i>File Name</i>	Name of data set. The name can be entered with or without drive name and directory. The drive name and directory will then appear in the Path field. A potential extension of the file name is ignored.
<i>Comment</i>	Comment regarding data set.



IEC/IEEE command: `MMEM:LOAD:STAT 1,"a:\test02"`

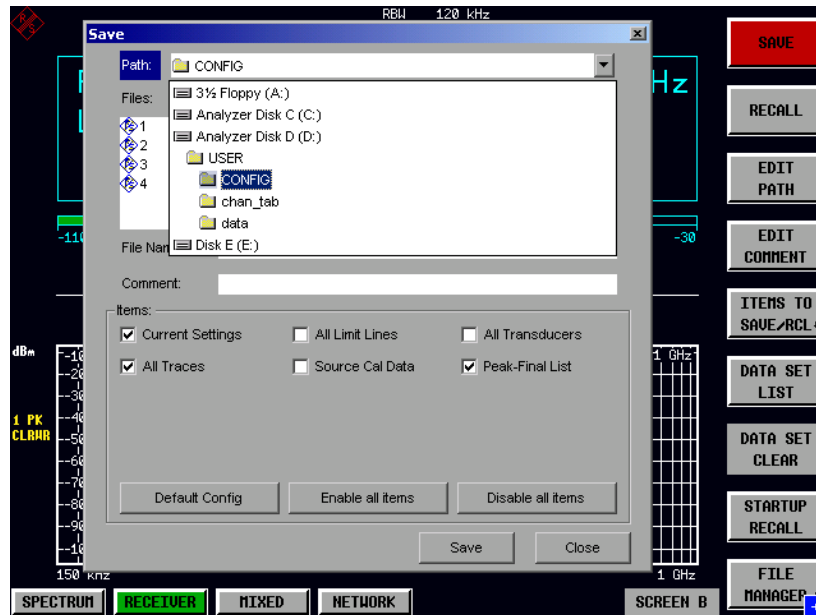

The *EDIT PATH* softkey activates the entry of a path name for the device configuration to be stored/to be loaded:



The desired directory is selected with the spinwheel or the *CURSOR UP / DOWN* key and is confirmed by pressing the spinwheel or the *ENTER* key.

Subdirectories are opened by the *CURSOR RIGHT*  key and closed with the *CURSOR LEFT*  key.

IEC/IEEE-bus command -

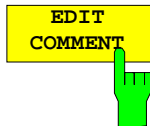

The *EDIT COMMENT* softkey activates the entry of commentary concerning the current data set. The help line editor is opened with *CURSOR DOWN*. A total of 60 characters are available for this purpose.

Note:

For further information on how to enter the comment text via the front panel of the unit, see the section "Entering Text using the Help Line Editor".

IEC/IEEE command: MMEM:COMM "Setup fuer GSM Messung"

The *SEL ITEMS TO SAVE/RCL* softkey opens a submenu for selecting the data subsets.

FILE - ITEMS TO SAVE/RCL submenu:

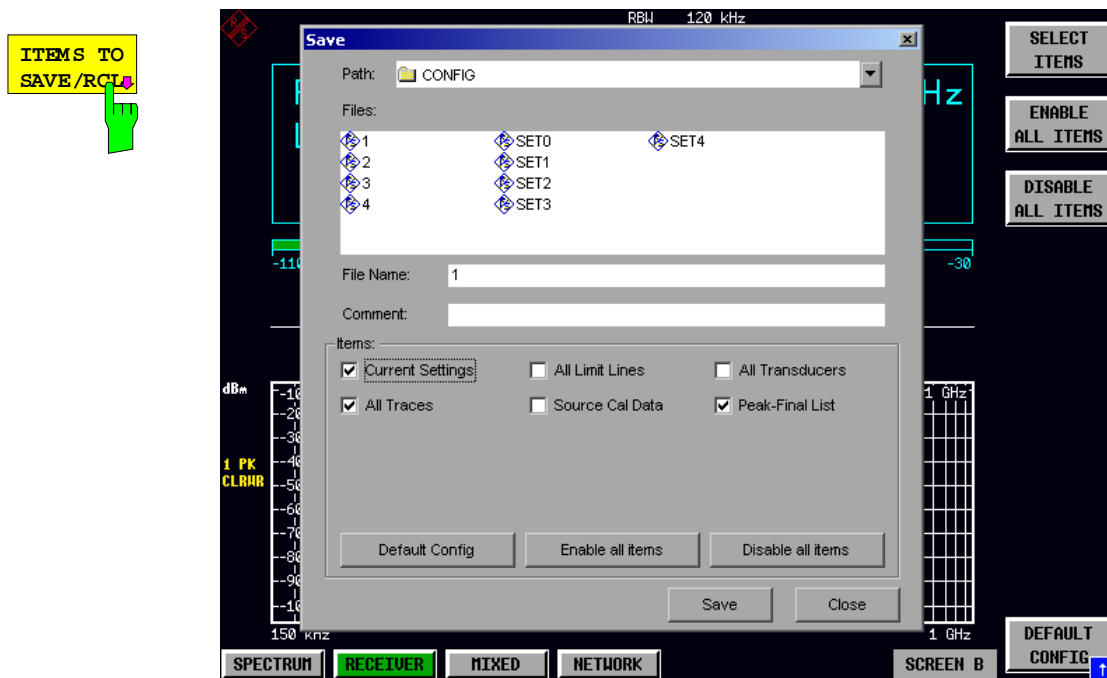

The Dialog *SaveL* table offers the following selectable data subsets in the *Items* field:
Current Settings

These settings include:

- current configuration of general instrument parameters
- current measurement hardware settings
- active limit lines:
 A data set may contain maximum 8 limit lines for each window. It always contain the activated limit lines and the de-activated limit lines used last, if any.
 Consequently, the combination of the restored de-activated limit lines depends on the sequence of use with command `MMEM : LOAD`.
- the activated transducer factor
- user-defined colour settings
- configuration for hardcopy output
- active transducer:
 A data set may contain maximum 4 transducer factors. It always contain the activated factors and the factors used and de-activated last, if any. Consequently, the combination of the restored de-activated transducer factors depends on the sequence of use with the command `MMEM : LOAD`.
- peak list or final measurement results (receiver mode)
- settings of tracking generator (only with option tracking generator)
- settings of tracking generator (only with option)

All Limit Lines
All Transducers
All Traces
Source Cal Data

all limit lines
 all transducer
 all traces which are not blanked
 correction data for tracking generator (only with options B9 / B10)

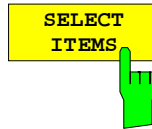

The *SELECT ITEMS* softkey moves the selection bar to the first line, left column of the *Items* field. An entry is selected. Position the entry focus to the corresponding partial data set using the cursor keys and then press the *ENTER* key in the desired line. The selection is cleared by pressing the key again.

IEC/IEEE command:

Current Settings:	MMEM:SEL:HWS ON
All Limit Lines:	MMEM:SEL:LIN:ALL ON
All Traces:	MMEM:SEL:TRAC ON
Source Cal Data:	MMEM:SEL:SCD ON



The *ENABLE ALL ITEMS* softkey marks all partial data sets.

IEC/IEEE command: MMEM:SEL:ALL

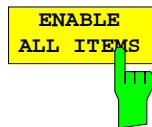

The *ENABLE ALL ITEMS* softkey marks all partial data sets.

IEC/IEEE-bus command MMEM:SEL:ALL

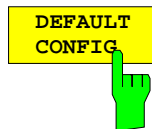

The *DEFAULT CONFIG* softkey establishes the default selection of the data subset to be saved and outputs *DEFAULT* in the *ITEMS* field of the *SAVE/RECALL DATA SET* table.

IEC/IEEE command: MMEM:SEL:DEF

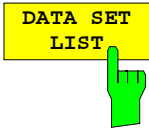

The *DATA SET LIST* softkey sets the entry focus to the list *Files* of all available data sets. In addition, the *DATA SET CLEAR* softkey are displayed.

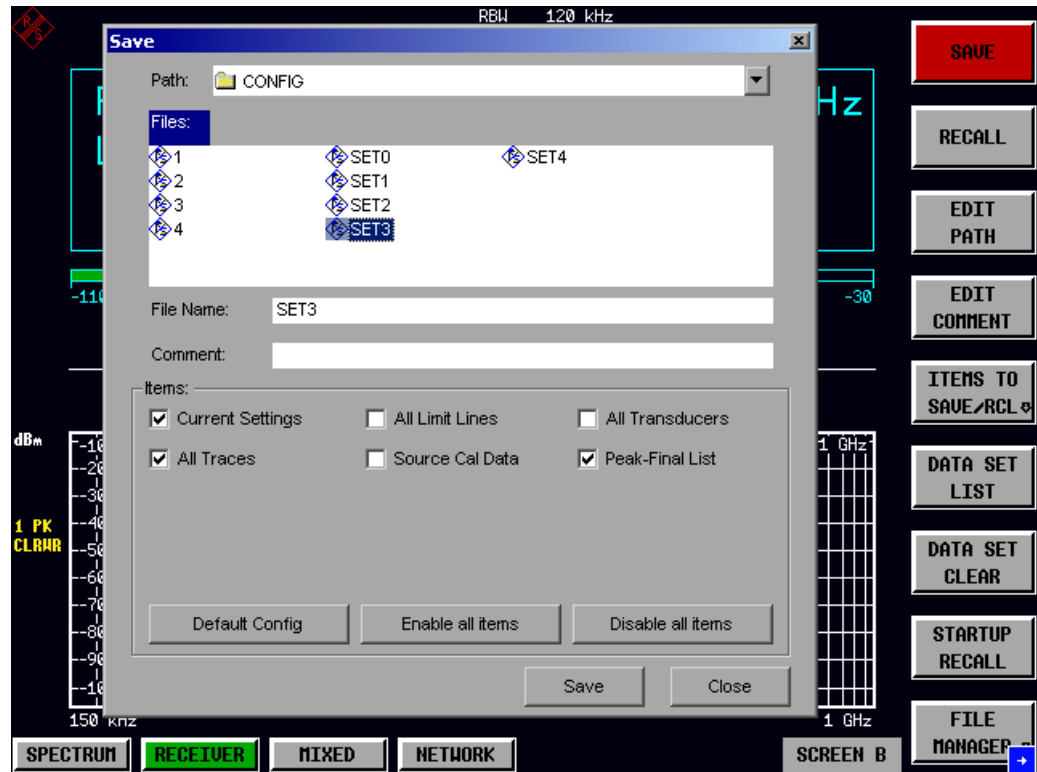

The list *Files* lists all data sets which are stored in the selected directory.

The *Comment* and *Items* fields in the *DATA SET CONTENTS* column indicate the saved data subsets and the comment for the currently selected data set.

IEC/IEEE command: ---

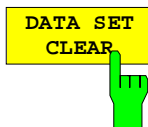

The *DATA SET CLEAR* softkey deletes the selected data set

IEC/IEEE command: `MMEM:CLE:STAT 1, "test03"`

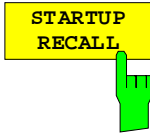

The *STARTUP RECALL* softkey activates the selection of a data set which is automatically loaded when the instrument is powered on and after *PRESET*. For this purpose the Dialog *Startup Recall* is opened (analogously to *DATA SET LIST*).

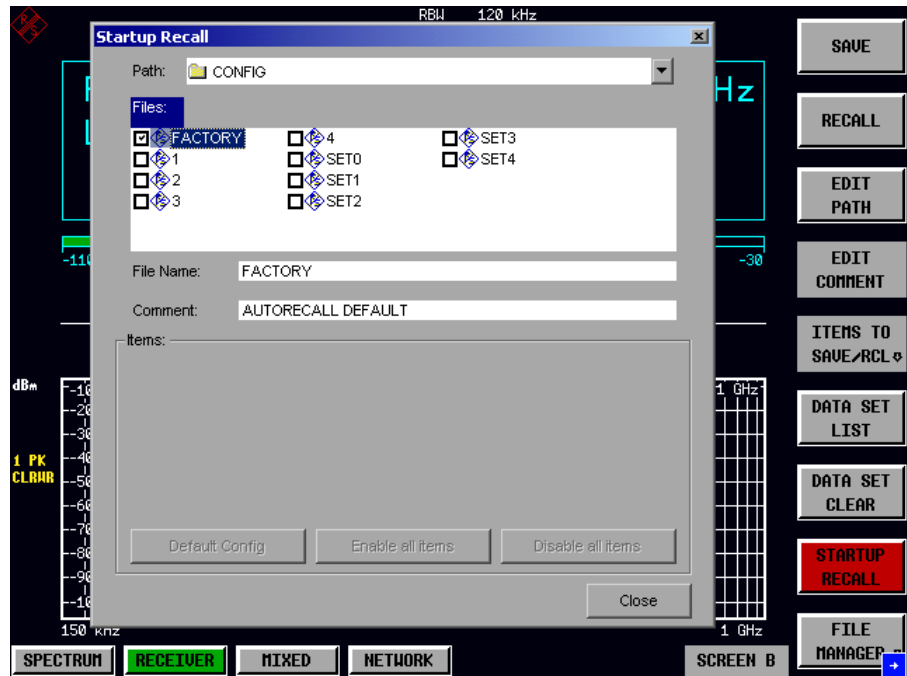

The field *Files* lists all data sets stored in the selected directory. The currently selected data set is checked.

In addition to the data sets stored by the user, the data set *FACTORY*, which specifies the settings of the instrument before it was last switched off (Standby), is always present (when unit is delivered).

To select a data set, the entry focus is set to the corresponding entry by means of the spinwheel and the data set is activated by pressing the spinwheel or the *ENTER* key.

If a data set other than *FACTORY* is chosen, this data set will be loaded when the unit is switched on or after pressing the *PRESET* key. Any settings can be assigned to the *PRESET* key.

IEC/IEEE command: `MMEM:LOAD:AUTO 1, "D:\user\config\test02"`

Operating Concept of File Managers

The *FILE MANAGER* softkey opens a menu for managing storage media and files.

FILE - FILE MANAGER submenu:

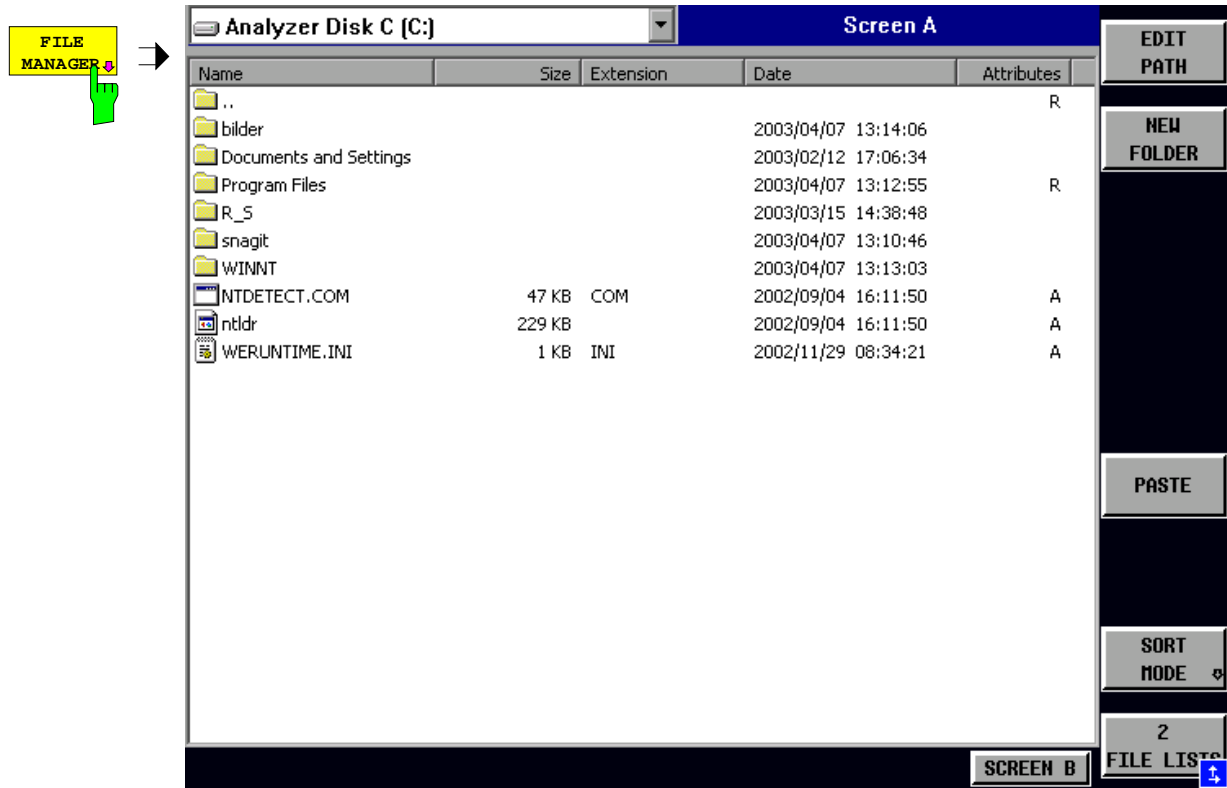

The designation and the letter of the current drive are displayed in the upper left corner of the File Manager dialog.

The table below shows the files of the current directory and potential subdirectories.

A file or a directory in the table is selected via cursor keys. The *ENTER* key is used to switch from one subdirectory to another.

The softkeys *COPY*, *RENAME*, *CUT* and *DELETE* are only visible if the entry focus is set to a file and not to a directory.

The dots *..* open up the next higher directory.

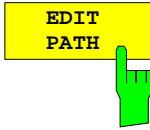

The *EDIT PATH* softkey activates the input of the directory which will be used in subsequent file operations.

The new path is included in the *FILE MANAGEMENT* table.

		Date	Attributes
		2003/04/07 22:01:01	
		2003/04/07 22:20:51	A
		2003/04/07 22:00:54	A
		2003/04/07 22:31:39	A
		2003/04/07 22:01:01	A
SET0.FSP	117 KB FSP	2003/04/07 22:00:27	A
SET1.FSP	117 KB FSP	2003/04/07 22:00:22	A
SET2.FSP	117 KB FSP	2003/04/07 22:00:34	A
SET3.FSP	117 KB FSP	2003/04/07 22:00:38	A
SET4.FSP	117 KB FSP	2003/04/07 22:00:45	A

Use *CURSOR UP / DOWN* to select a drive and confirm your selection with *ENTER*.

Open subdirectories by using *CURSOR RIGHT*, and use *CURSOR LEFT* to close them again.

When you have found the subdirectory you looked for, mark it with *ENTER*.

IEC/IEEE command: MMEM:MSIS "a:"
 MMEM:CDIR "D:\user "

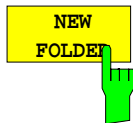

The *NEW FOLDER* softkey creates subdirectories.

The entry of an absolute path name (e.g. "USER\MEAS") as well as the path relative to the current directory (e.g. "..\MEAS") is possible.

IEC/IEEE command: MMEM:MDIR "D:\user\test"

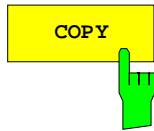

The *COPY* softkey opens the help line editor to enter the target directory for a copying process. The file is also copied into the clipboard and can be copied into a different directory at a later time by means of *PASTE*.

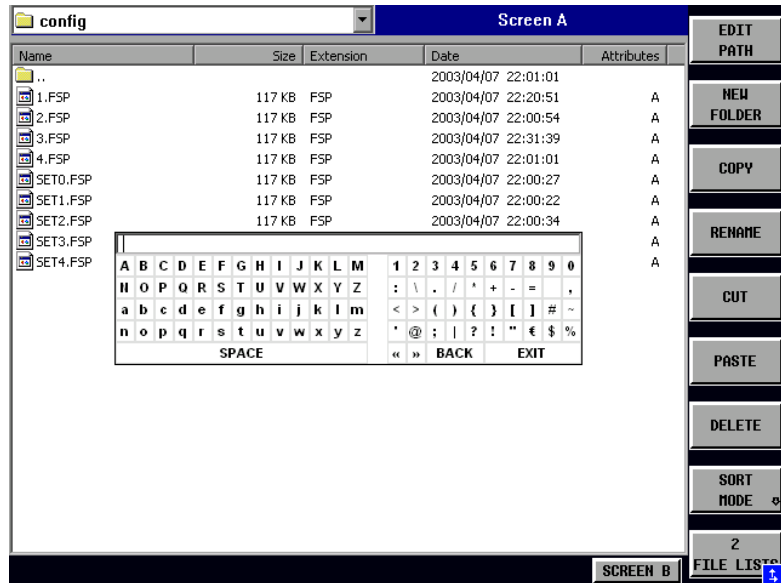

Files can also be copied to a different storage medium by indicating a certain drive letter (e.g. D:). The selected files or directories will be copied after terminating the entry with the ENTER key.

IEC/IEEE-bus command `MMEM:COPY "D:\user\set.cfg", "a:"`

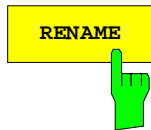

The *RENAME* softkey opens the help line editor to rename a file or a directory (analogously to the *COPY* softkey).

IEC/IEEE command: `MMEM:MOVE "test02.cfg", "set2.cfg"`

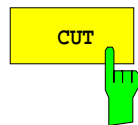

The *CUT* softkey shifts the selected file into the clipboard from where it can be copied into a different directory at a later time by means of *PASTE*.

Note:

The file in the output directory will only be deleted if the *PASTE* softkey has been pressed.

IEC/IEEE-bus command -

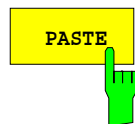

The *PASTE* softkey copies files from the clipboard to the current directory. The directory is changed by means of the cursor keys and subsequent pressing of *ENTER* or via the *EDIT PATH* softkey.

IEC/IEEE-bus command -

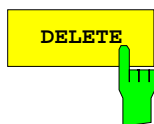

The *DELETE* softkey deletes the selected file.

A confirmation query is displayed to avoid unintentional deletion of files.

IEC/IEEE-bus command `MMEM:DEL "test01.hcp"`
`MMEM:RDIR "D:\user\test"`

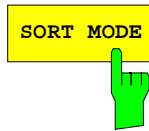

The *SORT MODE* softkey opens the submenu to select the sorting mode for the displayed files.

config					Screen A		NAME
Name	Size	Extension	Date	Attributes			DATE
..			2003/04/07 22:47:33				EXTENSION
autolog.txt	2 KB	txt	2000/09/27 12:14:28	A			SIZE
1.FSP	117 KB	FSP	2003/04/07 22:20:51	A			
2.FSP	117 KB	FSP	2003/04/07 22:00:54	A			
3.FSP	117 KB	FSP	2003/04/07 22:31:39	A			
4.FSP	117 KB	FSP	2003/04/07 22:01:01	A			
SET0.FSP	117 KB	FSP	2003/04/07 22:00:27	A			
SET1.FSP	117 KB	FSP	2003/04/07 22:00:22	A			
SET2.FSP	117 KB	FSP	2003/04/07 22:00:34	A			
SET3.FSP	117 KB	FSP	2003/04/07 22:00:38	A			
SET4.FSP	117 KB	FSP	2003/04/07 22:00:45	A			

Directory names are located at the top of the list after the entry for the next higher directory level ("..").

IEC/IEEE command: --

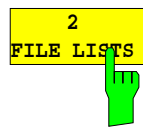

The *2 FILE LISTS* softkey opens a second window for the File Manager. The entry focus can be moved between the two windows by means of hotkeys *SCREEN A* and *SCREEN B*. Files can thus very easily be copied and shifted from one directory to the other.

Note:

The second file list can also be opened in the Full Screen mode via hotkey *SCREEN B* or *SCREEN A*.

IEC/IEEE-bus command -

FILE - NEXT menu:



The *ASCII FILE EXPORT* softkey stores the active trace in ASCII format to a disk.

IEC/IEEE-bus command: FORM ASC;
 MMEM:STOR:TRAC 1, 'TRACE.DAT'

The file consists of a header, which contains important scaling parameters, and a data section, which contains the trace data.

The file header data comes in three columns separated by semicolons (;). It has the following contents:

parameter name; numerical value; default unit

The data section starts with the keyword "Trace <n>", where <n> designates the number of the trace to be stored. This is followed by the measured data in columns separated by semicolons (;).

This format can be read by spreadsheet programs such as MS Excel. A semicolon (;) is to be defined as a separator between the cells of a table.

Note: *Analysis programs may come in different language versions that require different notations of the decimal point. By means of the DECIM SEP softkey, a decimal point (.) or a comma (,) can be selected as decimal-point notation.*

For a detailed description of the ASCII file format, refer to section "Selection and Setting of Traces – TRACE Key", ASCII FILE EXPORT softkey.

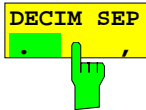

By means of the *DECIM SEP* softkey, one can select between a decimal point (.) and a comma (,) as decimal-point notation for the ASCII FILE EXPORT function.

Due to the possibility of selecting between different decimal-point notations, different language versions of analysis programs (such as MS Excel) can be supported.

IEC/IEEE-bus command: FORM:DEXP:DSEP POIN

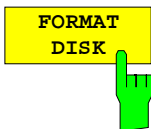

The *FORMAT DISK* softkey formats disks located in drive A:.

To prevent accidental destruction of disk data, confirmation by the user is requested.

IEC/IEEE command: MMEM:INIT "a:"

Measurement Documentation – *HCOPY* Key

Note: The installation of additional printers is described together with the *INSTALL PRINTER* softkey.

HCOPY menu

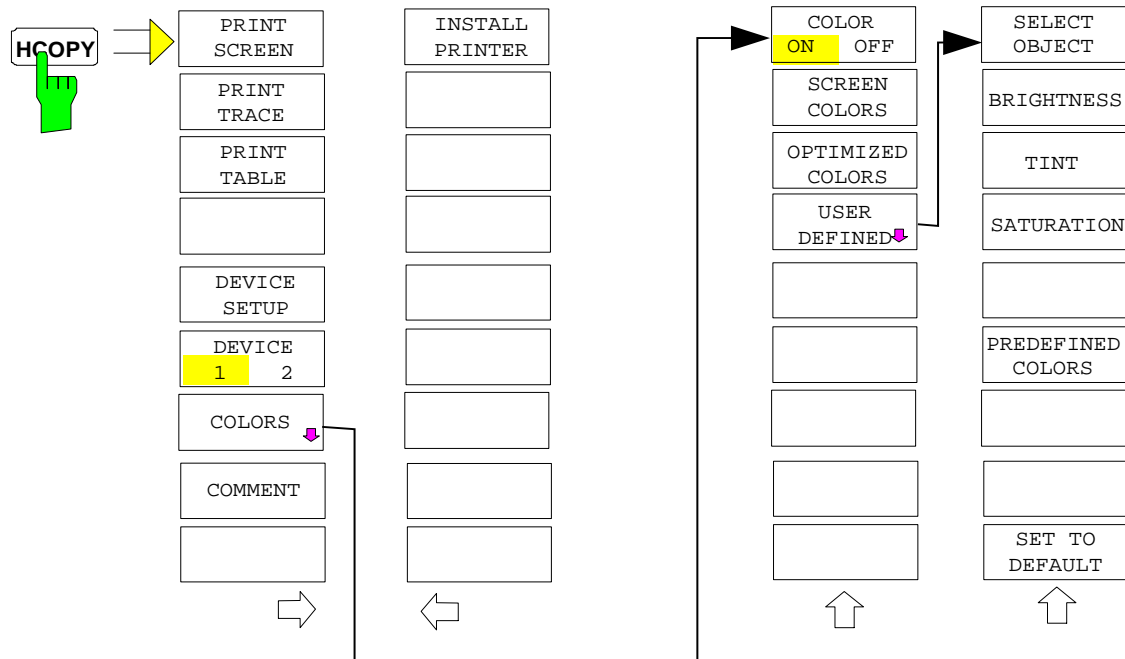

The *HCOPY* key opens the *HARDCOPY* menu for starting and configuring the printout.

Pressing one of the softkeys *PRINT*, *SCREEN*, *PRINT TRACE* or *PRINT TABLE* in the *HCOPY* menu initiates the print job. The printer parameters defined in the *DEVICE SETTINGS* menu are used for setting up the printer configuration. All of the display items to be printed are written to the printer buffer. Since the printer runs in the background, the instrument may be operated immediately after pressing the *PRINT...* softkey.

With *PRINT SCREEN* selected, all the diagrams with traces and status displays are printed as they occur on the screen. Softkeys, open tables and data entry fields are not printed.

The *PRINT TRACE* function allows individual traces to be printed. With *PRINT TABLE*, tables can be printed.

The *DEVICE 1* and *2* softkeys are used for selecting and configuring the output interface.

If the *PRINT TO FILE* option in the *DEVICE SETTINGS* table is selected, the printout is directed to a file. Upon pressing one of the *PRINT...* softkeys, the file name to which the output data is to be written is requested. An entry field is then opened for entering the file name.

The *COLORS* submenu allows switchover between black-and-white and colour printouts (default), provided that the printer connected can produce colour printouts. In addition, the colours are set in this submenu.

- **SCREEN** Output in screen colours.
- **OPTIMIZED (default)** Instead of light colours, dark colours are used for traces and markers: trace 1 blue, trace 1 black, trace 3 green, markers turquoise.
- **USER DEFINED** This option enables the user to change the colours at will. It provides the same setting functions as the *DISPLAY – CONFIG DISPLAY – NEXT* menu.

- Notes:**
1. With *SCREEN* and *OPTIMIZED* selected, the background will always be white and the grid black. With *USER DEFINED*, these colours can be selected, too.
 2. Upon activation of the submenu, the colour display is switched over to the selected printout colours. When the menu is quit, the original colour setting is restored.

The *COMMENT SCREEN A* and *COMMENT SCREEN B* softkeys allow text to be added to the printout (date and time are inserted automatically).

Use the *INSTALL PRINTER* softkey to install additional printer drivers.

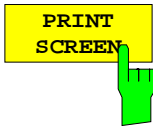

The *PRINT SCREEN* softkey starts the output of test results.

All the diagrams, traces, markers, marker lists, limit lines etc are printed out as long as they are displayed on the screen. All the softkeys, tables and open data entry fields are not printed out. Moreover, comments, title, date, and time are output at the bottom margin of the printout .

IEC/IEEE-bus command: `HCOP:ITEM:ALL`
`HCOP:IMM`

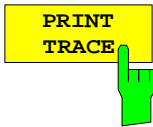

The *PRINT TRACE* softkey starts the output of all curves visible on the display screen without auxiliary information. Specifically, no markers or display lines are printed.

IEC/IEEE-bus command: `HCOP:ITEM:WIND:TRAC:STAT ON`
`HCOP:IMM`

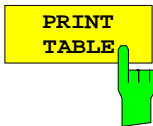

The *PRINT TABLE* softkey starts the output of all tables and info lists visible on the display screen without the measurement diagrams and other information lying behind.

IEC/IEEE-bus command: `HCOP:ITEM:WIND:TABL:STAT ON`
`HCOP:IMM`

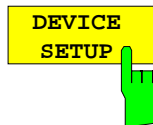

The *DEVICE SETUP* softkey opens the dialog where the file format and the printer can be selected (see section "Selecting Printer, Clipboard and File Formats").

IEC/IEEE-bus commands: `HCOP:DEV:LANG GDI;`
`SYST:COMM:PRIN:ENUM:FIRS?;`
`SYST:COMM:PRIN:ENUM:NEXT?;`
`SYST:COMM:PRIN:SEL <Printer>;`
`HCOP:PAGE:ORI PORT;`
`HCOP:DEST "SYST:COMM:PRIN";`
`HCOP:DEST "SYST:COMM:MMEM"`

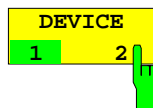

The analyzer is able to manage two hardcopy settings independently of each other. They are selected via the *DEVICE 1 / 2* softkey, which displays also the associated setting if the *DEVICE SETUP* dialog is open.

IEC/IEEE-bus command: `--`

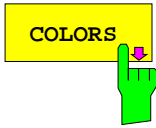

The *COLORS* softkey gives access to the submenu where the colours for the printout can be selected (see section "*Selecting Printer Colours*").

IEC/IEEE-bus command: -

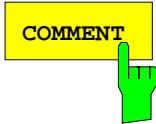

The *COMMENT* softkey opens an entry field in which a comment of two lines (60 characters per line) can be entered for screen A or B.

If the user enters more than 60 characters, the excess characters appear on the second line on the print-out. At any point, a manual line-feed can be forced by entering the @ character.

The comment is printed below the diagram area. The comment text appears on the hardcopy, but not on the display screen.

If a comment should not be printed, it must be cleared.

If the instrument is reset by a click on the PRESET key, all entered comments are cleared.

Note:

The COMMENT softkey opens the auxiliary line editor where the desired letters can be entered in the text field by means of spinwheel and cursor keys.

After clicking the *COMMENT* softkey, the auxiliary line editor can be reached with the  key. Pressing the spinwheel or the *ENTER* key inserts the selected characters in the text line.

After editing is completed, return to the text line with the  key and confirm the comment text with *ENTER*.

If the entered comment should be aborted, quit the auxiliary line editor with *ESC*.

Important:

Only after the auxiliary line editor has been closed with *ESC* can the softkeys and hardkeys be operated again.

A detailed description of the auxiliary line editor can be found in section "Entering a Text with the Auxiliary Line Editor".

IEC/IEEE-bus command: `HCOP:ITEM:WIND2:TEXT 'Comment'`

HCOPY NEXT menu:



A certain number of printer drivers is already installed on the R&S ESCI.

The *INSTALL PRINTER* softkey opens the *Printers and Faxes* dialog where more printer drivers can be installed.

For details refer to sections "Installation of Plug&Play Printers" and "Installation of Non-Plug&Play Printers".

IEC/IEC-bus command: -

Selecting Printer, Clipboard and File Formats

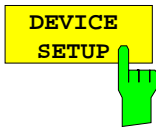

The *DEVICE SETUP* softkey opens the selection dialog for file format and printer.

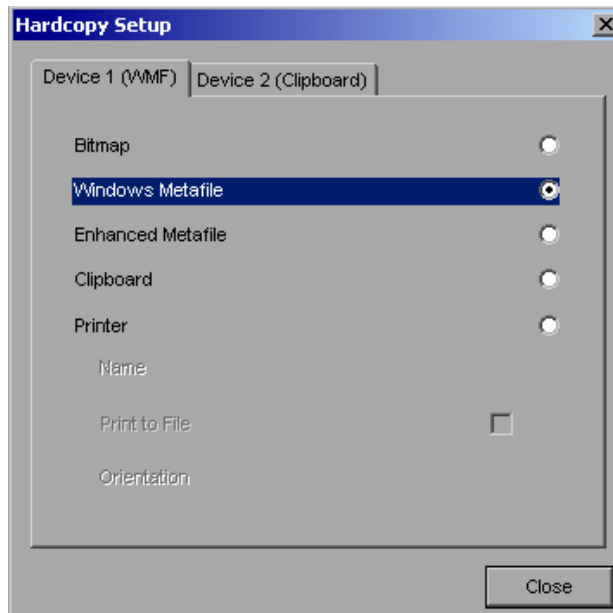

Navigation in the dialog is possible by turning the spinwheel; selection of an item is confirmed by pressing the spinwheel or the *ENTER* key.

The dialog is closed with *ESC* (alternatively, the *Close* button can be selected with the spinwheel and the dialog can be closed by pressing the spinwheel or with *ENTER*).

File formats

A file format is selected by turning the spinwheel and then confirmed by pressing the spinwheel or the *ENTER* key.

The following file formats can be selected:

BITMAP	BMP format (non-compressed)
WINDOWS METAFILE	Vector format, supported as of Windows 3.1
ENHANCED METAFILE	Vector format, supported as of Windows 95/98/ME/NT/XP

When a file format is selected, printing to a file is automatic. The file name is queried when the *PRINT SCREEN*, *PRINT TRACE* and *PRINT TABLE* softkeys are pressed.

Clipboard

A clipboard is also selected with the spinwheel and then confirmed by pressing the spinwheel or *ENTER* key.

After the *PRINT SCREEN*, *PRINT TRACE* or *PRINT TABLE* softkey has been pressed, printout is routed to the clipboard. With the aid of the "Process - Insert" function, the information in the clipboard can then be pasted into other programs, e.g. *Paint*, and subsequently processed.

Printer

A printer (also a preconfigured network printer) is selected by selecting *Printer* with the spinwheel and then confirmed by pressing the spinwheel or the *ENTER* key.

After confirmation, the entries under *Name*, *Print to File* and *Orientation* are available for selection with the spinwheel.

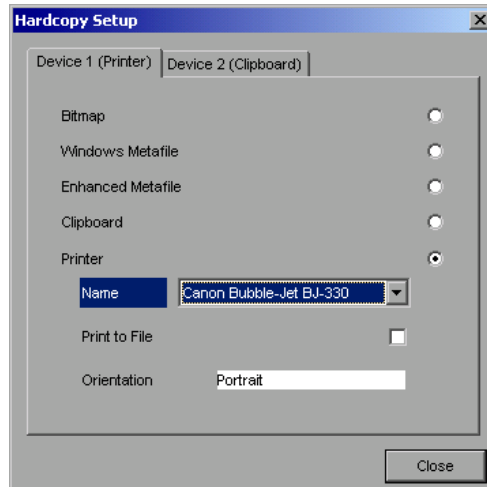

To select the printer type, select *Name* and open the selection list by pressing the spinwheel or *ENTER*.

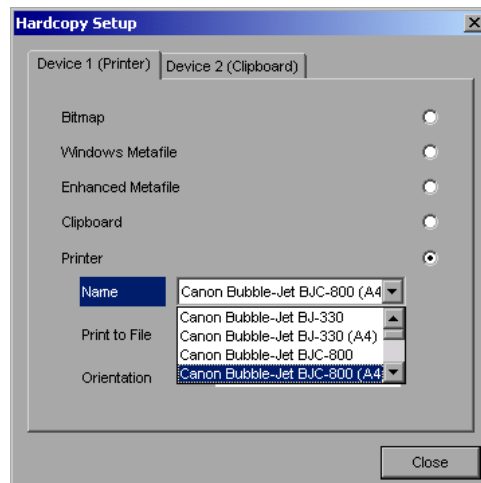

Select the desired printer (in the example "Cannon Bubble-Jet BJC800 (A4)") from the list by means of the spinwheel and confirm by pressing the spinwheel or *ENTER*. This closes the list and the cursor is placed on the *Name* field again.

Printing to a file is also possible. In this case select *Print to File* with the spinwheel and activate or deactivate the associated list by pressing the spinwheel or the *ENTER* key.

The printing format is selected under *Orientation*. In this case, too, pressing the spinwheel or *ENTER* opens the selection list.

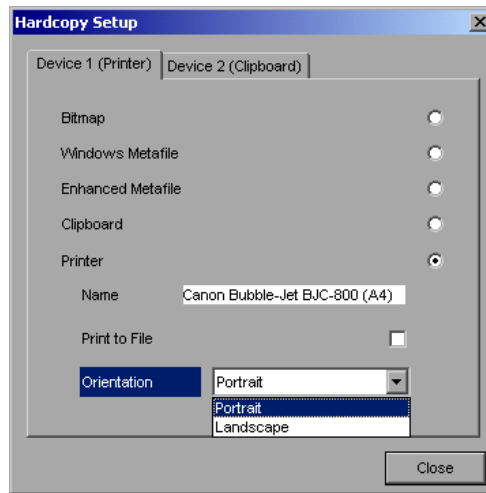

The desired format (here *Portrait*) is selected in the list with the spinwheel and confirmed by pressing the spinwheel or *ENTER*. This closes the list and the cursor is placed again on the *Orientation* field.

The dialog is then closed with *ESC* or by clicking the *Close* button.

Note: The installation of new printer types is described in sections "Local Printer" and "Configuring a Network Printer"

Selecting Alternative Printer Configurations

The analyzer is capable of managing two independent hardcopy settings. This, for instance, permits fast switchover between printing to a file or by a printer.

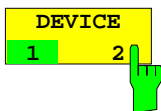

A selection is made with the *DEVICE 1 / 2* softkey which also shows settings when the *DEVICE SETUP* dialog is open.

IEC/IEEE-bus command: --

Selecting Printer Colours

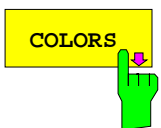

The *COLORS* softkey gives access to the submenu where the colours for the printout can be selected. To facilitate colour selection, the selected colour combination is displayed when the menu is entered. The previous colours are restored when the menu is exited.

IEC/IEEE-bus command: -

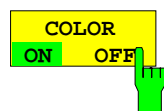

The *COLOR ON OFF* softkey switches over from colour output to black-and-white output. All colour-highlighted areas are printed in white and all colour lines in black. This improves the contrast on the printout. The default setting is *COLOR ON*.

IEC/IEEE-bus command: HCOP : DEV : COL ON

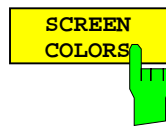

The *SCREEN COLORS* softkey selects the current screen colours for the printout.

Note: *The background is always printed in white and the grid in black.*

IEC/IEEE-bus command: HCOP : CMAP : DEF1

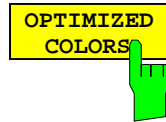

The *OPTIMIZED COLORS* softkey selects an optimized colour setting for the printout to improve the visibility of the colours on the hardcopy.

Trace 1 is blue, trace 2 black, trace 3 green, and the markers are turquoise.

The other colours correspond to the display colours of the *DISP – CONFIG DISPLAY -DEFAULT COLORS 1* softkey.

Note: *The background is always printed in white and the grid in black.*

IEC/IEEE-bus command: HCOP : CMAP : DEF2

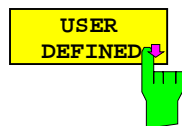

The *USER DEFINED* softkey opens a submenu for user-defined colour selection (see submenu *USER DEFINED COLORS*).

IEC/IEEE-bus command: HCOP : CMAP : DEF3

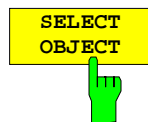

The *SELECT OBJECT* softkey allows picture elements to be selected to change their colour setting. After selection, the *PREDEFINED COLORS*, *BRIGHTNESS*, *TINT* and *SATURATION* softkeys enable the user to change the colours or brightness, the hue and the colour saturation of the element selected.

IEC/IEEE-bus command: -



The *BRIGHTNESS* softkey serves for determining the brightness of the graphic element selected.

A value between 0 and 100% can be entered.

IEC/IEEE-bus command:

HCOP : CMAP5 : HSL <hue> , <sat> , <lum>

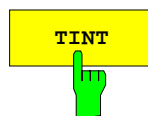

The *TINT* softkey serves for determining the hue of the element selected. The percentage entered refers to a continuous colour spectrum from red (0%) to blue (100%).

IEC/IEEE-bus command:

HCOP : CMAP5 : HSL <hue> , <sat> , <lum>



The *SATURATION* softkey serves for determining the saturation of the element selected.

A value between 0 and 100% can be entered.

IEC/IEEE-bus command:

HCOP:CMAP5:HSL <hue>,<sat>,<lum>



The *PREDEFINED COLORS* softkey opens a list from which predefined colours for the displayed elements can be selected:

COLOR	
√	BLACK
	BLUE
	BROWN
	GREEN
	CYAN
	RED
	MAGENTA
YELLOW	
	WHITE
	GRAY
	LIGHT GRAY
	LIGHT BLUE
	LIGHT GREEN
	LIGHT CYAN
	LIGHT RED
	LIGHT MAGENTA

IEC/IEEE-bus command:

HCOP:CMAP1 ... 26:PDEF <color>

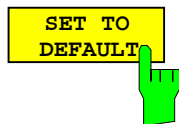

The *SET TO DEFAULT* softkey reactivates the default colour setting (= *OPTIMIZED COLORS*).

IEC/IEEE-bus command: -

Entering a Text with the Auxiliary Line Editor

The auxiliary line editor is opened automatically when the *COMMENT* softkey is clicked.



The entry area consists of two parts:

- the editing line
- the character selection field

Changeover from the editing line to the character selection is performed with the *cursor down* key.

Navigation in the character selection field is possible with the spinwheel or the cursor keys , , and .

Pressing the spinwheel or the *ENTER* key transfers the desired characters to the editing line.



The fields in the last line of the character selection field are assigned special functions.

- SPACE inserts a space in the editing line
- << shifts the cursor in the editing line by one character to the left
- >> shifts the cursor in the editing line by one character to the right
- BACK clears the character before the cursor
- EXIT stores the content of the editing line and closes the auxiliary line editor

Return to the editing line from the first line of the character selection field using the *cursor up* key.

Navigation within the editing line is also performed with the spinwheel or the cursor keys and .

Figures, decimal points and signs are directly entered in the editing line using the keypad on the front panel. When a PC keyboard is connected, letters and special characters can also be directly entered.

Editing is terminated from the editing line with *ENTER* if the text should be stored, and with *ESC* when the entered text should be aborted. In both cases the auxiliary line editor is closed.

Installation of Plug&Play Printers

The installation of Plug&Play printers under Windows XP is quite simple:

After the printer is connected and switched on, Windows XP automatically recognizes it and installs its driver, provided the driver is included in the XP installation.

If the XP printer driver is not found, Windows XP prompts you to enter the path for the corresponding installation files. In addition to pre-installed drivers, a number of other printer drivers can be found in directory D:\I386.

Note: When installing new printer drivers, you will be prompted to indicate the path of the new driver. This path may be on a disk in drive A. Alternatively, the driver can be loaded via a memory stick or USB CD-ROM drive (see section "Connection of USB Devices").

Installation of Non-Plug&Play Printers

Note: The dialogs below can be operated either from the front panel or via mouse and keyboard (see sections "Connecting a Mouse" and "Connecting a Keyboard"). *Mouse and PC keyboard are absolutely essential for configuring network printers.*

A new printer is installed via the *INSTALL PRINTER* softkey.

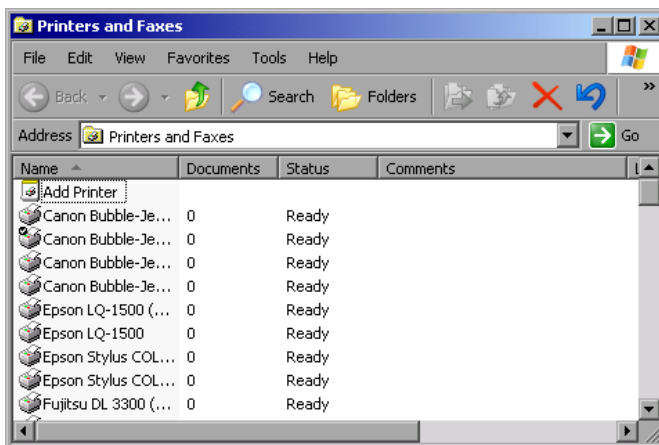

- Select *Add Printer* in the list using the spinwheel.
- Highlight the selected item with *CURSOR RIGHT* and press *ENTER* or the spinwheel to confirm the selection.

The *Add Printer Wizard* is displayed.



- Select *NEXT* with the spinwheel and press the spinwheel for confirmation.

Local or Network Printer can be selected.

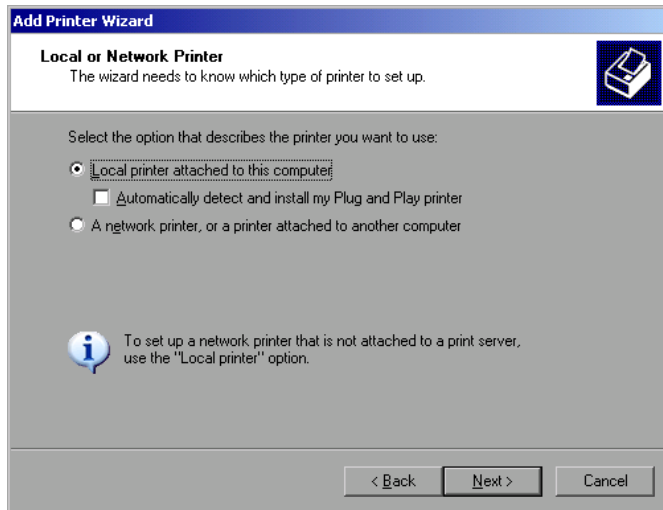

- To install a local printer, select *Local printer attached to this computer* with the spinwheel. Press the spinwheel for confirmation and continue with the "Local Printer" section.
- To install a network printer, select *A network printer, or a printer attached to another computer*. Press the spinwheel for confirmation and continue with the "Network Printer" section.

Local Printer

In the example below, a Star LC24 printer is installed.

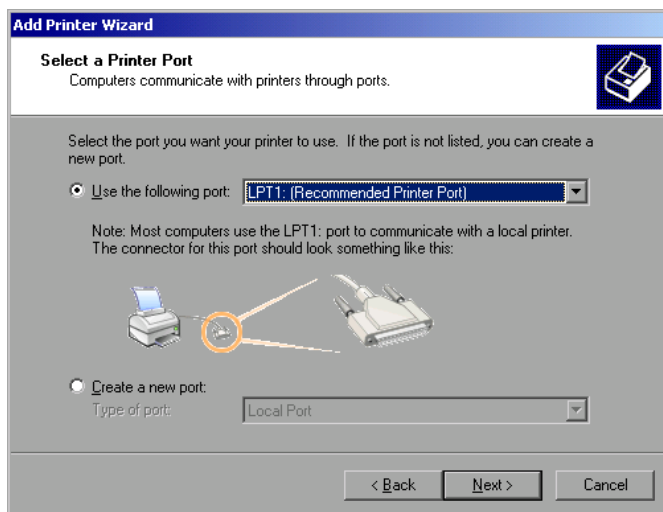

- To select the USB interface, open the list of ports by clicking the spinwheel. Select the printer port with spinwheel/arrow keys and confirm by pressing the spinwheel. The selection list is closed again.
 - To select the LPT connector, the selection list need not be opened.
 - Place the cursor on the *Next* button and confirm by pressing the spinwheel.
- The "Install Printer Software" dialog is opened.

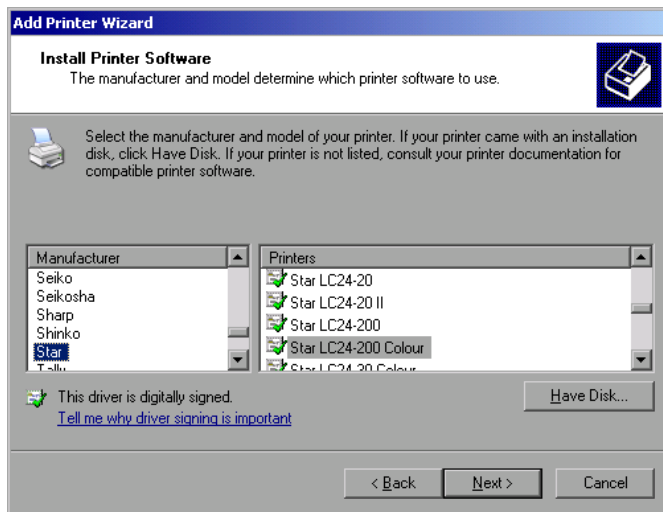

- Select the desired manufacturer ("Star") in the Manufacturer table using the up / down keys.

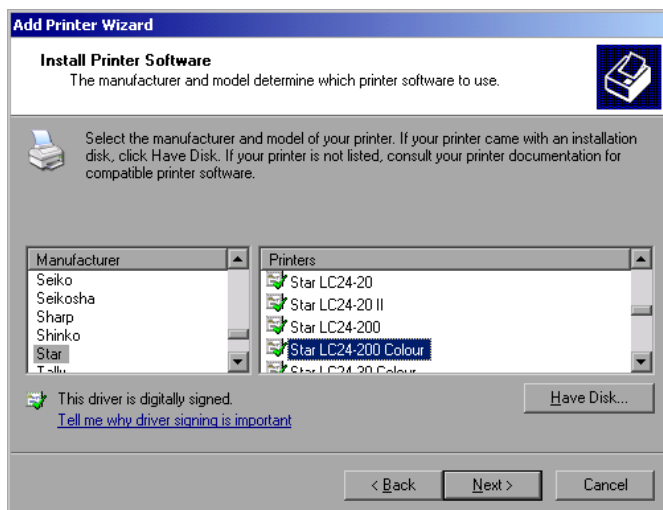

Go to the *Printers* list with the spinwheel.

- Select the desired printer type (Star LC24-200 Colour) using the up / down keys and confirm with *ENTER*.

Note:

If the desired printer type is not in the list, the respective driver is not installed yet. In this case click the HAVE DISK button with the mouse key. You will be prompted to insert a disk with the corresponding printer driver. Press OK and select the desired printer driver.

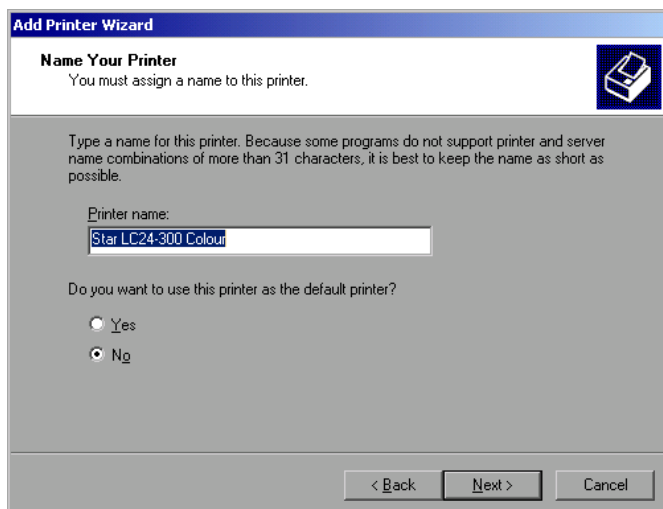

The printer name can be changed as required in the *Printer name* entry field (max. 60 characters). A PC keyboard is required in this case.

- Use the spinwheel to select *Yes* or *No* for the default printer.
- Choose the desired status with the up /down keys.
- Confirm with *ENTER*.

The *Printer Sharing* dialog is opened.

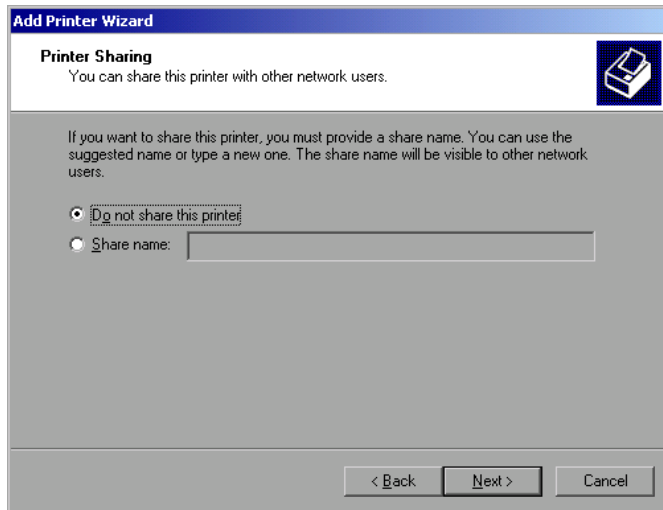

- Exit the dialog with *ENTER*.
The *Print Test Page* dialog is opened.

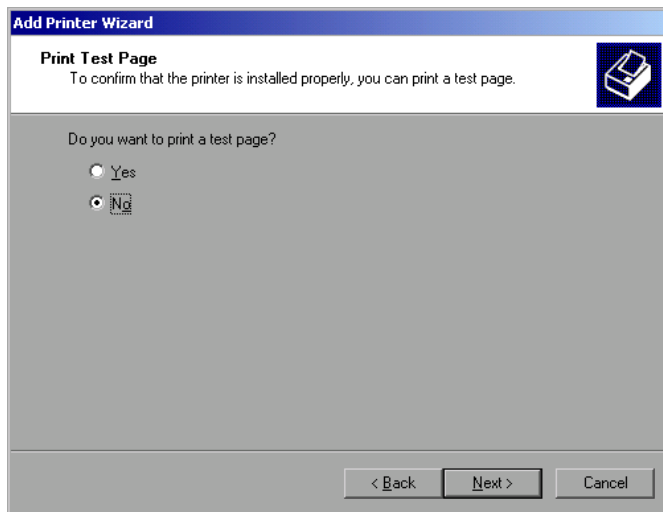

- Exit the dialog with *ENTER*.
The *Completing the Add Printer Wizard* dialog is opened.

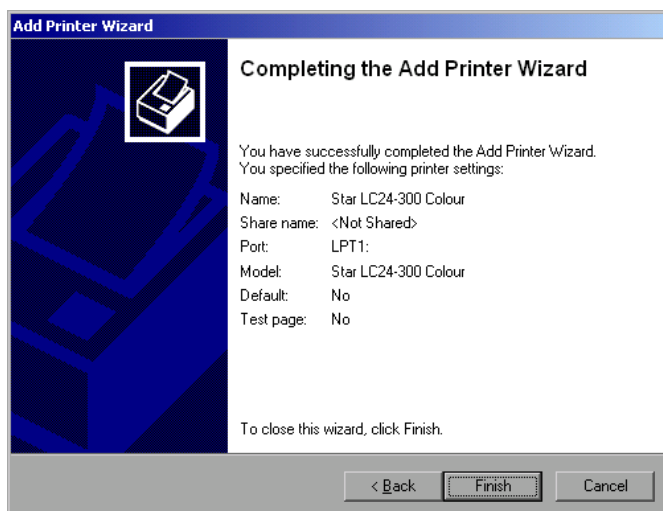

- Check the displayed settings and exit the dialog with *ENTER*.

The printer is installed. If Windows finds the required driver files, the installation is completed without any further queries.

If Windows cannot find the required driver files, a dialog is opened where the path for the files can be entered.

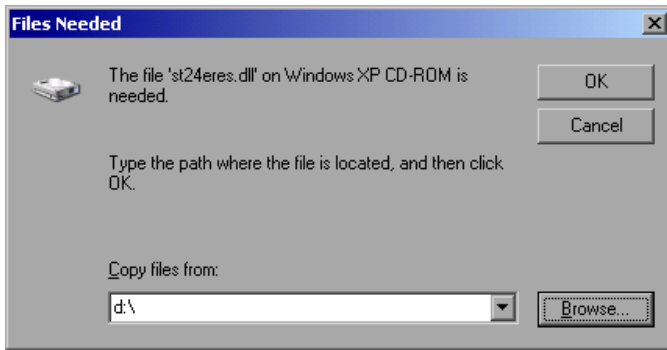

- Select the *Browse* button with the spinwheel and confirm with by pressing the spinwheel.

The *Locate File* dialog is opened.

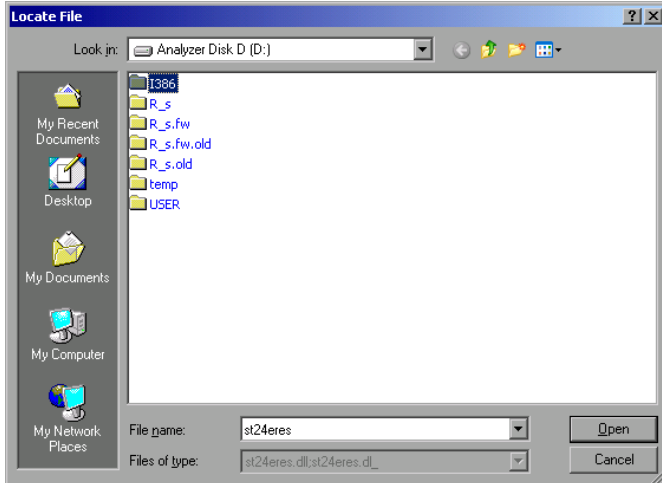

- Turn the spinwheel to select the directory and path D:\I386 and press it to confirm the selection.

If the selected item is not printed on a blue background, it must be marked with the cursor up / down keys before it can be activated by pressing the spinwheel.

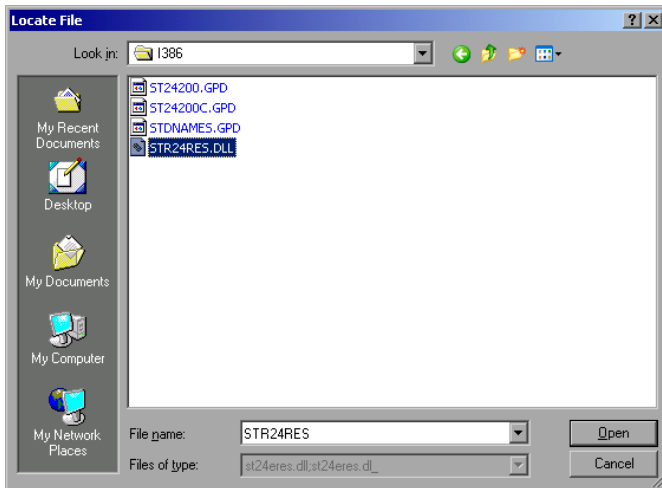

- Select the driver file with the spinwheel and confirm by pressing the spinwheel.

The file is included in the *Files Needed* dialog.

Note:

If the desired file is not in the D:\I386 directory, a disk with the driver file is needed. In this case, exit the dialog with ESC and repeat the selection starting from the "Files needed" dialog.

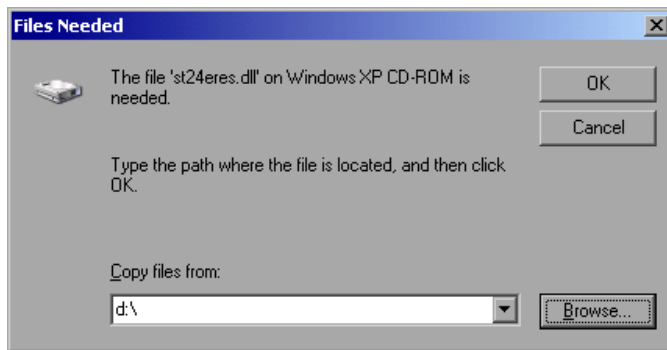

- Select the OK button with the spinwheel and press the spinwheel to confirm.

The installation is completed.

Finally the instrument must be configured for printouts of the measurement screen with this printer. For details please refer to the *DEVICE SETUP* softkey in the hardcopy menu.

Network Printer

Note: *For easy operation of the subsequent dialogs, connection of a PS/2 keyboard with trackball to the front panel is recommended. If no trackball is available, a USB mouse should be connected additionally to the rear panel (see section "Connecting a Mouse" and "Connecting a Keyboard")*

In the example below, a HP Laserjet 5 printer is installed as network printer. The Add Printer Wizard has already been opened as described in section " Starting the Add Printer Wizard "

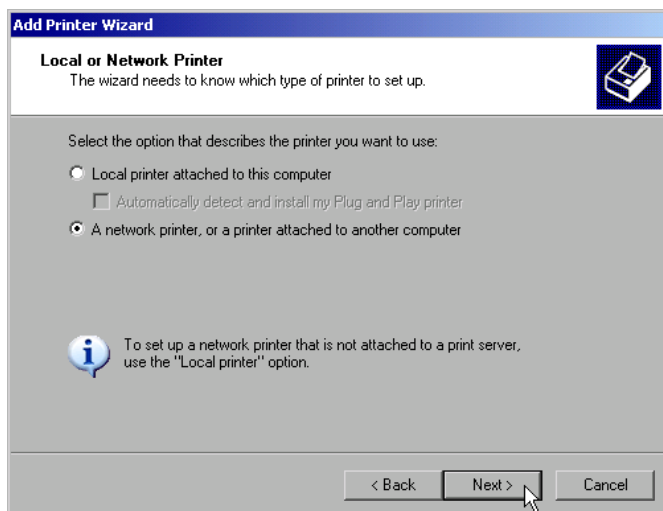

- To select a network printer, click the option "A network printer or a printer attached to another computer".

Continue with *Next*.

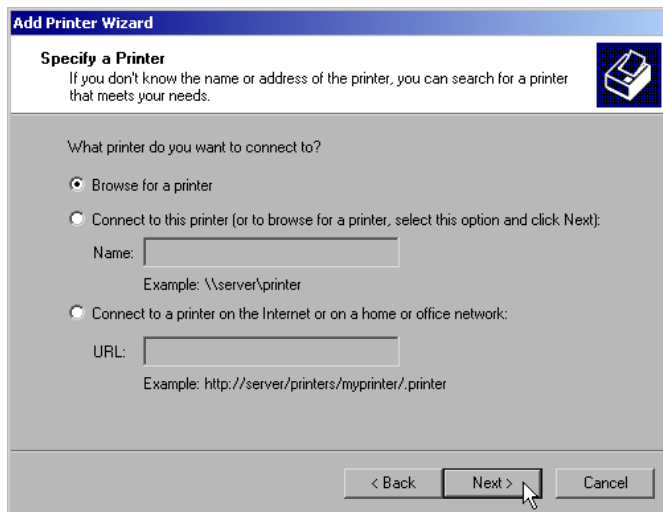

- Click *Browse for a printer* and then *Next*.
A list of selectable printers is displayed.

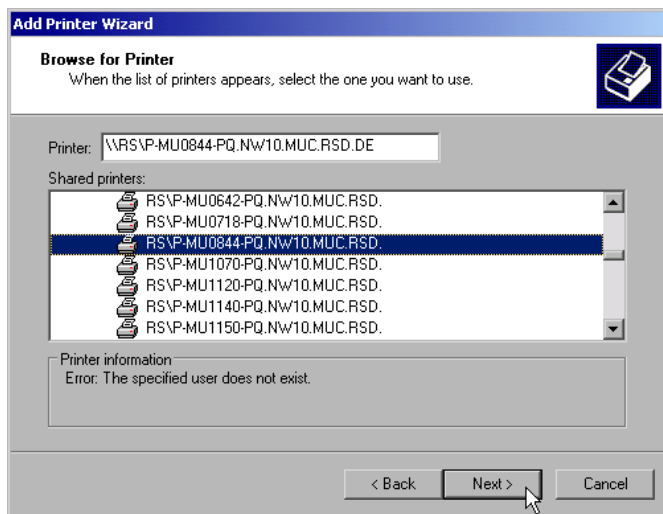

- Mark the desired printer and select it with *OK*.

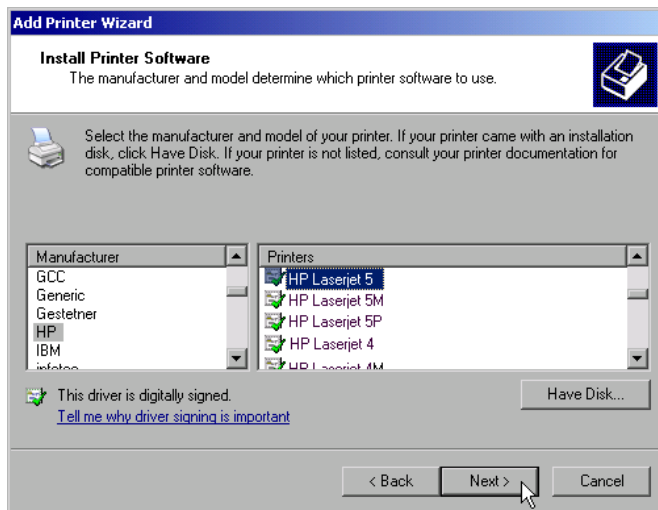

➤ Confirm the subsequent prompt to install a suitable printer driver with "OK". The list of available printer drivers is displayed.

The manufacturers are listed in the left-hand table, the available printer drivers in the right-hand table.

➤ Select the manufacturer from the *Manufacturers* table and then the printer driver from the *Printers* table.

Note:

If the desired type of output device is not shown in the list, the driver has not yet been installed. In this case, click the "HAVE DISK" button. You will be prompted to insert a disk with the corresponding printer driver. Insert the disk, select "OK" and then choose the desired printer driver.

➤ Click *Next*.

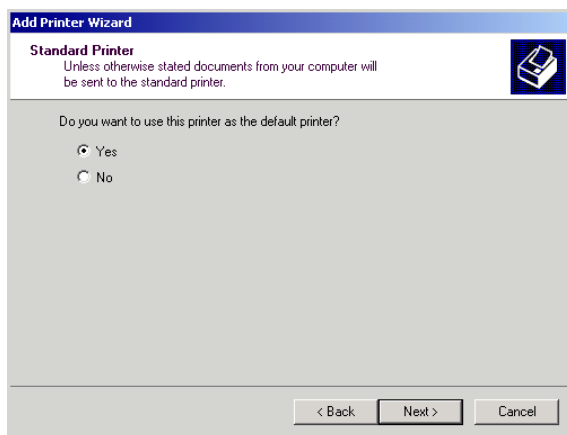

If one or more printers are already installed, a query is displayed whether the printer just installed should be used as the standard printer for the Windows XP applications. Default setting is *No*.

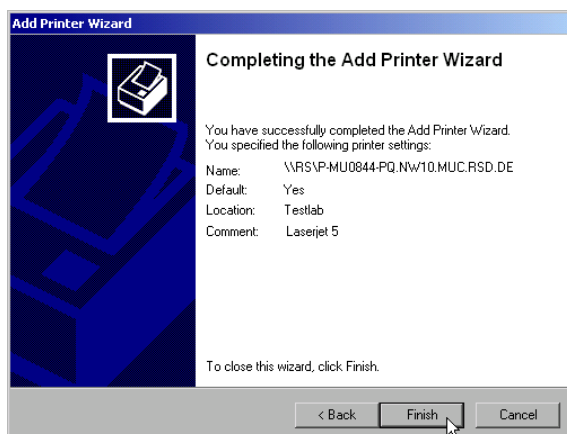

➤ Start the printer driver installation with *Finish*.

Finally, the instrument has to be configured for printout with this printer using the DEVICE SETUP and DEVICE 1/2 softkeys in the hardcopy main menu (see section "Selection of a Printer").

Tracking Generator - Option R&S FSP-B9

During normal operation (without a frequency offset), the tracking generator emits a signal exactly at the input frequency of the R&S ESCI.

For frequency-converting measurements it is possible to set a constant frequency offset of ± 150 MHz between the receive frequency of the R&S ESCI and the output signal of the tracking generator. Moreover, an I/Q modulation or AM and FM modulation of the output signal can be provided using two analog input signals.

The output power is level-controlled and can be set in 0.1 dB steps in a range from -30 dBm to 0 dBm.

The tracking generator can be used in all operating modes. Acquisition of test setup calibration values (SOURCE CAL) and normalization using these correction values (*NORMALIZE*) is only possible in the *NETWORK* operating mode.

Note: *The RF characteristics of some DUTs is especially sensitive concerning the input VSWR. In such cases insertion of 20 dB attenuation between the DUT and the tracking generator output is highly recommended.*

The tracking generator is activated by means of the NETWORK hotkey in the hotkey bar at the bottom of the screen:

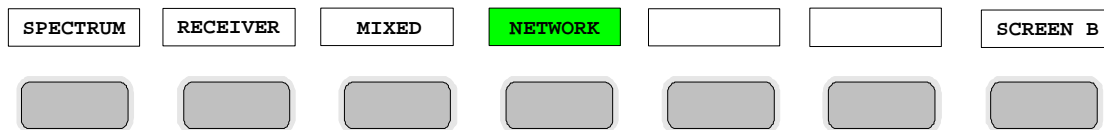

Tracking Generator Settings

The *NETWORK* hotkey opens a menu for selecting the functions of the tracking generator.

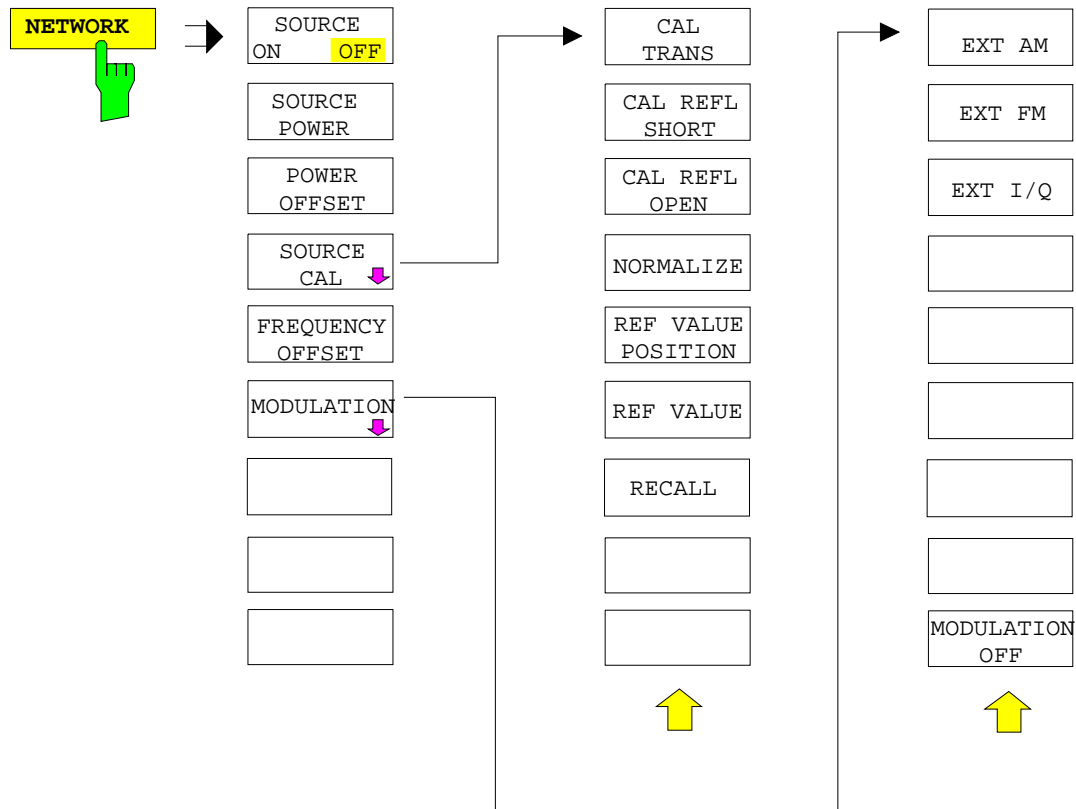

Note: Additional softkeys are available in the displayed menus for controlling an external generator if option External Generator Control FSP-B10 is fitted. For detailed information see section 'External Generator Control Option FSP-B10'.

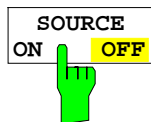

The *SOURCE ON/OFF* softkey switches the tracking generator on or off. Default setting is *OFF*

Note:

- When the tracking generator is switched on the maximum stop frequency is limited to 3 GHz. This upper limit is automatically reduced by a frequency offset set up for the tracking generator.
- In order to meet the data sheet accuracy for measurements with active tracing generator the start frequency must be set to $\geq 3 \times$ Resolution Bandwidth.
- The minimum sweeptime for measurements with data sheet accuracy is 100 ms in frequency domain (span > 0 Hz). Selecting a sweeptime below this limit will result in the sweeptime indicator field SWT being supplied with a red asterisc and the message UNCAL being displayed.
- FFT filters (FILTER TYPE FFT in BW menu) are not available when the tracking generator is active.

IEC/IEEE-bus command: OUPP:STAT ON

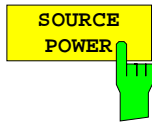

The *SOURCE POWER* softkey allows the tracking generator output power to be selected.

The output power can be set in 0.1 dB steps from -30 dBm to 0 dBm.

If the tracking generator is off, it is automatically switched on when an output power value is entered.

The default output power is -20 dBm.

IEC/IEEE-bus command: `SOUR:POW -20dBm`

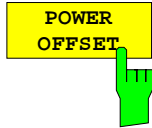

The *POWER OFFSET* softkey allows selection of a constant level offset for the tracking generator.

With this offset for example attenuators or amplifiers at the output connector of the tracking generator can be taken into account for the displayed output power values on screen or during data entry.

The valid range is -200 dB to +200 dB in 0.1 dB steps. Positive offsets apply to an amplifier and negative offsets to an attenuator subsequent to the tracking generator.

The default setting is 0 dB. Offsets $\neq 0$ will display the enhancement label **LVL**.

IEC/IEEE-bus command: `SOUR:POW:OFFS -10dB`

Transmission Measurement

This measurement will yield the transmission characteristics of a two-port network. The built-in tracking generator serves as a signal source. It is connected to the input connector of the DUT. The input of the R&S ESCI is fed from the output of the DUT.

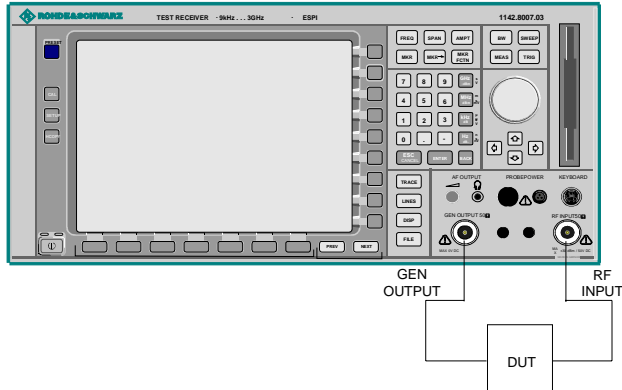
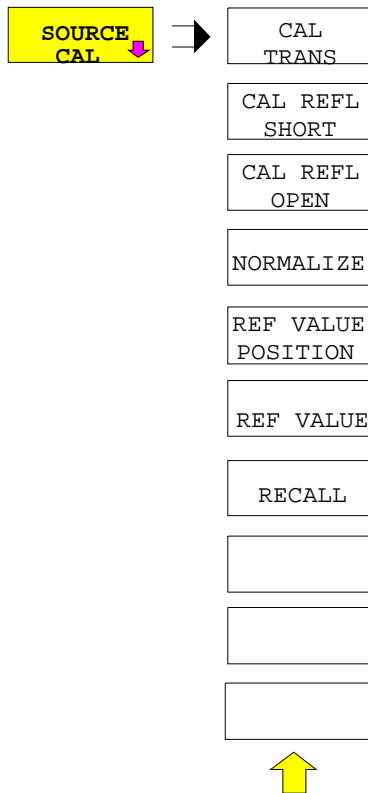

Fig. 4-25 Test setup for transmission measurement

A calibration can be carried out to compensate for the effects of the test setup (eg frequency response of connecting cables).

Calibration of Transmission Measurement

NETWORK menu:



The *SOURCE CAL* softkey opens a submenu comprising of the calibration functions for the transmission and reflection measurement.

The calibration of the reflection measurement (*CAL REFL...*) and its mechanisms are described in separate sections.

To carry out a calibration for transmission measurements the whole test setup is through-connected (THRU).

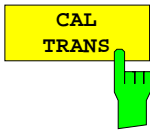

The *CAL TRANS* softkey triggers the calibration of the transmission measurement.

It starts a sweep that records a reference trace. This trace is then used to calculate the difference for the normalized values.

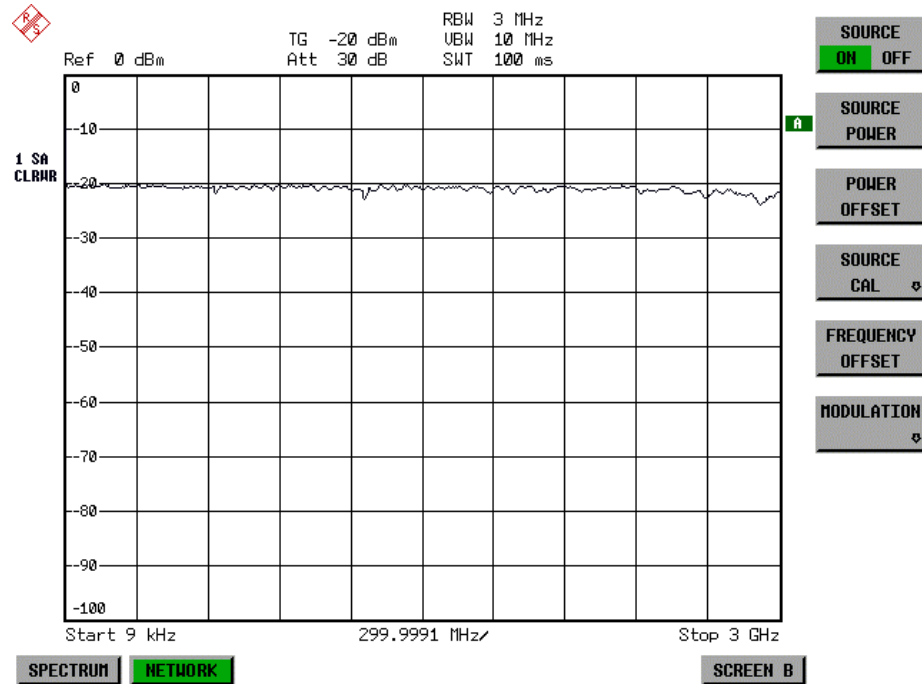
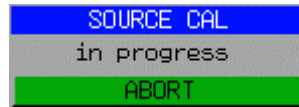
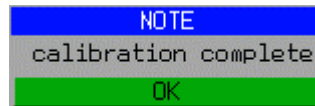

Fig. 4-26 Calibration curve for transmission measurement

During the calibration the following message is displayed:



After the calibration the following message is displayed:



This message will be cleared automatically after approx. 3 seconds.

IEC/IEEE-bus command: CORR:METH TRAN

Normalization

NETWORK-SOURCE CAL menu:

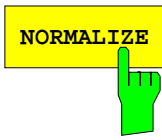

The *NORMALIZE* softkey switches the normalization on or off. The softkey is only available if the memory contains a correction trace.

It is possible to shift the relative reference point within the grid using the *REF VALUE POSITION* softkey. Thus, the trace can be shifted from the upper border of the grid to the vertical center of the grid:

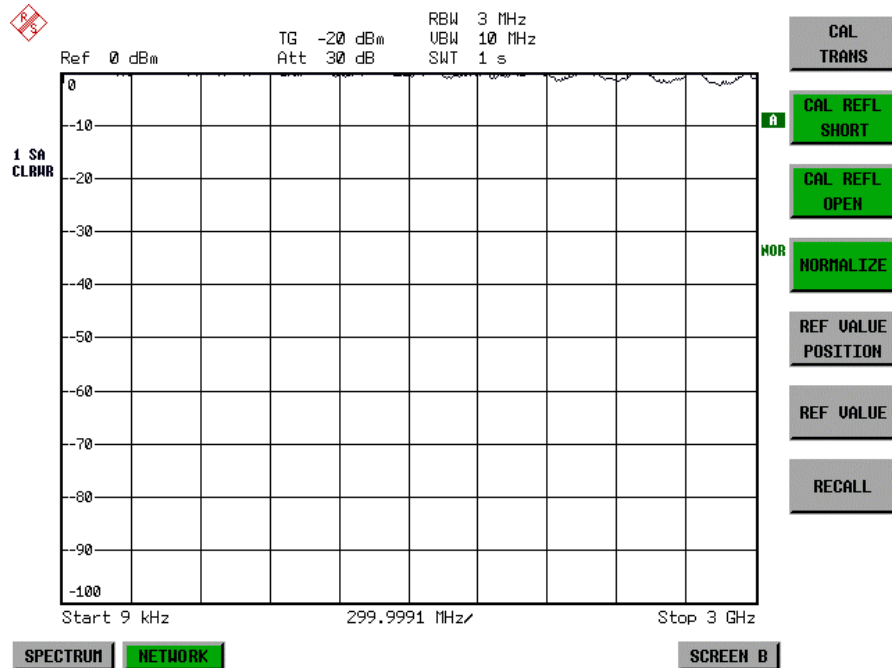

Fig. 4-27 Normalized display

In *SPLIT SCREEN* operation, the normalization is switched on in the currently active window. Different types of normalization can be active in the two windows.

Normalization is aborted when the *NETWORK* operating mode is quit.

IEC/IEEE-bus command: CORR ON



The *REF VALUE POSITION* softkey marks a reference position in the active window at which the normalization result (calculated difference with a reference trace) is displayed.

If no reference line is active, the softkey switches on a reference line and activates the input of its position. The line can be moved within the grid boundaries.

The reference line is switched off by pressing the softkey again.

The function of the reference line is explained in the section "Calibration mechanisms".

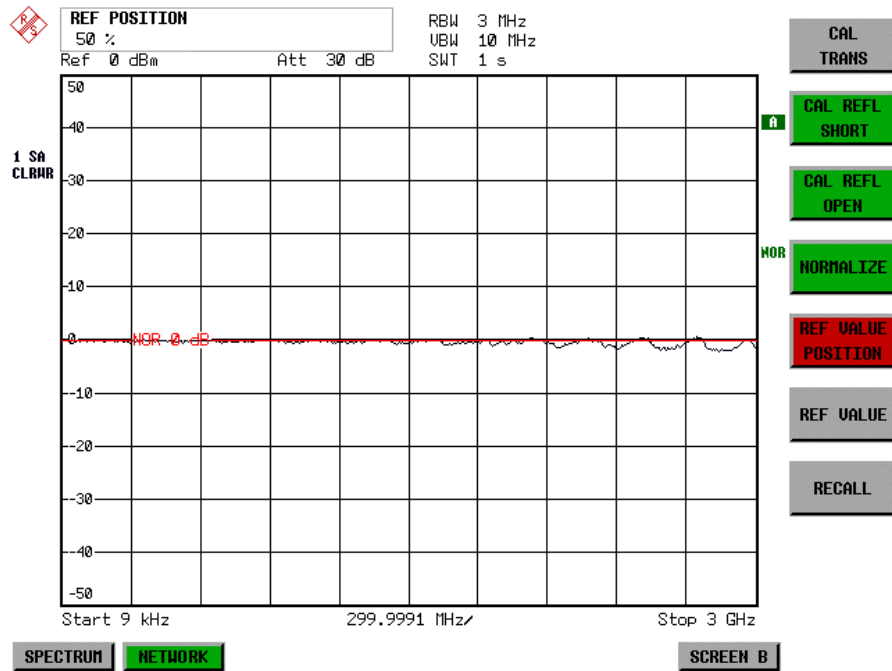
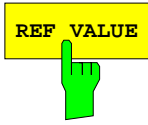

Fig. 4-28 Normalized measurement, shifted with *REF VALUE POSITION* 50 %

IEC/IEEE-bus command: DISP:WIND:TRAC:Y:RPOS 10PCT



The *REF VALUE* softkey activates the input of a value which is assigned to the reference line.

With default settings the reference line corresponds to a difference of 0 dB between the currently measured trace and the reference trace. Setting the *REF VALUE* to a different value helps to compensate for changes to the level conditions in the signal path after the calibration data have been recorded. If eg after a source calibration a 10 dB attenuation is inserted into the signal path between DUT and ESCI input, the measurement trace will be moved by 10 dB down. Entering a *REF VALUE* of -10 dB will then result in the reference line for difference calculation being moved by 10 dB down as well. This means that the measured trace will be placed on it, as displayed in figure 4-20.

REF VALUE always refers to the active window.

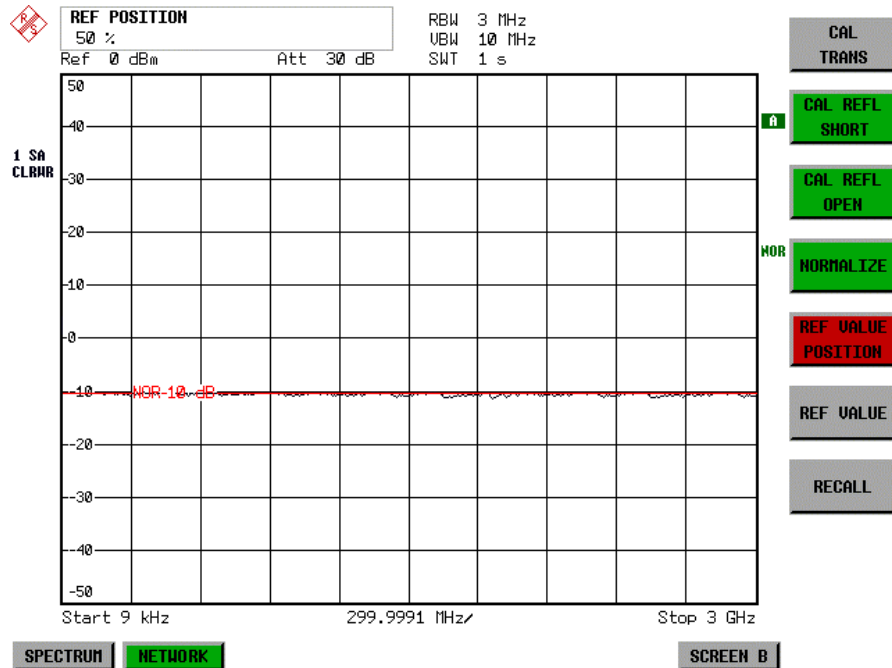

Fig. 4-29 Measurement with REF VALUE -10 dB and REF VALUE POSITION 50%

After the reference line has been moved by entering a *REF VALUE* of -10 dB the deviation from the nominal power level can be displayed with high resolution (eg 1 dB/div). The power is still displayed in absolute values, which means that in the above example 1 dB below the nominal power (reference line) = 11 dB attenuation.

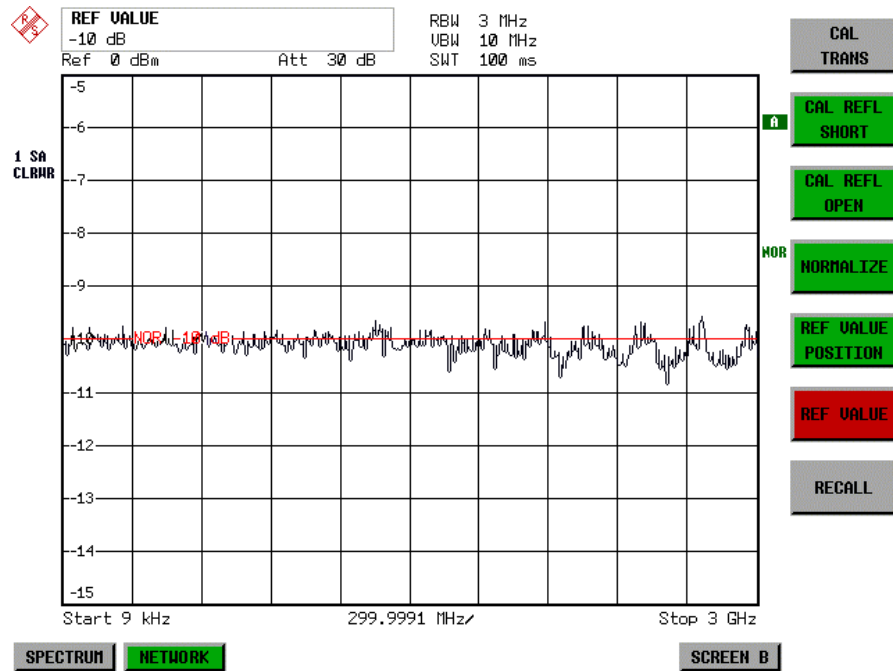
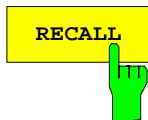

Fig. 4-30 Measurement of a 10dB attenuator pad with 1dB/DIV

IEC/IEEE-bus command: `DISP:WIND:TRAC:Y:RVAL -10dB`



The *RECALL* softkey restores the ESCI settings that were used during source calibration.

This can be useful if device settings were changed after calibration (eg center frequency, frequency deviation, reference level, etc).

The softkey is only available if:

- the NETWORK mode has been selected
- the memory contains a calibration dataset.

IEC/IEEE-bus command: `CORR:REC`

Reflection Measurement

Scalar reflection measurements can be carried out by means of a reflection-coefficient measurement bridge.

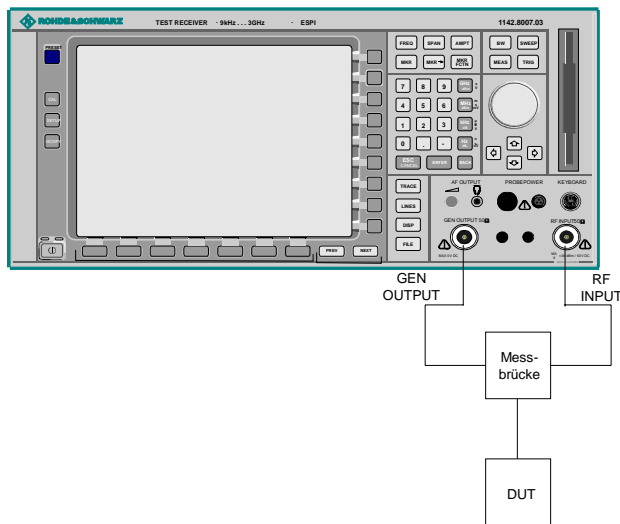
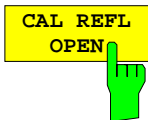

Fig. 4-31 Test Setup for Reflection Measurement

Calibration of Reflection Measurement

The calibration mechanism for reflection measurement is basically the same as the one used for transmission measurement.

NETWORK-SOURCE CAL submenu



The *CAL REFL OPEN* softkey starts the open-circuit calibration. During calibration the following message is displayed:

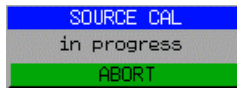

IEC/IEEE-bus command: `CORR:METH REFL`
`CORR:COLL OPEN`



The *CAL REFL SHORT* softkey starts the short-circuit calibration.

If both calibrations (open circuit, short circuit) are carried out, the calibration curve is calculated by averaging the two measurements and stored in the memory. The order of the two calibration measurements is free.

After the calibration the following message is displayed:

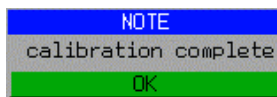

The message is cleared after approx. 3 seconds.

IEC/IEEE-bus command: `CORR:METH REFL`

Calibration mechanism

Calibration means a calculation of the difference between the currently measured power and a reference curve, independent of the selected type of measurement (transmission/reflection). The hardware settings used for measuring the reference curve are included in the reference dataset.

Even with normalization switched on, the device settings can be changed in a wide area without stopping the normalization. This reduces the necessity to carry out a new normalization to a minimum.

For this purpose the reference dataset (trace with 501 measured values) is stored internally as a table of 501 points (frequency/level).

Differences in level settings between the reference curve and the current device settings are taken into account automatically. If the span is reduced, a linear interpolation of the intermediate values is applied. If the span increases, the values at the left or right border of the reference dataset are extrapolated to the current start or stop frequency, ie the reference dataset is extended by constant values.

An enhancement label is used to mark the different levels of measurement accuracy. This enhancement label is displayed at the right diagram border when normalization is switched on and a deviation from the reference setting occurs. Three accuracy levels are defined:

Table 4-1 Measurement accuracy levels

Accuracy	Enhancement label	Reason/Limitation
High	NOR	No difference between reference setting and measurement
Medium	APX (approximation)	Change of the following settings: <ul style="list-style-type: none"> • coupling (RBW, VBW, SWT) • reference level, RF attenuation • start or stop frequency • output level of tracking generator • frequency offset of tracking generator • detector (max. peak, min. peak, sample, etc.) Change of frequency: <ul style="list-style-type: none"> • max. 501 points within the set sweep limits (corresponds to a doubling of the span)
-	Aborted normalization	<ul style="list-style-type: none"> • more than 500 extrapolated points within the current sweep limits (in case of span doubling)

Note: At a reference level (REF LEVEL) of -10 dBm and at a tracking generator output level of the same value the R&S ESCI operates without overrange reserve, ie the R&S ESCI is in danger of being overloaded if a signal is applied whose amplitude is higher than the reference line. In this case, either the message "OVLD" for overload is displayed in the status line or the display range is exceeded (clipping of the trace at the upper diagram border = Overrange).

Overloading can be avoided as follows:

- Reducing the output level of the tracking generator (SOURCE POWER, NETWORK menu)
- Increasing the reference level (REF LEVEL, AMPT menu)

Frequency-Converting Measurements

For frequency-converting measurements (eg on converter units) the tracking generator is able to set a constant frequency offset between the output frequency of the tracking generator and the receive frequency of the R&S ESCI.

Up to an output frequency of 150 MHz the measurement can be carried out in both inverted and normal positions.

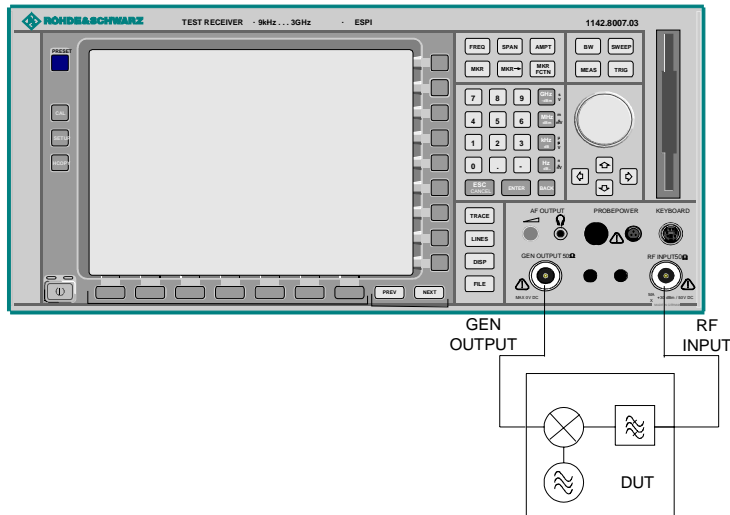
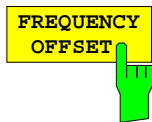

Fig. 4-32 Test setup for frequency converting measurements

NETWORK menu



The *FREQUENCY OFFSET* softkey activates the input of the frequency offset between the output signal of the tracking generator and the input frequency of the R&S ESCI. Possible offsets are in a range of ± 150 MHz in 0.1 Hz steps.

The default setting is 0 Hz. Offsets $\neq 0$ Hz are marked with the enhancement label **FRQ**.

If a positive frequency offset is entered, the tracking generator generates an output signal above the receive frequency of the R&S ESCI. In case of a negative frequency offset it generates a signal below the receive frequency of the R&S ESCI. The output frequency of the tracking generator is calculated as follows:

$$\text{Tracking generator frequency} = \text{receive frequency} + \text{frequency offset.}$$

IEC/IEEE-bus command: `SOUR:FREQ:OFFS 50MHz`

External Modulation of the Tracking Generator

NETWORK menu:

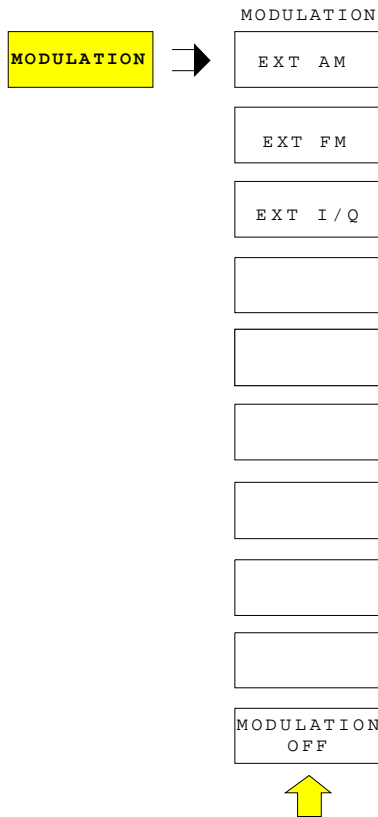

The *MODULATION* softkey opens a submenu for selecting different modulation modes.

The time characteristics of the tracking generator output signal can be influenced by means of external signals (input voltage range -1 V to +1 V).

Two BNC connectors at the rear panel are available as signal inputs. Their function changes depending on the selected modulation:

TG IN I / AM and
TG IN Q / FM

The modulation modes can be combined with each other and with the frequency offset function up to a certain degree. The following table shows which modulation modes are possible at the same time and which ones can be combined with the frequency offset function.

Table 4-2 Simultaneous modes of modulation (tracking generator)

Modulation	Frequency offset	EXT AM	EXT FM	EXT I/Q
Frequency offset		•	•	•
EXT AM	•		•	
EXT FM	•	•		
EXT I/Q	•			

• = can be combined

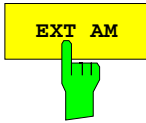

The *EXT AM* softkey activates an AM modulation of the tracking generator output signal.

The modulation signal is applied to the *TG IN I / AM* connector. An input voltage of 1 V corresponds to 100% amplitude modulation.

Switching on an external AM disables the following function:

- active I/Q modulation.

IEC/IEEE-bus command: `SOUR:AM:STAT ON`

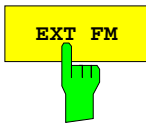

The *EXT FM* softkey activates the FM modulation of the tracking generator output signal.

The modulation frequency range is 1 kHz to 100 kHz, the deviation can be set in 1-decade steps in the range of 100 Hz to 10 MHz at an input voltage of 1 V. The phase deviation η should not exceed the value 100.

$$\text{Phase deviation } \eta = \text{deviation} / \text{modulation frequency}$$

The modulation signal is applied to the *TG IN Q / FM* connector.

Switching on an external FM disables the following function:

- active I/Q modulation.

IEC/IEEE-bus command: `SOUR:FM:STAT ON`
`SOUR:FM:DEV 10MHz`

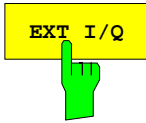

The *EXT I/Q* softkey activates the external I/Q modulation of the tracking generator.

The signals for modulation are applied to the two input connectors *TG IN I* and *TG IN Q* at the rear panel of the unit. The input voltage range is ± 1 V into 50 Ω .

Switching on an external I/Q modulation disables the following functions:

- active external AM
- active external FM

Functional description of the quadrature modulator:

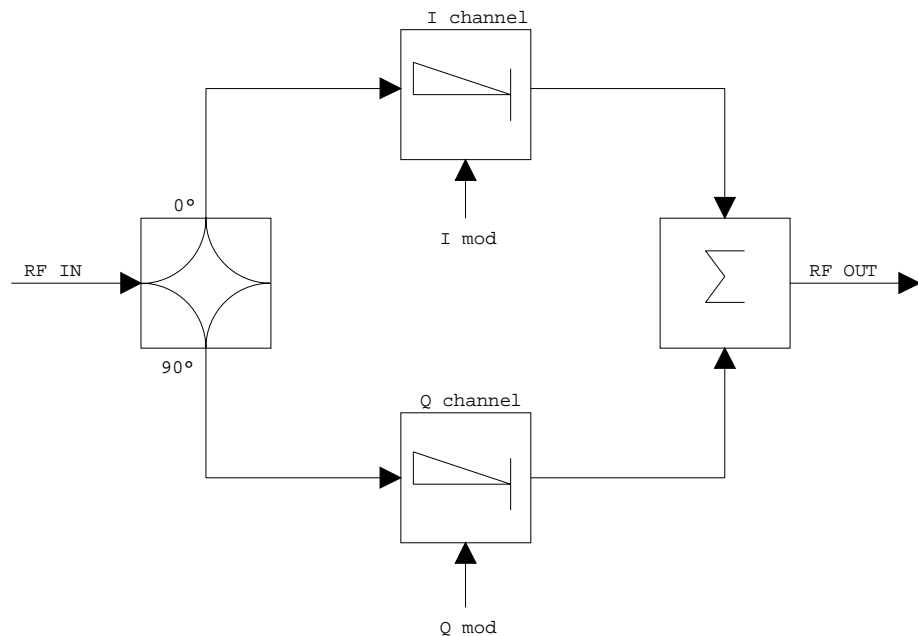
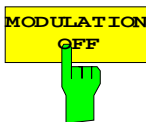

Fig. 4-33 I/Q modulation

I/Q modulation is performed by means of the built-in quadrature modulator. The RF signal is divided into two orthogonal I and Q components (inphase and quadrature phase). Amplitude and phase are controlled in each path by the I and Q modulation signal. By adding the two components an RF output signal is generated that can be controlled in amplitude and phase.

IEC/IEEE-bus command: `SOUR:DM:STAT ON`



The *MODULATION OFF* softkey switches off the modulation of the tracking generator.

IEC/IEEE-bus command: `SOUR:AM:STAT OFF`
`SOUR:FM:STAT OFF`
`SOUR:DM:STAT OFF`

Option External Generator Control - R&S FSP-B10

The external generator control option permits to operate a number of commercially available generators as tracking generator on the R&S ESCI. Thus, scalar network analysis with the R&S ESCI is also possible outside the frequency range of the internal tracking generator when the appropriate generators are used.

The R&S ESCI also permits to set a frequency offset for frequency-converting measurements when external generators are used. For harmonics measurements or frequency-converting measurements, it is also possible to enter a factor, by which the generator frequency is increased or reduced compared with the receive frequency of the R&S ESCI. Only make sure that the resulting generator frequencies do not exceed the allowed setting range of the generator.

The settable level range also depends on the generator used.

The generator is controlled via the – optional – second IECBUS interface of the R&S ESCI (= IEC2, supplied with the option) and, with some Rohde & Schwarz generators, additionally via the TTL synchronization interface included in the AUX interface of the R&S ESCI.

Note: *The use of the TTL interface enables considerably higher measurement rates as pure IECBUS control, because the frequency stepping of the R&S ESCI is directly coupled with the frequency stepping of the generator.*

Therefore, the frequency sweep differs according to the capabilities of the generator used:

- In the case of generators without TTL interface, the generator frequency is first set for each frequency point via IECBUS, then the setting procedure has to be completed before recording of measured values is possible.
- In the case of generators with TTL interface, a list of the frequencies to be set is entered into the generator before the beginning of the first sweep. Then the sweep is started and the next frequency point selected by means of the TTL handshake line TRIGGER. The recording of measured values is only enabled when the generator signals the end of the setting procedure via the BLANK signal. This method is considerably faster than pure IECBUS control.

With the "SELECT GENERATOR" softkey, a list of the supported generators with the frequency and level range as well as the capabilities used is included.

The external generator can be used in all operating modes. Recording of test setup calibration values (*SOURCE CAL*) and normalization with the correction values (*NORMALIZE*) are only possible in the *NETWORK* mode.

Note: *In order to enhance measurement accuracy a common reference frequency should be used for both the R&S ESCI and the generator. If no independent 10 MHz reference frequency is available, it is recommended to connect the reference output of the generator with the reference input of the R&S ESCI and to enable usage of the external Reference on the R&S ESCI via SETUP – REFERENCE EXT.*

Like the internal tracking generator, the external generator is activated by means of the *NETWORK* hotkey in the hotkey bar at the screen bottom:

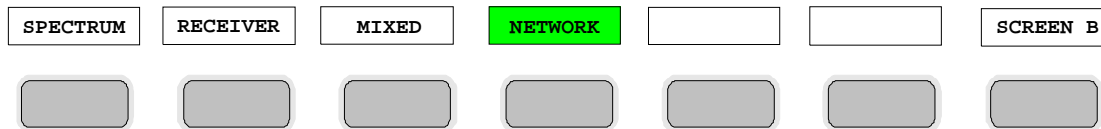

External Generator Settings

The *NETWORK* hotkey opens the menu for setting the functions of the external generator.

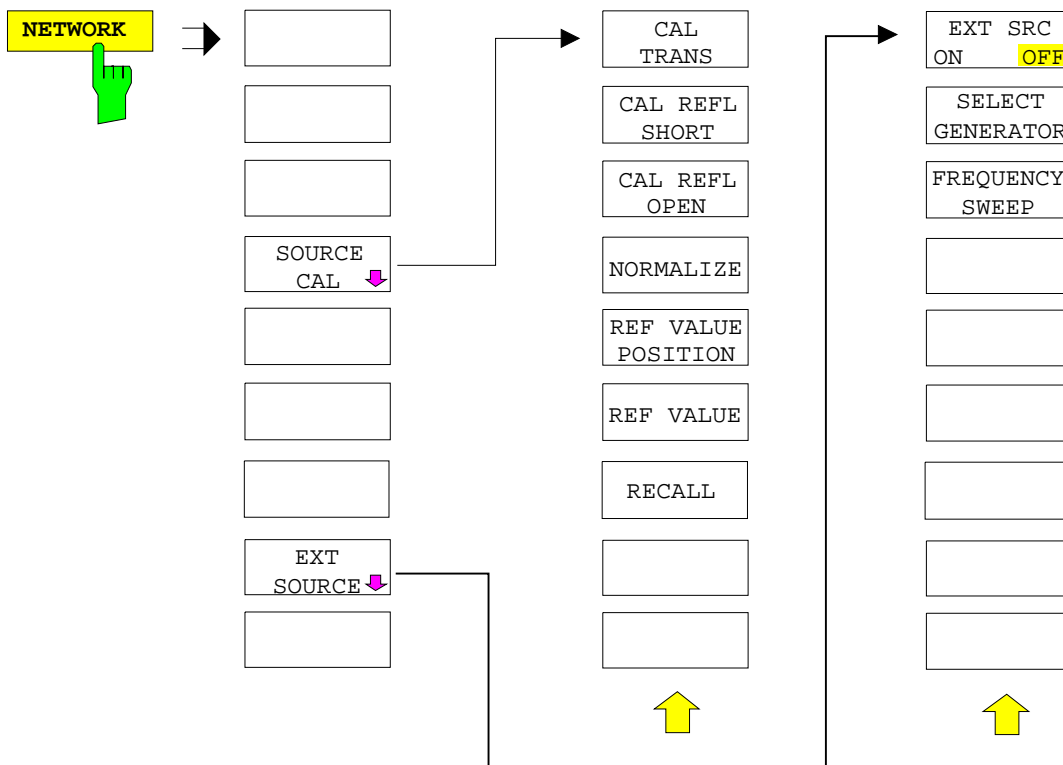

Note: Other softkeys are available in the displayed menus for controlling the internal tracking generator when option *Tracking Generator R&S FSP-B9* is fitted. For detailed information see section "*Option Tracking Generator R&S FSP-B9*".

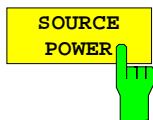

The *SOURCE POWER* softkey activates the entry of the generator output level. The value range depends on the selected generator (See table of chapter "Configuration of the External Generator").

Ist neben der Option *Externe Generatorsteuerung B10* auch die Option *Mitlaufgenerator B9* installiert, so verändert der Softkey wahlweise den Ausgangspegel des internen Mitlaufgenerators oder des externen Generators, je nachdem, welcher Generator gerade eingeschaltet ist.

Die Grundeinstellung des Ausgangspegels ist -20 dBm.

IEC/IEEE-bus command: `SOUR:EXT:POW -20dBm`

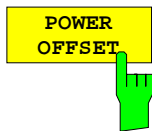

The *POWER OFFSET* softkey activates the entry of a constant level offset of the generator. With this offset, attenuator pads or amplifiers connected to the output connector of the generator can be handled during the input and output of output levels.

The permissible setting range is -200 dB to +200 dB in steps of 0.1 dB. Positive offsets handle a subsequent amplifier and negative offsets an attenuator pad.

The default setting is 0 dB; offsets \neq 0 are marked by the activated enhancement label **LVL**.

IEC/IEEE-bus command SOUR:POW:OFFS -10dB

Transmission Measurement

The transmission characteristic of a two-port network is measured. The external generator serves as a signal source. It is connected to the input connector of the DUT. The input of the analyser is fed from the output of the DUT.

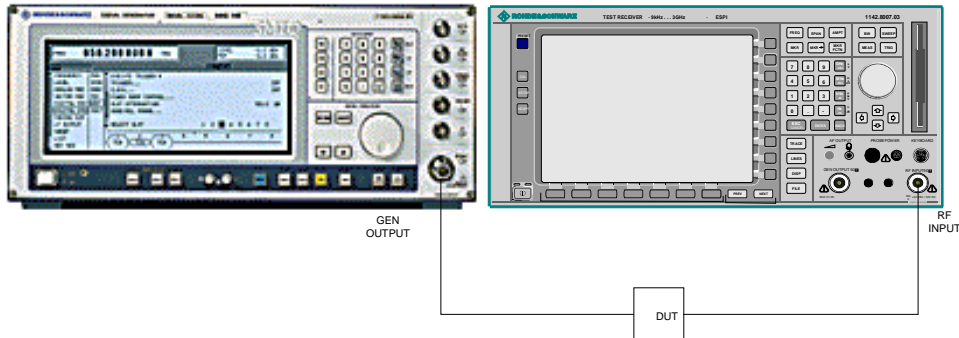
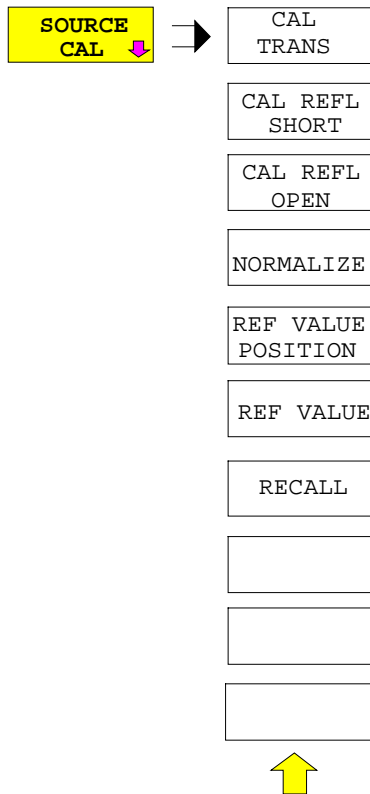

Fig. 4-34 Test setup for transmission measurement

A calibration can be carried out to compensate for the effects of the test setup (e.g. frequency response of connecting cables).

Calibration of Transmission Measurement

NETWORK menu:



The *SOURCE CAL* softkey opens a submenu comprising the calibration functions for the transmission and reflection measurement.

The calibration of the reflection measurement (*CAL REFL...*) and its functioning are described in separate sections.

To carry out a calibration for transmission measurements the whole test setup is through-connected (THRU).

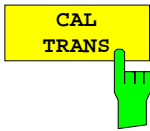

The *CAL TRANS* softkey triggers the calibration of the transmission measurement.

It starts a sweep that records a reference trace. This trace is then used to obtain the differences to the normalized values.

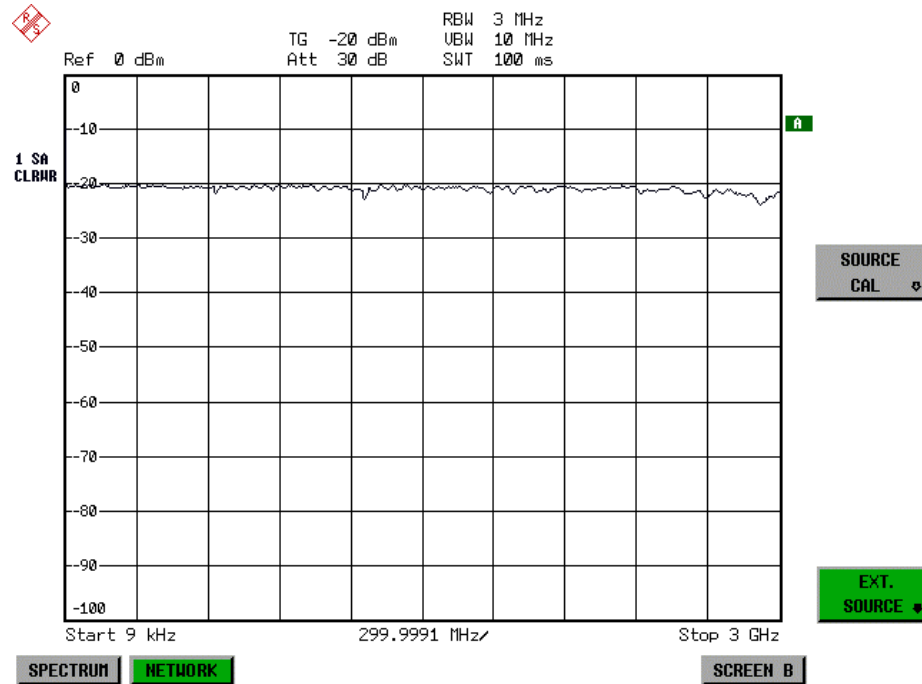
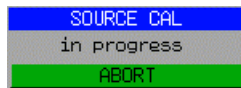
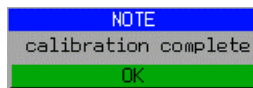

Fig. 4-35 Calibration curve for transmission measurement

During the calibration the following message is displayed:



After the calibration sweep the following message is displayed:



This message is cleared after approx. 3 seconds.

IEC/IEEE-bus command CORR:METH TRAN

Normalization:

NETWORK -SOURCE CAL menu:

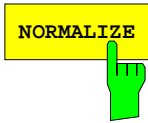

The *NORMALIZE* softkey switches normalization on or off. The softkey is only available if the memory contains a correction trace.

It is possible to shift the relative reference point within the grid using the *REF VALUE POSITION* softkey. Thus, the trace can be shifted from the top grid margin to the middle of the grid:

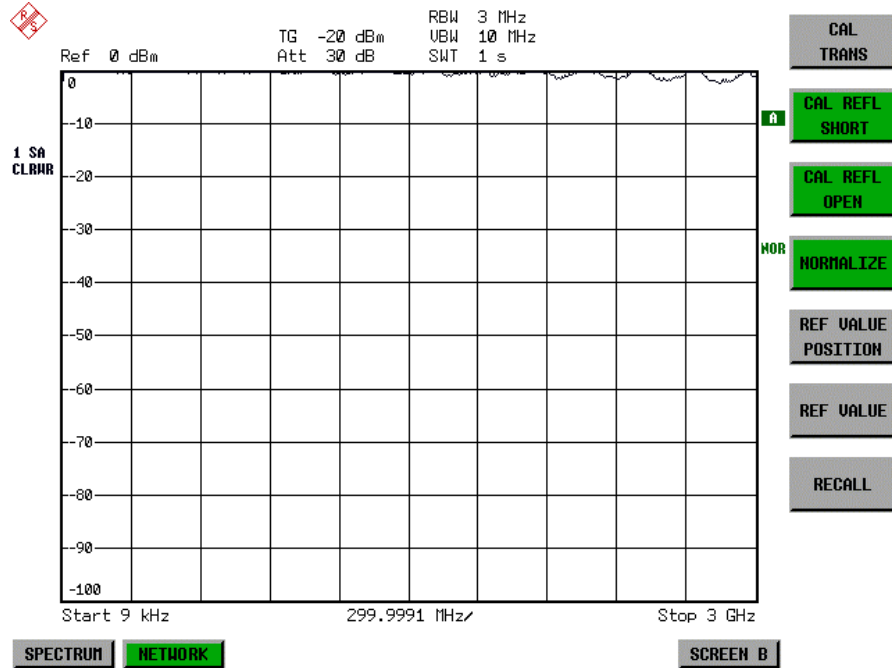
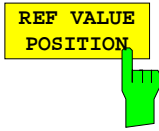

Fig. 4-36 Normalized display

In the *SPLIT SCREEN* setting, the normalization is switched on in the current window. Different normalizations can be active in the two windows.

Normalization is aborted when the *NETWORK* mode is quit.

IEC/IEEE-bus command: CORR ON



The *REF VALUE POSITION* softkey (reference position) marks a reference position in the active window on which the normalization (difference formation with a reference curve) is performed.

When pressed for the first time, the softkey switches on the reference line and activates the input of its position. The line can be shifted within the grid limits.

The reference line is switched off by pressing the softkey again.

The function of the reference line is explained in the section "Functioning of Calibration".

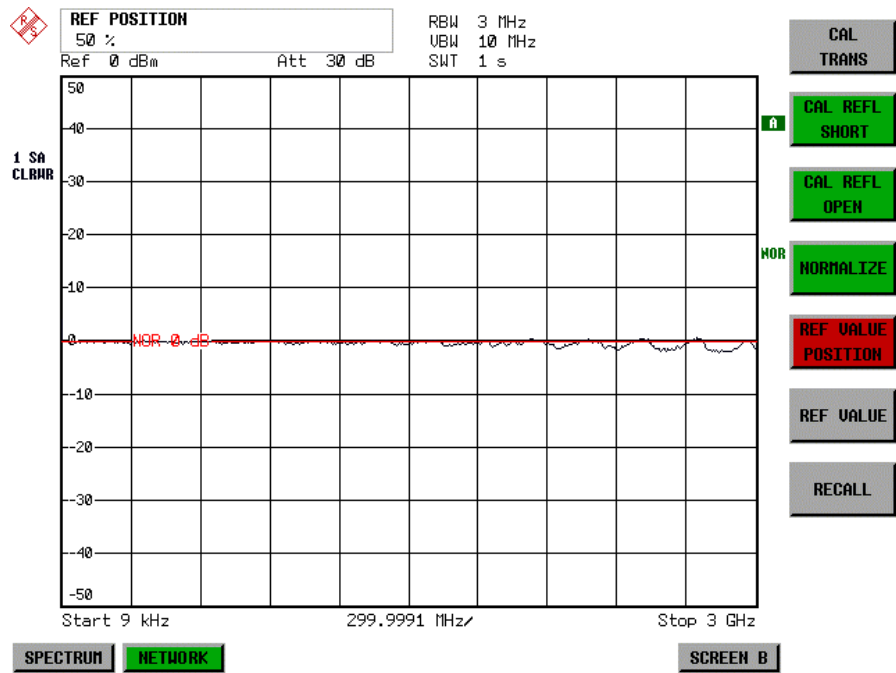
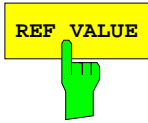

Fig. 4-37 Normalized measurement, shifted with *REF VALUE POSITION* 50 %

IEC/IEEE-bus command

DISP:WIND:TRAC:Y:RPOS 10PCT



The *REF VALUE* softkey activates the input of a level difference which is assigned to the reference line.

In the default setting, the reference line corresponds to a level difference of 0 dB. If e.g. a 10-dB attenuator pad is inserted between DUT and analyzer input between recording of the calibration data and normalization, the trace will be shifted down by 10 dB. By entering a *REF VALUE* of -10 dB the reference line for difference formation can also be shifted down by 10 dB so that it will again coincide with the trace (see Fig. 4.22-5).

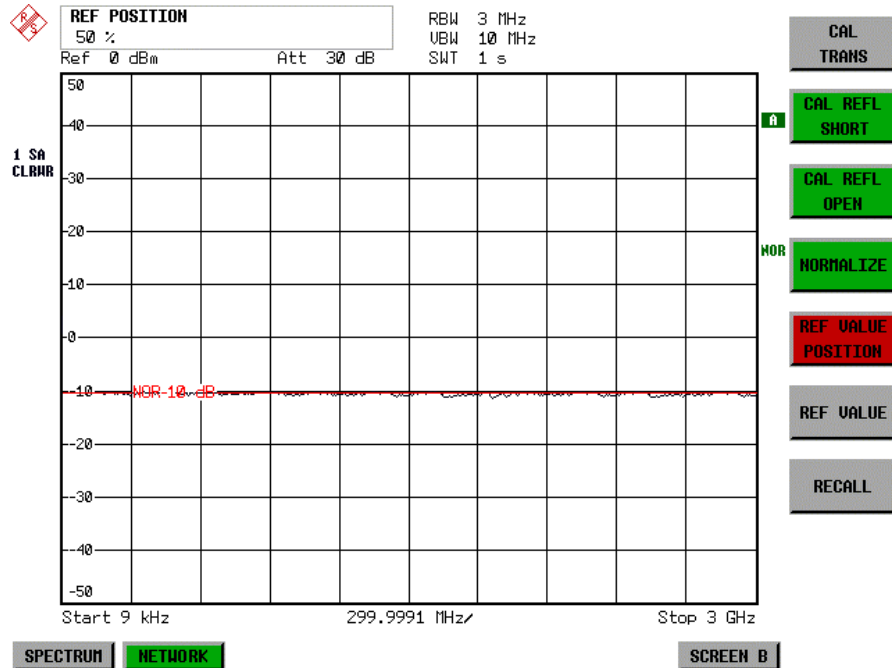

Fig. 4-38 Measurement with REF VALUE -10dB and REF VALUE POSITION 50%

After the reference line has been shifted by entering *REF VALUE* -10 dB, departures from the nominal value can be displayed with high resolution (e.g. 1 dB / Div.). The absolute measured values are still displayed, in the above example, 1 dB below nominal value (reference line) = 11 dB attenuation.

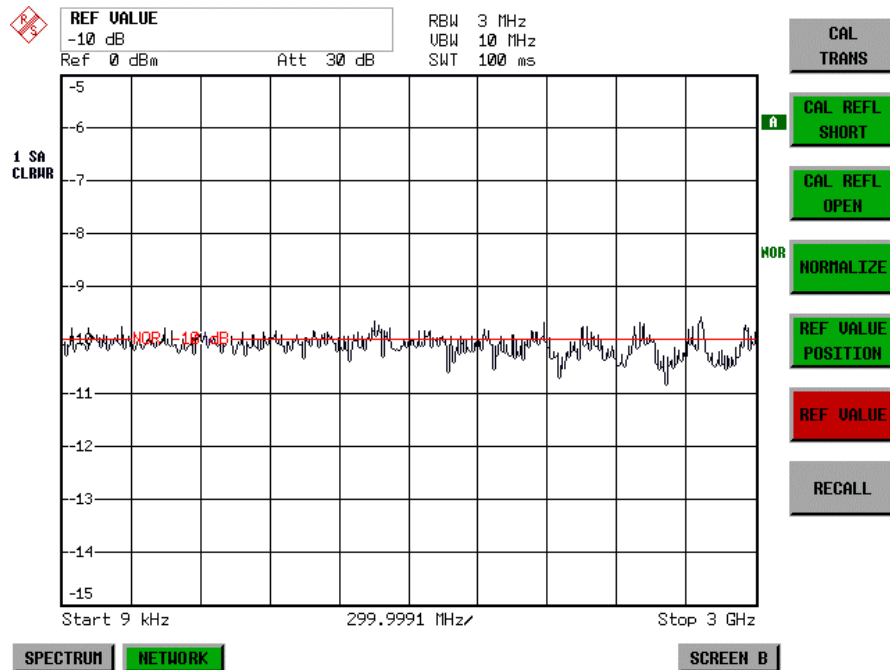
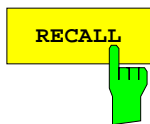

Fig. 4-39 Measurement of a 10-dB attenuator pad with 1dB/DIV

IEC/IEEE-bus command `DISP:WIND:TRAC:Y:RVAL -10dB`



The *RECALL* softkey restores the instrument setting with which the calibration was carried out. This can be useful if the device setting was changed after calibration (e.g. center frequency setting, frequency deviation, reference level, etc).

The softkey is only available if:

- the *NETWORK* mode has been selected
- the memory contains a calibration data set.

IEC/IEEE-bus command `CORR:REC`

Reflection Measurement

Scalar reflection measurements can be carried out by means of a reflection-coefficient bridge.

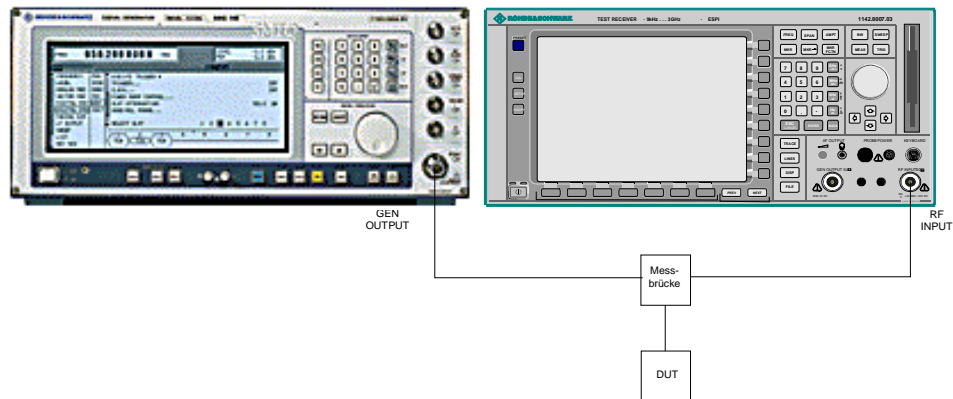

Fig. 4-40 Test setup for reflection measurement

Calibration of Reflection Measurement

The calibration mechanism essentially corresponds to that of the transmission measurement.

NETWORK-SOURCE CAL submenu



The *CAL REFL OPEN* softkey starts the open-circuit calibration. During calibration the following message is displayed:



IEC/IEEE-bus command CORR:METH REFL
 CORR:COLL OPEN



The *CAL REFL SHORT* softkey starts the short-circuit calibration.

If both calibrations (open circuit, short circuit) are carried out, the calibration curve is formed by averaging the two measurements and stored in the memory. The order of measurements is optional.

After the calibration the following message is displayed:

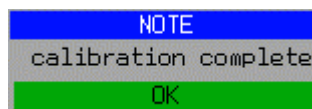

The display is cleared after approx. 3 seconds.

IEC/IEEE-bus command CORR:METH REFL
 CORR:COLL THR

Calibration mechanism

Calibration means a calculation of the difference between the currently measured power and a reference curve, independent of the selected type of measurement (transmission/reflection). The hardware settings used for measuring the reference curve are included in the reference dataset.

Even with normalization switched on, the device settings can be changed in a wide area without stopping the normalization. This reduces the necessity to carry out a new normalization to a minimum.

For this purpose, the reference dataset (trace with 501 measured values) is stored as a table with 501 points (frequency/level).

Differences in level settings between the reference curve and the current device settings are taken into account automatically. If the span is reduced, a linear interpolation of the intermediate values is applied. If the span increases, the values at the left or right border of the reference dataset are extrapolated to the current start or stop frequency, i.e. the reference dataset is extended by constant values.

An enhancement label is used to mark the different levels of measurement accuracy. This enhancement label is displayed at the right diagram border when normalization is switched on and a deviation from the reference setting occurs. Three accuracy levels are defined:

Table 4-5 Measurement accuracy levels

Accuracy	Enhancement label	Reason/Limitation
High	NOR	No difference between reference setting and measurement
Medium	APX (approximation)	Change of the following settings: <ul style="list-style-type: none"> • coupling (RBW, VBW, SWT) • reference level, RF attenuation • start or stop frequency • output level of tracking generator • frequency offset of tracking generator • detector (max. peak, min. peak, sample, etc.) Change of frequency: <ul style="list-style-type: none"> • max. 501 points within the set sweep limits (corresponds to a doubling of the span)
-	Aborted normalization	<ul style="list-style-type: none"> • more than 500 extrapolated points within the current sweep limits (in case of span doubling)

Note: *At a reference level (REF LEVEL) of -10 dBm and at a tracking generator output level of the same value the analyzer operates without overrange reserve, i.e. the analyzer is in danger of being overloaded if a signal is applied whose amplitude is higher than the reference line. In this case, either the message "OVLD" for overload is displayed in the status line or the display range is exceeded (clipping of the trace at the upper diagram border = Overrange).*

Overloading can be avoided as follows:

- *Reducing the output level of the tracking generator (SOURCE POWER, NETWORK menu)*
- *Increasing the reference level (REF LEVEL, AMPT menu)*

Frequency-converting Measurements

For frequency-converting measurements (e.g. on converters) the external generator is able to set a constant frequency offset between the output frequency of the generator and the receive frequency of the analyzer. In addition, the generator frequency as a multiple of the analyzer.

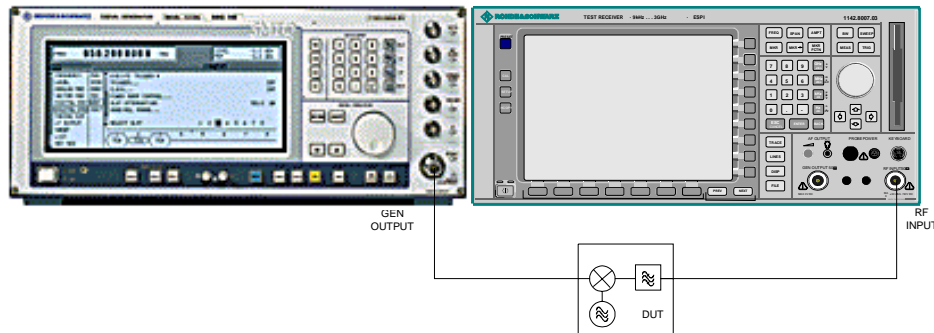
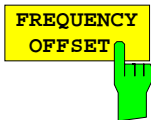

Fig. 4-41 Test setup for frequency-converting measurements

NETWORK Menu



The *FREQUENCY OFFSET* softkey activates the input of the frequency offset between the output signal of the generator and the input frequency of the analyzer. The value range depends on the selected generator. The default setting is 0 Hz. Offsets \neq 0 Hz are marked with the enhancement label **FRQ**.

If a positive frequency offset is entered, the tracking generator generates an output signal above the receive frequency of the analyzer. In case of a negative frequency offset it generates a signal below the receive frequency of the analyzer. The output frequency of the generator is calculated as follows:

$$\text{Generator frequency} = \text{receive frequency} + \text{frequency offset}$$

IEC/IEEE-bus command: SOUR:EXT:FREQ:OFFS 1GHZ

Configuration of an External Generator

NETWORK menu:

The screenshot shows the NETWORK menu with the following options on the left: EXT SOURCE (highlighted), EXT SRC ON/OFF, SELECT GENERATOR, FREQUENCY SWEEP, and several empty input fields. On the right, there are buttons for EXT SRC ON/OFF, SELECT GENERATOR, FREQUENCY SWEEP, and GEN REF INT/EXT. The main display area shows a table titled 'SELECT GENERATOR' and 'FREQUENCY SWEEP'.

SELECT GENERATOR							
SRC	TYPE	IFC	GPIO ADDR	MODE	F MIN	F MAX	P MIN P MAX
1	SINE03	TTL	28	REMOTE	5kHz	3GHz	-144dBm 16dBm
2	SNIQ03	GPIO	28	LOCAL	300kHz	3.3GHz	-140dBm 13dBm

FREQUENCY SWEEP						
SRC	STATE	POWER[dBm]	NUM	DEN	OFFSET	RESULT
1	<input checked="" type="checkbox"/>	-30dBm	1	1	0Hz	0Hz..3GHz *
2	<input type="checkbox"/>	-30dBm	1	1	0Hz	0Hz..3.2GHz

Additional display information includes: Ref -20 dBm, Att 10 dB, RBW 3 MHz, UBW 10 MHz, Start 0 Hz, 320 MHz, Stop 3.2 GHz, and buttons for SPECTRUM, NETWORK, and SCREEN B.

The *EXT SOURCE* softkey opens a submenu for configuration of the external generator.

The R&S ESCI is able to manage two generators, one of which can be active at the time.

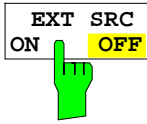

The *EXT SRC ON / OFF* softkey switches the external generator on or off. It can only be switched on successfully if the generator has been selected by means of *SELECT GENERATOR* and configured correctly by means of *FREQUENCY SWEEP*. If one of these conditions is not fulfilled, an error message will be output.

Notes: When switching on the external generator by means of *EXT SRC ON*, the R&S ESCI switches off the internal tracking generator and starts programming the generator settings via the IEC/IEEE-bus interface IEC2.

Programming requires takeover of the IEC/IEEE-bus control at this interface by the R&S ESCI. To avoid any access conflicts, ensure that no other controller is connected to the IEC2 interface or the external generator when selecting *EXT SRC ON*.

The maximum stop frequency is limited to the maximum generator frequency. This upper limit is automatically reduced by the set frequency offset of the generator and a set multiplication factor.

With the external generator switched on, the FFT filters (*FILTER TYPE FFT* in the menu *BW*) are not available.

If an error occurs on the IEC/IEEE bus when programming the external generator, the generator will automatically be switched off and the following error message will be output:



When the external generator is switched off using *EXT SRC OFF*, the IEC/IEEE-bus control is handed over again at the IEC2 interface, i.e. a different controller will then take over the control of the signal generator.

IEC/IEEE-bus command: SOUR:EXT ON

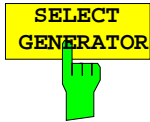

The *SELECT GENERATOR* softkey opens a table for selection of the generator and definition of IECBUS address and control interface. The table permits configuration of two generators so that switching between two different configurations is easily possible.

SELECT GENERATOR								
SRC	TYPE	IFC	GPIB ADDR	MODE	F MIN	F MAX	P MIN	P MAX
1	SME03	TTL	28	REMOTE	5kHz	3GHz	-144dBm	16dBm
2	SMIQ03	GPIB	28	LOCAL	300kHz	3.3GHz	-140dBm	13dBm

The individual fields contain the following settings:

SRC Index of generator selected

TYPE The field opens the list with the available generators:

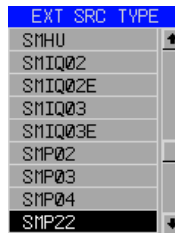

After completion of the selection, the remaining fields of the table are filled with the generator characteristics.

A list of generator types supported by the R&S ESCI is to be found at the end of section "Softkey *SELECT GENERATOR*".

IFC	<p>This field selects the interface type of external generator 1 or 2. The following types are available:</p> <p>GPIB IECBUS only, suitable for all generators of other manufacturers and some Rohde & Schwarz instruments</p> <p>or</p> <p>TTL IECBUS and TTL interface for synchronization, for most of the Rohde & Schwarz generators, see table above.</p> <p>The two operating modes differ in the speed of the control: Whereas, with pure IECBUS operation, each frequency to be set must be individually transferred to the generator, additional use of the TTL interface permits to program a total frequency list at once and subsequently perform the frequency stepping via TTL handshake, which is a big advantage in terms of speed.</p> <p>Note: <i>Generators equipped with the TTL interface can also be operated with IECBUS (= GPIB) only. Only one of the two generators can be operated with TTL interface at a time. The other generator must be configured for IECBUS (GPIB).</i></p>
GPIB ADDR	IECBUS address of the respective generator. Addresses from 0 to 30 are possible.
MODE	Operating mode of generator. The generator activated using the FREQUENCY SWEEP softkey is automatically set to remote mode (REMOTE), the other to manual mode (LOCAL).
F MIN F MAX	<p>Frequency range of generator. Select the start and stop frequency of the R&S ESCI in a way that the specified range is not exceeded.</p> <p>If the start frequency lies below F MIN, the generator is only switched on when F MIN is reached.</p> <p>If the stop frequency lies above F MAX, it is limited to F MAX when the generator is switched on using the EXT SRC ON/OFF softkey.</p>
P MIN P MAX	Level range of generator. This field defines the allowed input range for the POWER column in the FREQUENCY SWEEP table.
IEC/IEEE-bus commands	<pre> SYST:COMM:RDEV:GEN2:TYPE 'SME02' SYST:COMM:RDEV:GEN:LINK TTL SYST:COMM:GPIB:RDEV:GEN1:ADDR 28 </pre>

List of Generator Types Supported by the R&S ESCI

Generator	Interface Type	Generator Min Freq	Generator Max Freq	Generator Min Power dBm	Generator Max Power dBm
SME02	TTL	5 kHz	1.5 GHz	-144	+16
SME03	TTL	5 kHz	3.0 GHz	-144	+16
SME06	TTL	5 kHz	6.0 GHz	-144	+16
SMG	GPIB	100 kHz	1.0 GHz	-137	+13
SMGL	GPIB	9 kHz	1.0 GHz	-118	+30
SMGU	GPIB	100 kHz	2.16 GHz	-140	+13
SMH	GPIB	100 kHz	2.0 GHz	-140	+13
SMHU	GPIB	100 kHz	4.32 GHz	-140	+13
SMIQ02B	TTL	300 kHz	2.2 GHz	-144	+13
SMIQ02E	GPIB	300 kHz	2.2 GHz	-144	+13
SMIQ03B	TTL	300 kHz	3.3 GHz	-144	+13
SMIQ03E	GPIB	300 kHz	3.3 GHz	-144	+13
SMIQ04B	TTL	300 kHz	4.4 GHz	-144	+10
SMIQ06B	TTL	300 kHz	6.4 GHz	-144	+10
SML01	GPIB	9 kHz	1.1 GHz	-140	+13
SML02	GPIB	9 kHz	2.2 GHz	-140	+13
SML03	GPIB	9 kHz	3.3 GHz	-140	+13
SMR20	TTL	1 GHz	20 GHz	-130 ²⁾	+11 ²⁾
SMR20B11 ¹⁾	TTL	10 MHz	20 GHz	-130 ²⁾	+13 ²⁾
SMR27	TTL	1 GHz	27 GHz	-130 ²⁾	+11 ²⁾
SMR27B11 ¹⁾	TTL	10 MHz	27 GHz	-130 ²⁾	+12 ²⁾
SMR30	TTL	1 GHz	30 GHz	-130 ²⁾	+11 ²⁾
SMR30B11 ¹⁾	TTL	10 MHz	30 GHz	-130 ²⁾	+12 ²⁾
SMR40	TTL	1 GHz	40 GHz	-130 ²⁾	+9 ²⁾
SMR40B11 ¹⁾	TTL	10 MHz	40 GHz	-130 ²⁾	+12 ²⁾
SMR50	TTL	1 GHz	50 GHz	-130 ²⁾	+9 ²⁾
SMR50B11 ¹⁾	TTL	10 MHz	50 GHz	-130 ²⁾	+12 ²⁾
SMR60	TTL	1 GHz	60 GHz	-130 ²⁾	+9 ²⁾
SMR60B11 ¹⁾	TTL	10 MHz	60 GHz	-130 ²⁾	+12 ²⁾
SMP02	TTL	10 MHz	20 GHz	-130 ³⁾	+17 ³⁾
SMP03	TTL	10 MHz	27 GHz	-130 ³⁾	+13 ³⁾
SMP04	TTL	10 MHz	40 GHz	-130 ³⁾	+12 ³⁾
SMP22	TTL	10 MHz	20 GHz	-130 ³⁾	+20 ³⁾
SMT02	GPIB	5.0 kHz	1.5 GHz	-144	+13
SMT03	GPIB	5.0 kHz	3.0 GHz	-144	+13
SMT06	GPIB	5.0 kHz	6.0 GHz	-144	+13
SMV03	GPIB	9 kHz	3.3 GHz	-140	+13
SMX	GPIB	100 kHz	1.0 GHz	-137	+13
SMY01	GPIB	9 kHz	1.04 GHz	-140	+13
SMY02	GPIB	9 kHz	2.08 GHz	-140	+13
HP8340A	GPIB	10 MHz	26.5 GHz	-110	10
HP8648	GPIB	9 kHz	4 GHz	-136	10
HP ESG-A Series 1000A, 2000A, 3000A, 4000A	GPIB	250 kHz	4 GHz	-136	20
HP ESG-D SERIES E4432B	GPIB	250 kHz	3 GHz	-136	+10

1) Requires the option SMR-B11 to be fitted.

2) Maximum/minimum power depends on presence of Option SMR-B15/-B17 and set frequency range. For more details see SMR data sheet.

3) Maximum/minimum power depends on presence of Option SMP-B15/-B17 and set frequency range. For more details see SMP data sheet.

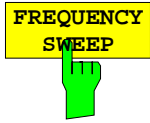

The *FREQUENCY SWEEP* softkey opens a table for setting the generator level as well as the multiplier and the offset used to derive the generator frequency from the analyzer frequency.

This table also permits configuration of two generators so that switching between two different configurations is easily possible.

FREQUENCY SWEEP						
SOURCE FREQ = REC FREQ * NUM/DEN + OFFSET						
SRC	STATE	POWER[dBm]	NUM	DEN	OFFSET	RESULT
1	✓	-30dBm	1	1	0Hz	0Hz..3GHz *
2		-30dBm	1	1	0Hz	0Hz..3.2GHz

- SRC Index of selected generator
- STATE Selects the active generator. Only one generator can be active at a time. The operating mode of the active generator is set to remote control in the *SELECT GENERATOR* table.
- POWER Permits to enter the generator level within the limits P MIN to P MAX of the *SELECT GENERATOR* table.
- NUM Numerator,
- DEN Denominator,
- OFFSET Offset, used to derive the generator frequency from the current frequency of the R&S ESCI according to the following formula:

$$F_{Generator} = F_{Analyzer} * \frac{Numerator}{Denominator} + F_{Offset}$$

Note that the frequencies resulting from start and stop frequency of the R&S ESCI do not exceed the allowed generator range:

- If the start frequency lies below F MIN, the generator is only switched on when F MIN is reached.
- If the stop frequency lies above F MAX, the generator is switched off. When the generator is subsequently switched on using the *EXT SRC ON/OFF* softkey, the stop frequency is limited to F MAX.
- If the stop frequency lies below F MIN, the generator is switched off and the following error message output:

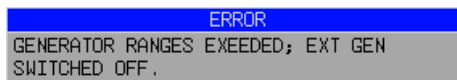

- In the time domain (Span = 0 Hz) the generator frequency is derived from the set receive frequency of the R&S ESCI using the calculation formula.

For the sake of clarity, the formula is also displayed in the table.

RESULT The frequency range of the generator resulting from the calculation formula. An asterisk (*) after the upper limit indicates that the stop frequency of the R&S ESCI must be adapted when the generator is switched on in order not to exceed its maximum frequency. In the following illustration, this is true for the upper generator at a stop frequency of 3.2 GHz of the R&S ESCI, whereas the lower generator does not yet require an adaptation:

SOURCE FREQ = REC FREQ * NUM/DEN + OFFSET			
NUM	DEN	OFFSET	RESULT
1	1	0Hz	0Hz..3GHz *
1	1	0Hz	0Hz..3.2GHz

IEC/IEEE-bus commands SOUR:EXT:POW -30dBm
 SOUR:EXT:FREQ:NUM 4
 SOUR:EXT:FREQ:DEN 3
 SOUR:EXT:FREQ:OFFS 100MHZ

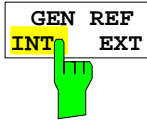

The *GEN REF INT / EXT* softkey switches over the reference oscillator of the generator (switchover between internal and external reference source). The internal reference source is selected as the default setting.

IEC/IEEE-bus command: SOUR:EXT1:ROSC INT

Option LAN Interface

Using option:FSP-B16 - LAN Interface, the instrument can be connected to an Ethernet LAN (Local Area Network). Thus it is possible to transfer data via the network and use network printers. In addition, the instrument can be remote-controlled via network. The network card allows both for a 10 MHz Ethernet IEEE 802.3 and a 100 MHz Ethernet IEEE 802.3u.

Connecting the Instrument to the Network



Caution:

Before connecting the instrument to the network it is recommended to contact the network administrator, in particular larger LAN installations are affected. Faults in the connection may have a negative effect on the entire network.

The instrument is connected to a network hub of the desired LAN segment via a commercially-available RJ45 cable (not supplied with the instrument) at the instrument rear panel. Since RJ45 provides no bus but a star network topology, no other precautions need to be taken for the connection.

The connection procedure does not produce any disturbances in the network traffic. Disconnection from the network is easily possible provided that there is no more data traffic from and to the instrument.

Installing the Software

The data transfer in the network takes place in data blocks, called packets. In addition to the useful data, further information on the operation, i.e. protocol data (transmitter, receiver, type of data, sequence), is transferred in the packets. For processing the protocol information, suitable drivers must be installed. For the network services (file transfer, directory services, printing in the network) a network operating system needs to be installed.

- Notes:**
- *The WINDOWS files required for the installation of network drivers, protocols or services are included in the directory "D:\V386".*
 - *A PC keyboard with trackball (or an additional mouse instead) is required for the installation.*

Installation of Drivers for the Network Card

.The network-card drivers do not have to be installed under Windows XP. It is sufficient to connect the network cable to the "LAN-Interface" connector at the rear of the unit. Windows XP will automatically recognize the network link and will activate the required drivers.

Note:

If the original factory setting is required at a later time, i.e. when the unit is to be operated with a different network configuration at a different site, this base configuration can be restored as described below:

- Switch the unit off and on again.
- In the Boot menu, select the entry "Analyzer Firmware Backup" with the cursor keys and confirm with *ENTER*. The device is started from the backup partition and opens a selection window with available device configurations:

```

* * * * *
* INSTRUMENT RESTORE PROCEDURE V 1.4      (c) RSD 2002
*
* Note:
* The presence of the LAN-interface requires
* a restore process different from the standard firmware
* restore (due to the necessary network drivers).
*
* The following 3 selections will NOT destroy user defined
* limit lines and transducer data
*
* Press 1   to perform standard system RESTORE
* press 2   to perform system RESTORE with LAN interface
* press 3   to ABORT system RESTORE
*
* The following selection will DESTROY user defined
* limit lines and transducer data
*
* Press 4   to perform standard system RESTORE
*           (destroys user limit lines and transducers !!!)
* press 5   to perform system RESTORE with LAN interface,
*           (destroys user limit lines and transducers !!!)
*
* * * * *

```

- Press 2. Windows XP is newly installed on the analyzer partition of the hard disk with LAN support and device firmware. The device may boot several times. At the end of the installation procedure, the device firmware will be restarted.

The unit is again ready for operation. The configuration of the network protocols then has to be performed according to the following sections.

Configuration of Available Network Protocols (TCP/IP Protocol)

When the unit is delivered, the TCP/IP network protocol is factory-set with the IP address 10.0.0.10 and the subnet mask 255.255.255.0. The steps required to change this configuration and to install further network protocols are described in this and the following sections.

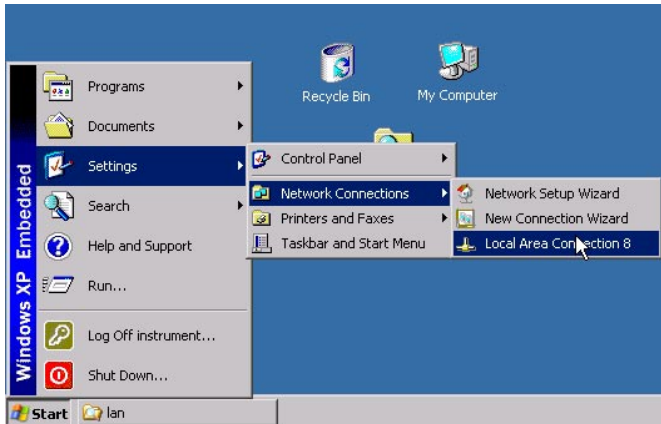

- Open the Windows XP start menu with the Windows key or *CTRL-ESC*.
- Click *Settings - Network Connections - Local Area Connection*.

The *Local Area Connection Status* dialog will be opened.

Note:

Windows XP appends numbers to the name *Local Area Connection Status* (e.g. *Local Area Connection Status 8*) if the configuration is created with the *New Connection Wizard*. These numbers are irrelevant for the following configurations and are therefore not mentioned in the text.

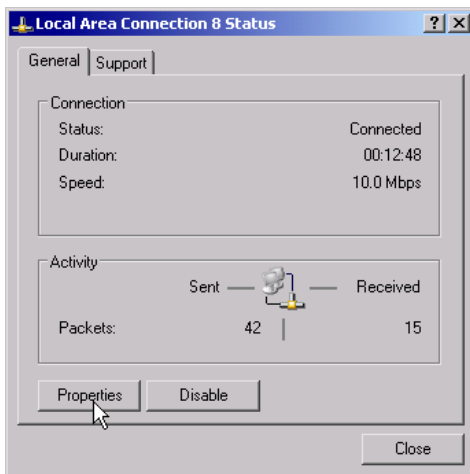

- Click the *Properties* button.
The window with the available network protocols will be opened.

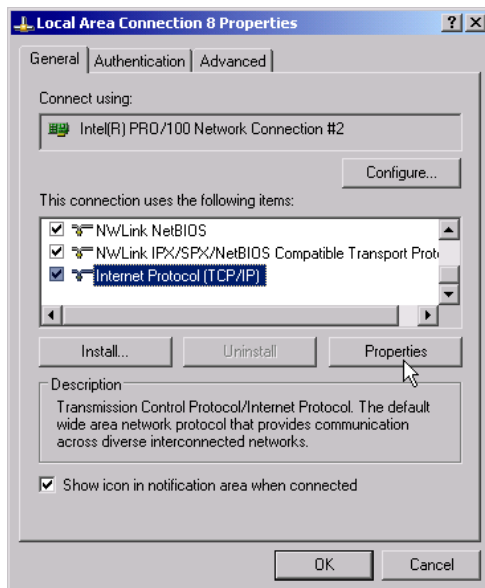

- Click the desired network protocol (in the example: TCP/IP).
- Click the *Properties* button.

The dialog with the settings of the selected network protocol will be opened.

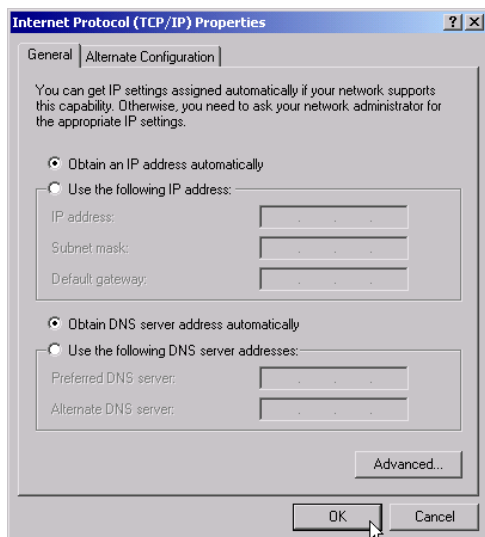

- If the IP address is to be automatically requested by a DHCP server, click the entry *Obtain an IP address automatically*.

Note:

Your network administrator knows whether your network has a DHCP server.

- Click the OK button. Windows will store the configuration.

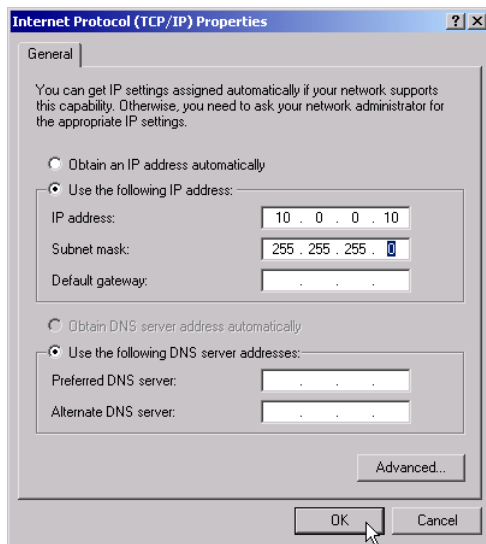

- If a predefined IP address is to be set (since no DHCP server is available in the network), click the entry *Use the following IP address*.
- Click the entry *IP address* and enter the IP address.
- Then click the entry *Subnet mask* and enter the required mask.

Note:

Your network administrator knows which IP addresses and subnet masks are suitable for your network.

- Click the OK button. Windows checks whether the entered settings are correct and stores the configuration.

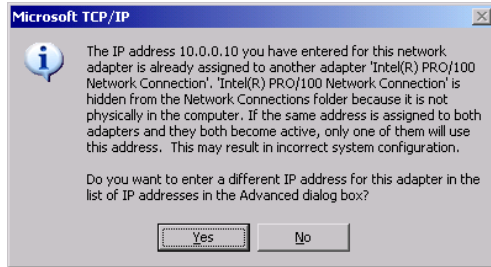

If an invalid IP address or subnet mask was entered, a corresponding error message will be displayed together with a question as whether a different address or mask is to be entered.

- Click the Yes button.
The dialog for entering the TCP/IP parameters will again be opened.

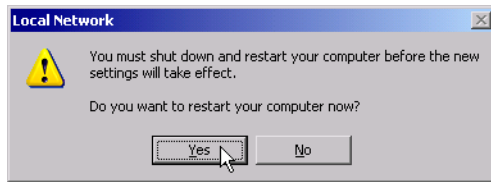

If all settings are correct, the request to start the unit again will be displayed depending on the changed settings.

- Click the Yes button.
Windows will restart the system.

Installation of Further Network Protocols and Services (e.g. Novell Netware Support)

Note: The network administrator knows the protocols to be used. The TCP/IP protocol has to be installed for the RSIB protocol and the VX11 support. The support for the Novell netware is additionally installed in the following example.

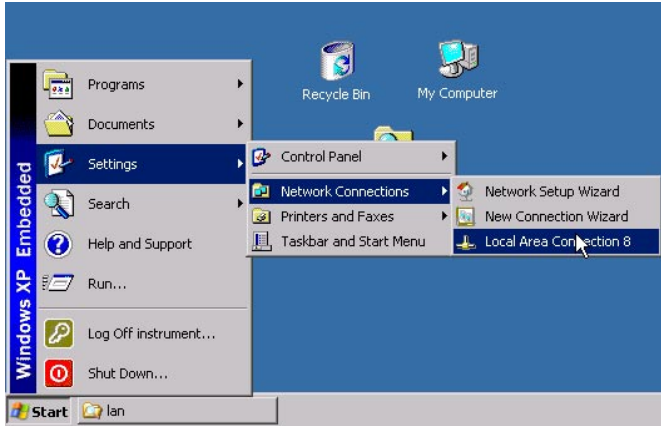

- Open the Windows XP start menu using the Windows key or *CTRL-ESC*.
- Click *Settings - Network Connections - Local Area Connection*.

The *Local Area Connection Status* dialog will be opened.

Note: Windows XP appends numbers to the name *Local Area Connection Status* (e.g. *Local Area Connection Status 8*) if the configuration is created with the *New Connection Wizard*. These numbers are irrelevant for the following configurations and are therefore not mentioned in the text.

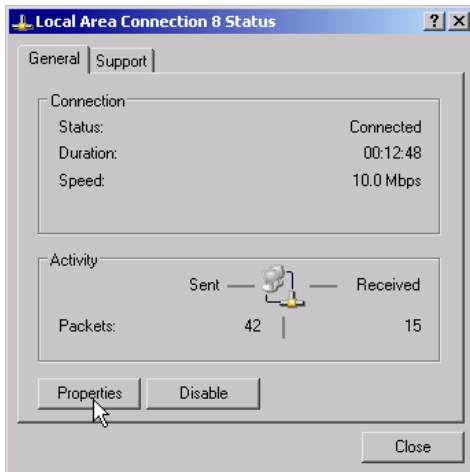

- Press the *Properties* button. The window with the available network protocols will be opened.

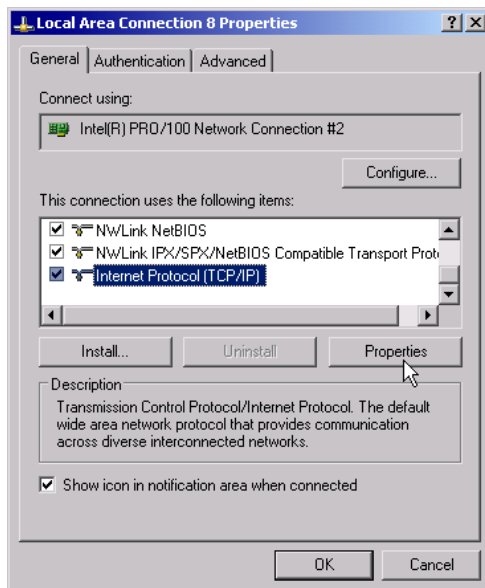

- Click the *Install* button.

The list of installable network components will be opened.

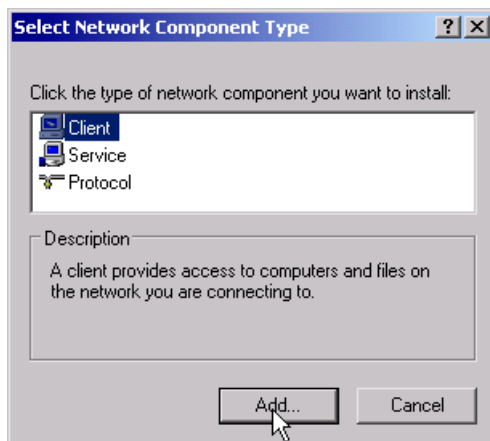

- Select *Client*.
- Click the *Add...* button.

The list of available network protocols will be opened.

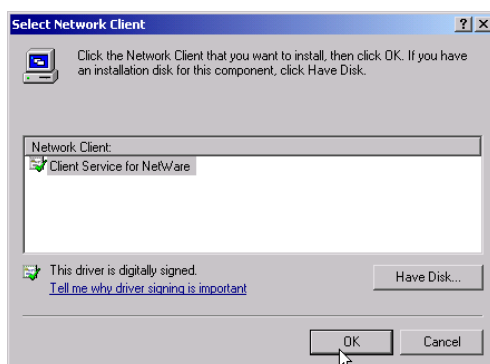

- Select *Client Service for NetWare*.
- Click the *OK* button.

The network driver for Novell Netware is installed.

Note:

- Your network administrator knows which clients, services and protocols have to be installed for your network.
- If network components not contained in D:\I386 are to be installed, a corresponding disk including the drivers has to be prepared (or a CD that can be read via a USB CD-ROM drive).

In this case, click the *Have Disk...* button and indicate the path with the corresponding drivers.

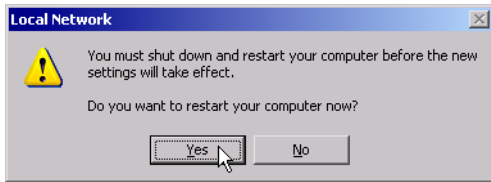

After completion of the installation, the user is requested to restart the unit.
 ➤ Click the Yes button.
 Windows will restart the system.

Examples of Configurations

Network	Protocols	Services	Notes
NOVELL Netware	NWLink IPX/SPX Compatible Transport	Client Service for NetWare	In folder "Protocols - Properties", the frame type used in the network is to be set.
IP Networks (FTP, TELNET, WWW, GOPHER, etc)	TCP/IP Protocol	Simple TCP/IP Services	In folder "Protocols - Properties", an IP address that is unique in the network is to be set.
MICROSOFT Network	NetBEUI Protocol or TCP/IP Protocol	Workstation Server	In folder "Identification - Computer Name", a name that is unique in the network is to be entered.

Subsequent Changing of the Network Configuration (Computer Name, Domain, Workgroup, etc)

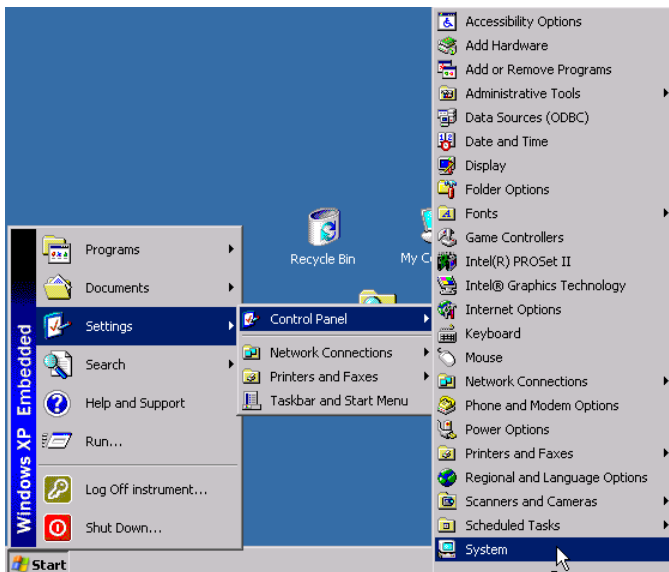

After completion of the installation, the computer name can be adapted as follows:

- Press the Windows key or <CTRL><ESC>.
- The Windows Start menu will be opened.
- Select Settings - Control Panel - System.

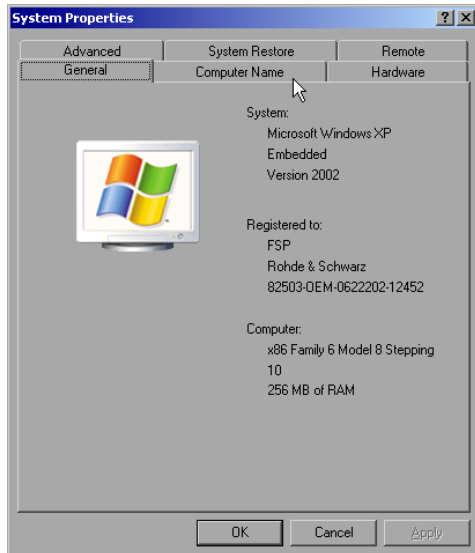

- Select the "Computer Name" tab.

Note:

The other settings can be changed after selection of the other tabs. It is strongly recommended to consult the network administrator beforehand.

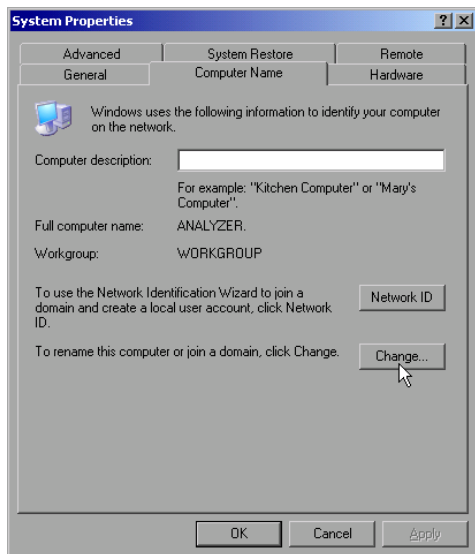

- Click the *Change* button.

The dialog to change the computer name, the domain and workgroup will be opened.

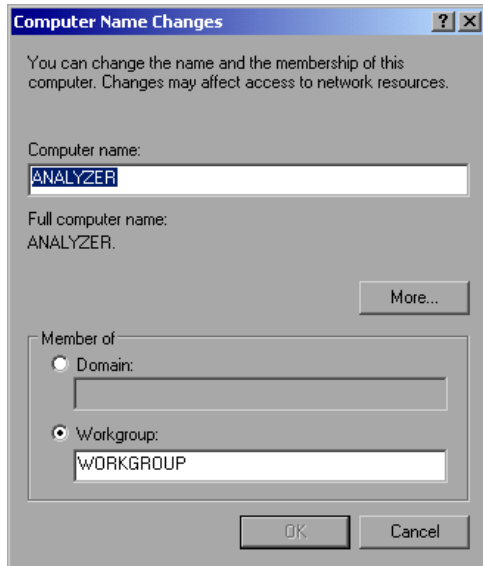

- Enter a new computer name.
- If required, enter the desired domain or workgroup.
- Confirm the changes with *OK*.

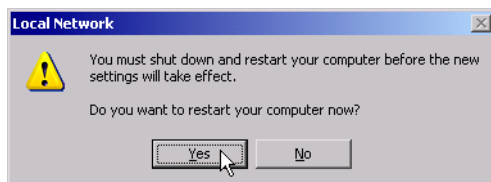

If the request to restart the unit is displayed:

- Click the *Yes* button.
Windows will restart the system.

Operating the Instrument without a Network

If the instrument is to be operated without any network connection for a limited or unlimited period of time, or permanently, no special precautions have to be taken in contrast to Windows NT. Windows XP automatically recognizes the interruption of the network connection and will not carry out any setup when the instrument is switched on.

If the user name and the password are not to be queried, proceed as described in section "Reenabling the Autologin Mechanism".

Operating the Instrument on the Network

After the network support has been installed, it is possible to exchange data between the instrument and other computers and to use printers in the network.

A prerequisite to network operation is having the appropriate access rights for the required network resources. Resources may be file directories of other computers or also central printers.

Access rights can be obtained from the network or server administrator. In that respect it is necessary to obtain the network name of the resource as well as the corresponding access rights.

To prevent misuse, the resources are protected by passwords. Normally, every entitled user of the resources is assigned a user name that is also protected by a password. Resources can then be assigned to this user. It is possible to determine the type of data access, i.e. whether data can only be read or also written, as well as shared data access. Depending on the network operating system, different types of usage are possible.

NOVELL Networks

The operating system NETWARE from NOVELL is a server-based system. Data cannot be exchanged between individual workstations; data transfer takes place between the PC and a server. This server provides memory space and the connection to network printers. On a server, data is organized in directories as under DOS and mapped to the workstation as virtual drives. A virtual drive behaves like an additional hard disk on the workstation, and the data can be edited accordingly. Network printers can also be addressed like normal printers.

There are two versions of the NOVELL network operating system: bindary-based (NETWARE 3) and NDS-based (more recent versions of NETWARE). With the older version (NETWARE 3), each server manages its resources on its own and is independent. A user must be managed on each server separately. In the case of NDS-based versions, all resources in the network are managed together in the NDS (NOVELL DIRECTORY SERVICE). The user must log into the network only once and is given access to the resources according to his/her access rights. The individual resources and users are managed as objects in a hierarchical tree (NDS TREE). The position of the object in the tree is referred to as "CONTEXT" with NETWARE and must be known for access to the resources.

MICROSOFT Network

In case of a MICROSOFT network, data can be exchanged both between workstations (peer to peer) and between workstations and servers. The latter can supply access to files and connection to the printers. On a server, data is organized in directories as under DOS and mapped to the workstation as virtual drives. A virtual drive behaves like an additional hard disk on the workstation, and the data can be edited accordingly. Network printers can also be addressed like normal printers. A connection is possible to DOS, WINDOWS FOR WORKGROUPS, WINDOWS95/98/ME, WINDOWS NT/XP.

Defining Users

After the network driver software has been installed, the instrument will output an error message on the next power-on, as there is no user called "Instrument" (= user name for XP autologin) in the network. It is therefore necessary to define a common user for Windows XP, to adapt the password to the network password and the network and to disable the autologin mechanism subsequently.

The definition of new users in the network is done by the network administrator. For definition of a new user on the instrument, the User Account Assistant is required:

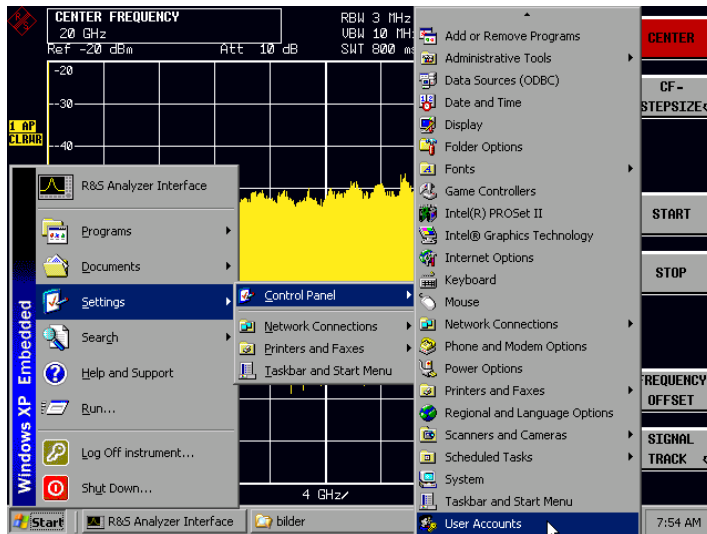

- Call up the Windows XP start menu using the Windows key or the key combination <CTRL> <ESC>.
- Then click "Settings", "Control Panel" and "User Accounts" one after the other.

The User Accounts wizard with the *Pick a task...* dialog will be opened.

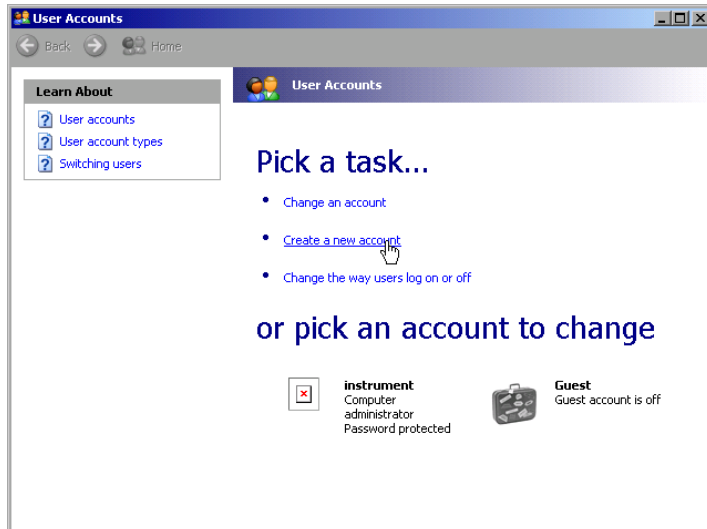

- Select "Create a new account" .

The dialog to enter a new user name will be opened.

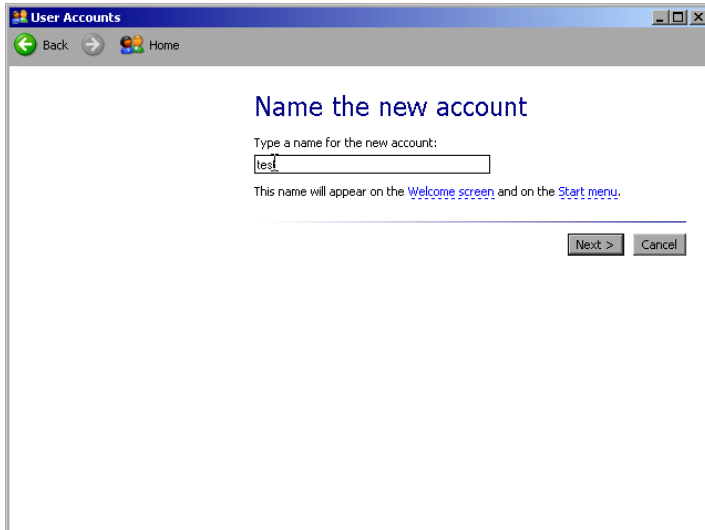

- Enter the name of the new user into the text field and terminate the entry with "Next ->".

The *Pick an account type* dialog to select the user rights will be opened.

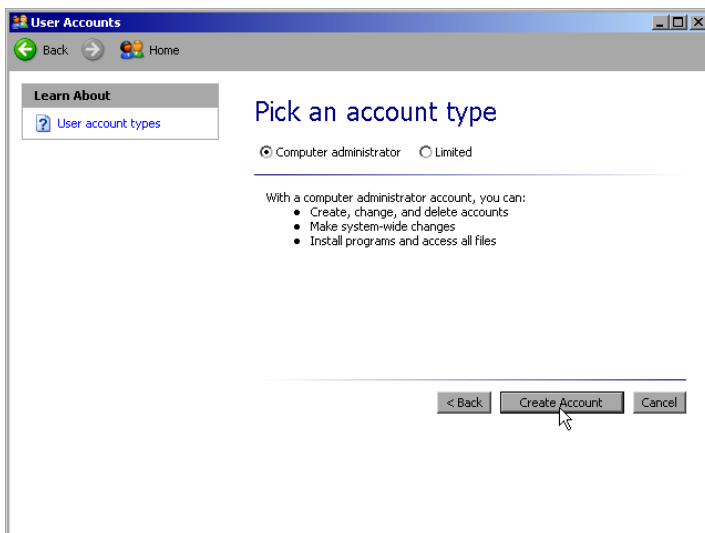

- Select *Computer administrator*.

Note:

Administrator rights are required to ensure trouble-free operation of the firmware.

- Confirm the newly created user with the *Create Account* button.

The new user is created.

Changing the User Password

After the new user has been created, the password has to be adapted to the network password. This is also done via the User Accounts wizard:

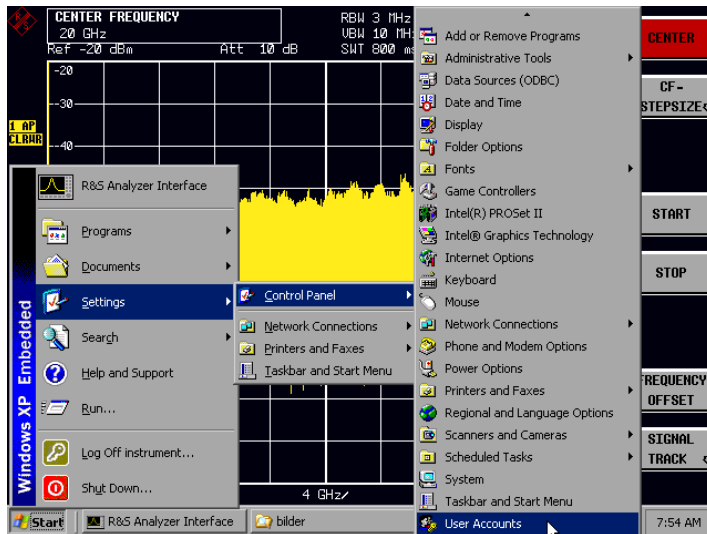

- Call up the Windows XP start menu using the Windows key or the key combination <CTRL> <ESC>.
- Then click "Settings", "Control Panel" and "User Accounts" one after the other.

The User Accounts wizard with the *Pick a task...* dialog will be opened.

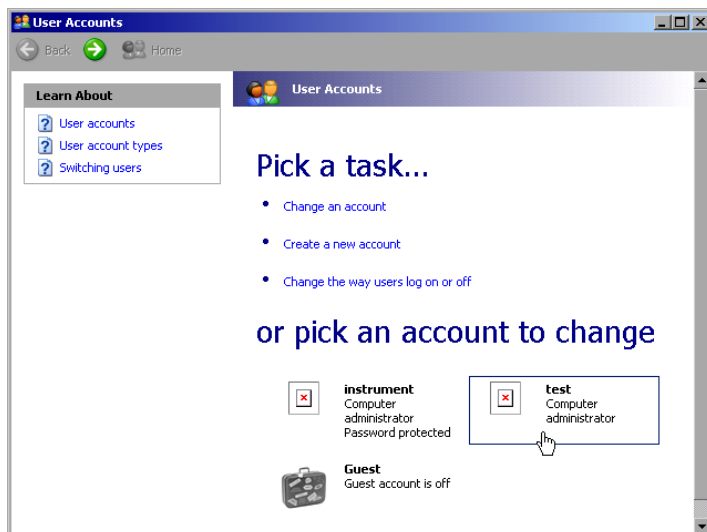

- Click the required user account (in the example: "test"). The dialog to select the desired action will be opened.

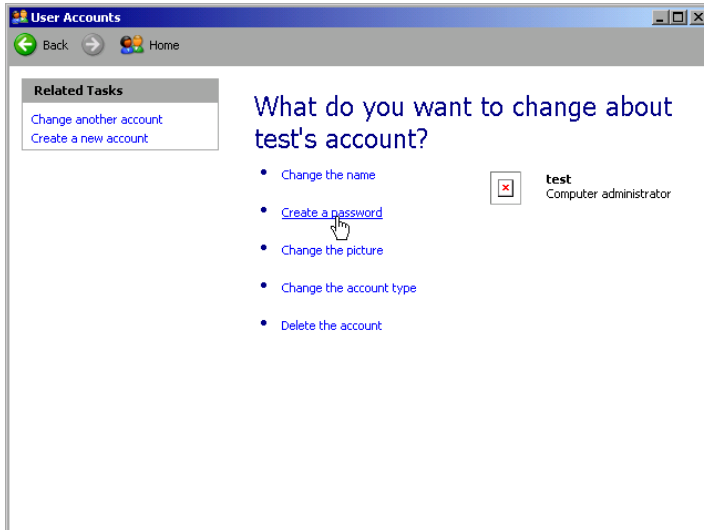

➤ Click *Create a password*.

The dialog to enter a new password will be opened.

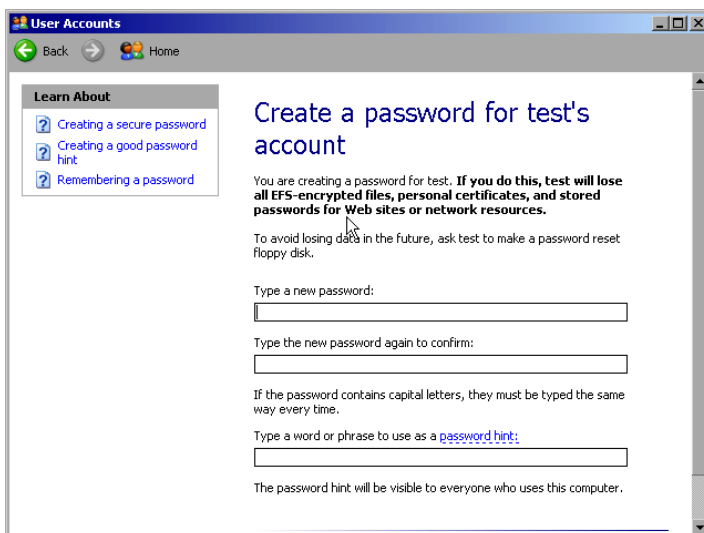

➤ Enter the new password in the upper text line and repeat the entry in the line below.

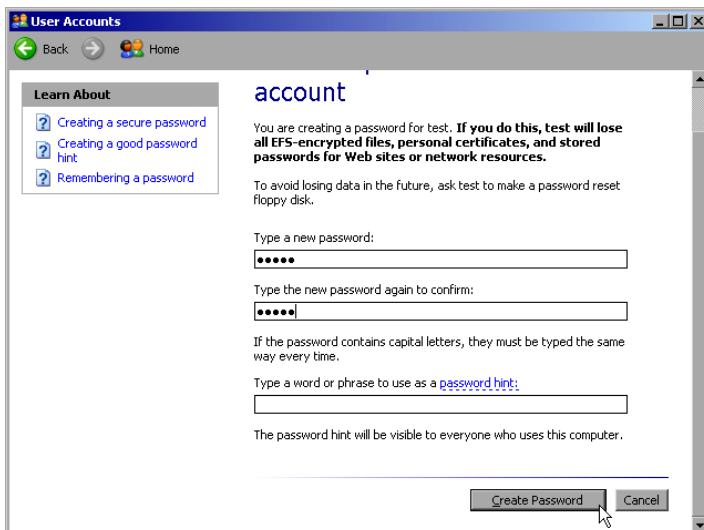

➤ Scroll the picture contents downwards and terminate the entry with the *Create Password* button.

The new password is activated.

NOVELL network only: Configure NOVELL client

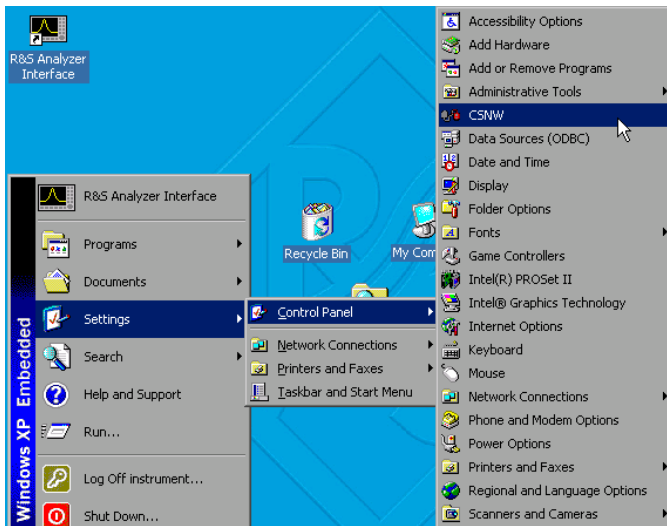

- Call up the Windows XP start menu using the Windows key or the key combination <CTRL> <ESC>.
- Then click "Settings", "Control Panel" and "CSNW" one after the other.

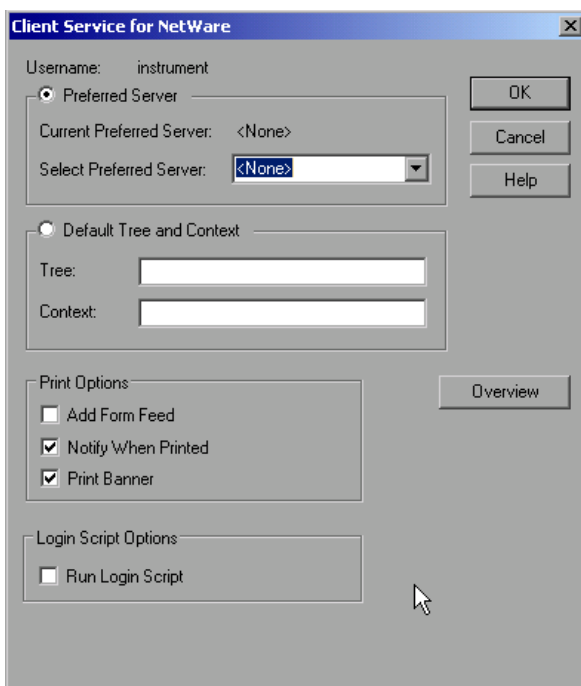

Bindary login (NOVELL 3.x)

- Click "Preferred Server".
- Select the NOVELL server where the user is configured using "Select Preferred Server".

NDS login (more recent NOVELL versions)

- Click "Default Tree and Context".
- Enter the NDS Tree under "Tree" and the hierarchical path where the user is defined under "Context".
- If required, click the "Run Login Script" entry.

Note: *This data can be obtained from the network administrator.*

- Terminate the Login configuration with "OK".

Login in the Network

The user automatically logs into the network with the registration in the operating system. As a prerequisite, the user name and the password must be identical under Windows XP and on the network.

Disabling the Autologin Mechanism

Upon delivery, the instrument is configured for automatic login into Windows XP. This mechanism must be disabled if the instrument is operated in a network, since the default user name ("instrument") and the password normally are not identical to those of the network account.

To disable the autologin mechanism, proceed as follows:

- Open the XP start menu by means of <CTRL><ESC>.
- Select the menu item "RUN". A dialog box opens.
- Enter the command "D:\USER\NO_AUTOLOGIN.REG" in the dialog box and confirm with <ENTER>.

The autologin mechanism is disabled. When the instrument is rebooted, a prompt for user name and password will appear before the instrument firmware is started.

Reenabling the Autologin Mechanism

To enable the autologin mechanism again, proceed as follows:

- Open the XP start menu by means of <CTRL><ESC>.
- Select the menu item "RUN". A dialog box opens.
- Enter the command "D:\USER\AUTOLOGIN.REG" in the dialog box and confirm with <ENTER>.

The autologin mechanism is reenabled and is active when the instrument is rebooted the next time.

Using Network Drives

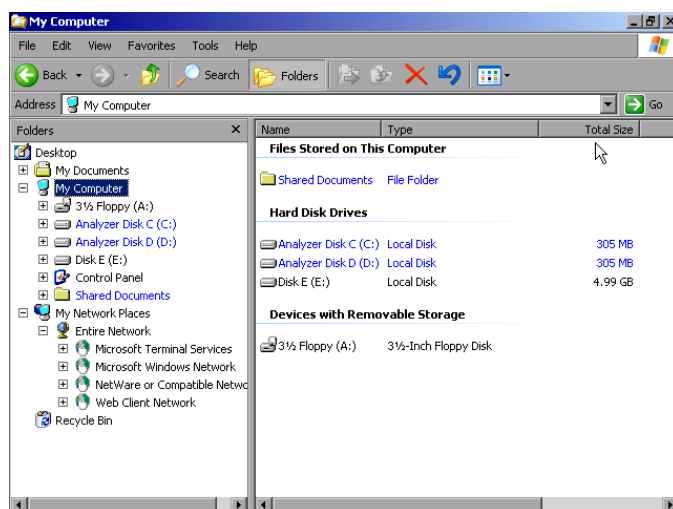

Mapping a network drive:

- Use the Windows key or the key combination <CTRL> <ESC> to call the Windows XP start menu.
- Click "Programs", "Accessories", "Windows Explorer" one after the other.
- Click the line "My Network Places" in the overview "Desktop".

An overview of the available network drives is displayed.

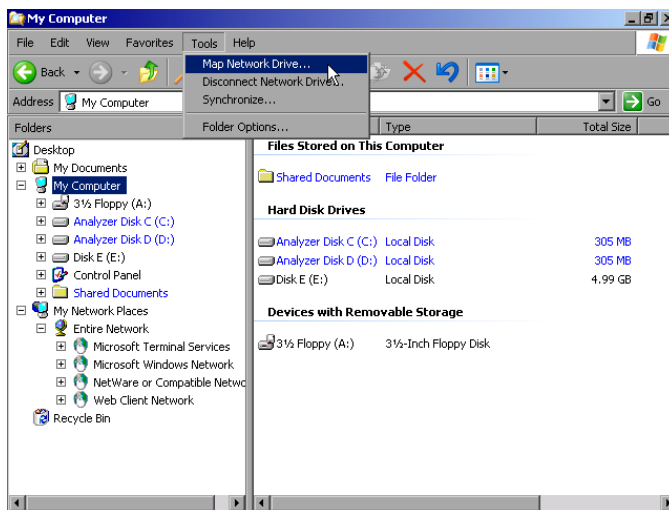

- Click "Tools" and then "Map Network Drive".

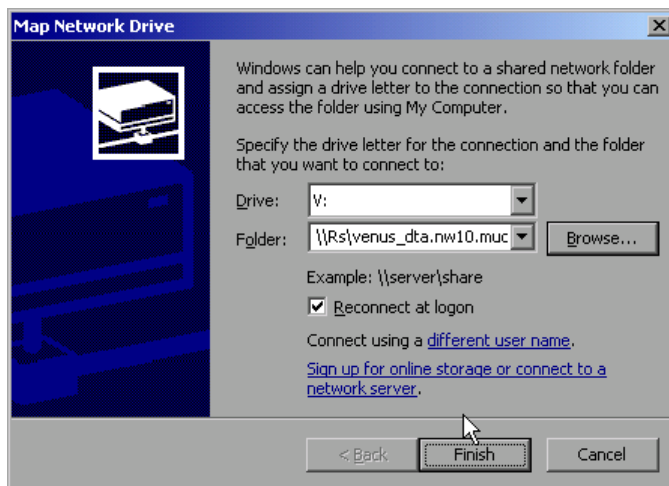

- Select the appropriate drive under "Drive:".
- With "Browse", open the list of available network paths in the network.
- Activate "Reconnect at Logon:" if the connection is to be set up automatically each time the instrument is started.
- Use "Finish" to connect the network path with the selected drive.

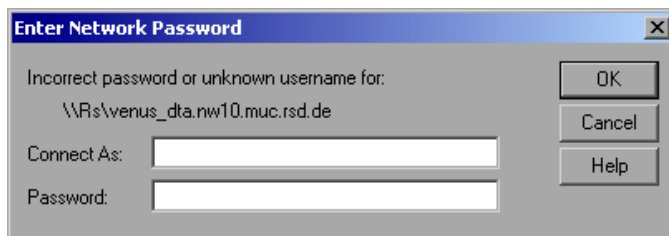

The user name and the password are queried. Then the drive will appear in the "All Directories" overview of the explorer.

- Note:** Only those drives in the network for which the user has the appropriate access right can be connected.

Disconnecting a network drive:

- Click "Tools" in the Explorer and then "Disconnect Network Drive".
- Select the drive to be disconnected under "Network Drive:".
- Disconnect the drive using "OK". The security prompt must be answered with "Yes".

Printing on a Network Printer

Note:

The following dialogs may be operated both via the front panel and via a mouse and PC keyboard (for further information see the sections "Connection of a Mouse" and "Connection of a Keyboard"). The mouse and the PC keyboard are indispensable for the configuration of network printers.

A new printer is installed via the *INSTALL PRINTER* softkey in the *HCOPY* menu.

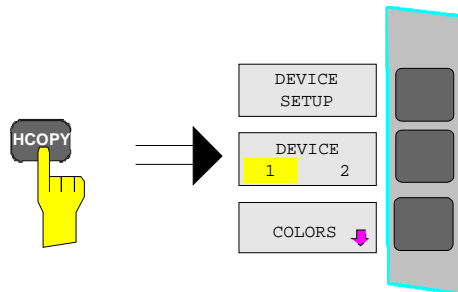

-
- Press the *HCOPY* key.
The *HCOPY* menu will be opened.

-
- Call up the lateral menu via the *NEXT* key.

-
- Open the *Printers and Faxes* dialog with *INSTALL PRINTER*.

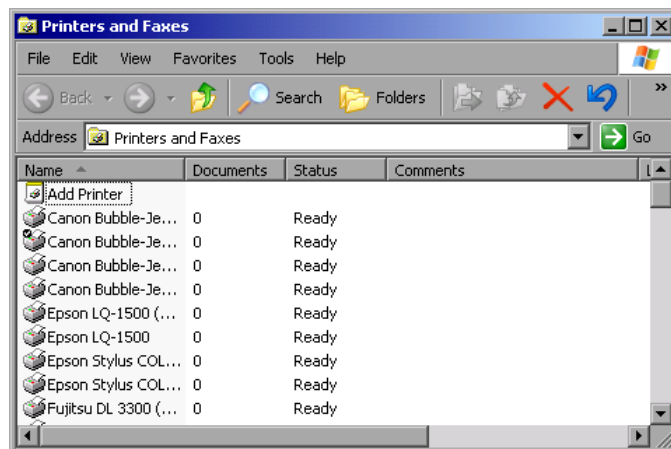

-
- Select the entry *Add Printer* in the selection list using the spinwheel.
 - Highlight the entry with *CURSOR RIGHT* and confirm the selection by pressing *ENTER* or the spinwheel.
The *Add Printer Wizard* will be displayed.

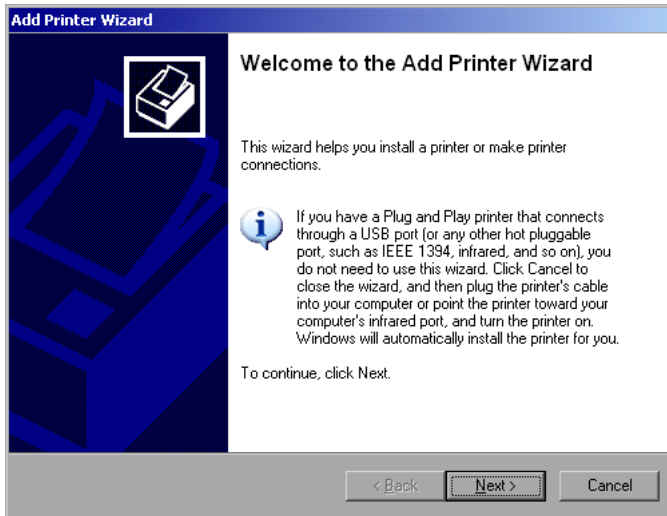

- Select *NEXT* with the spinwheel and confirm by pressing the spinwheel.

The selection *Local or Network Printer* will be displayed.

In the following example, an HP Laserjet 5 printer will be installed as the network printer. The Add Printer Wizard has already been opened according to the information described in the section "Starting the Add Printer Wizard".

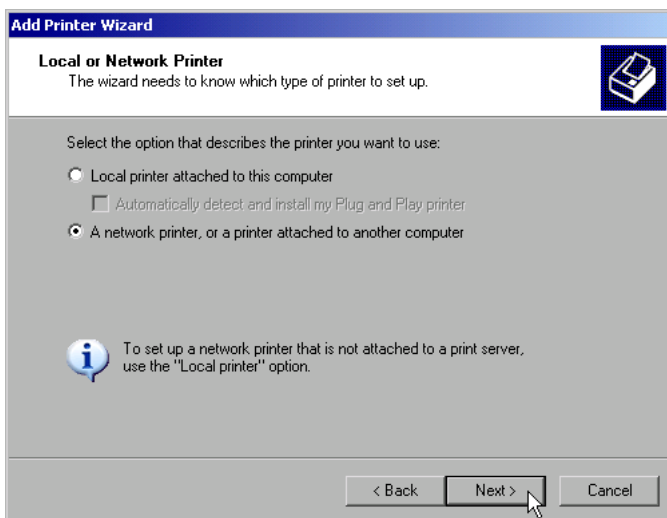

- To select a network printer, click the line "A network printer or a printer attached to another computer".

Then continue with "Next" .

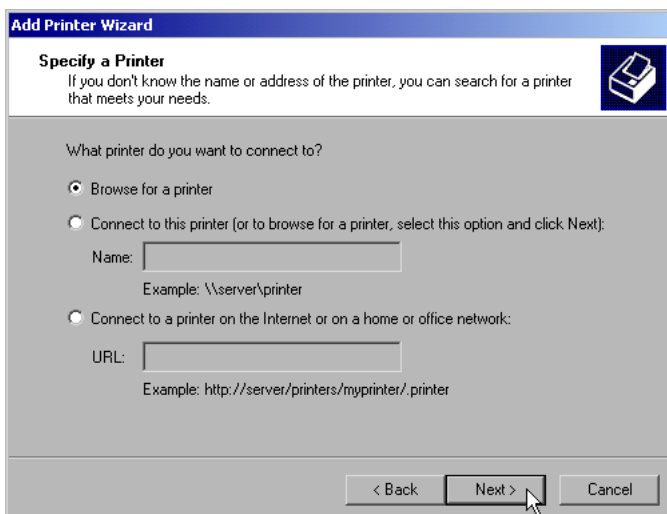

- First click "Browse for a printer" and then "Next" .

The selection of shared printers will appear.

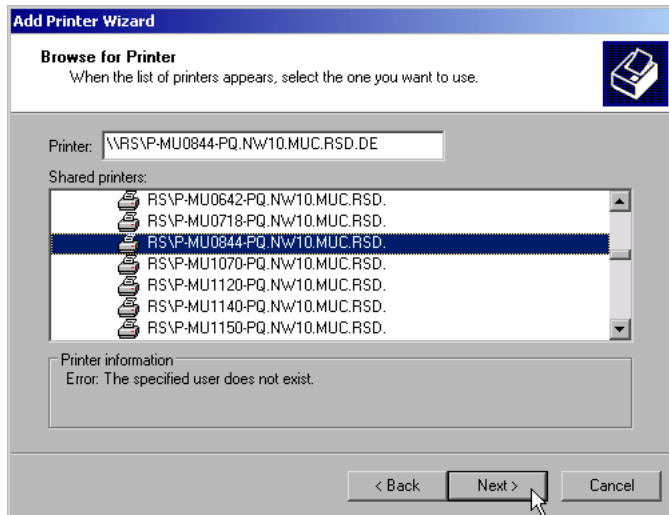

- Highlight printer and select with "OK".

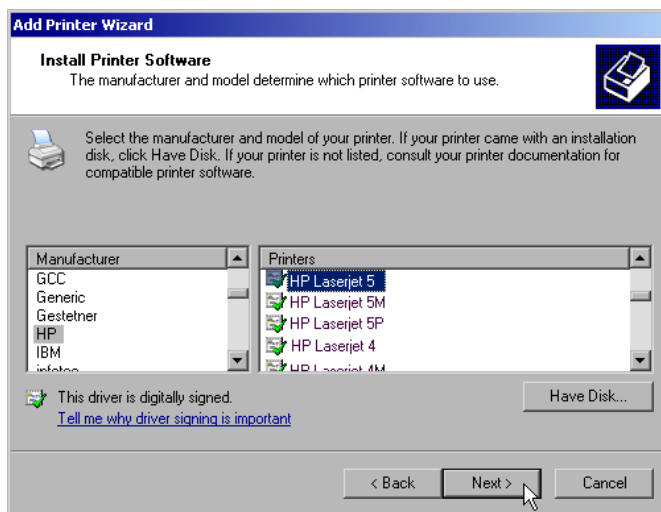

- Confirm the following request to install a suitable printer driver using "OK".

The selection of printer drivers will be displayed.

The manufacturers are displayed in the left-hand table and the available printer drivers in the right-hand table.

- First highlight the manufacturer in the selection list "Manufacturers" and then the printer driver in the selection list "Printers".

Note:

If the desired printer type does not appear in this list, the driver has not yet been installed in the instrument. In this case, click the "HAVE DISK" button. A request to insert a disk with the corresponding printer driver will appear. Then click "OK" and select the desired printer driver.

- Click "Next".

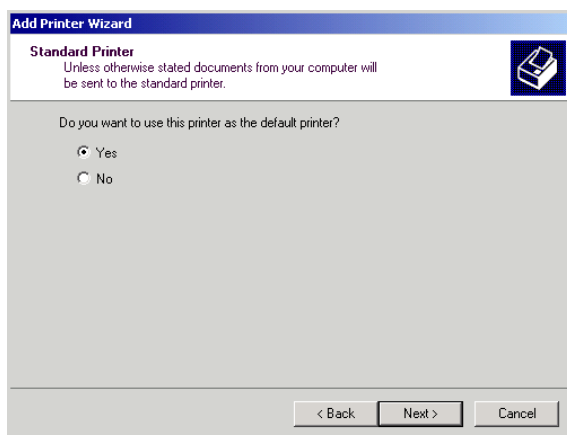

If one or several printers have already been installed, the query of whether the printer installed so far is to be selected as the default printer for the Windows XP applications will be displayed. "No" is preset.

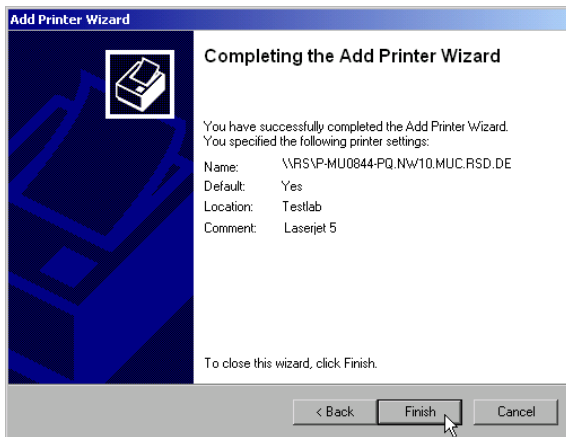

- Start the installation of the printer driver with "Finish".

Finally, the instrument still has to be configured for printout via this printer with the softkeys DEVICE SETUP and DEVICE 1/2 in the main hardcopy menu (see section "Selecting a Printer").

Sharing Directories (only for Microsoft Networks)

Data on the instrument can be made available for other computers if directories are shared. Sharing directories is only possible in the MICROSOFT network.

Sharing is a property of a file or directory. To allow sharing, proceed as follows:

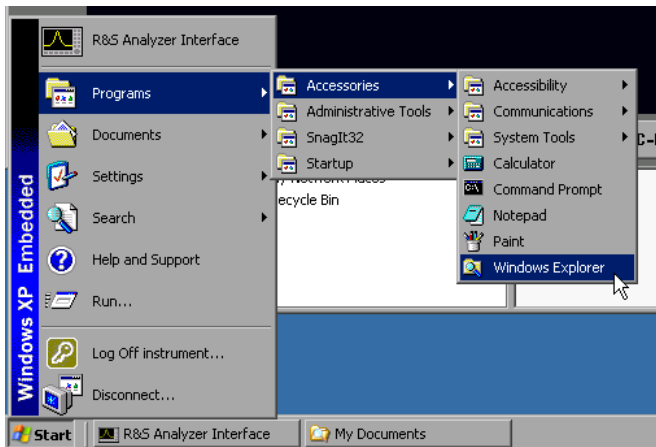

- Open the Windows start menu using the Windows key or <CTRL><ESC>.
- Open the Windows Explorer by clicking Programs - Accessories - Windows Explorer.

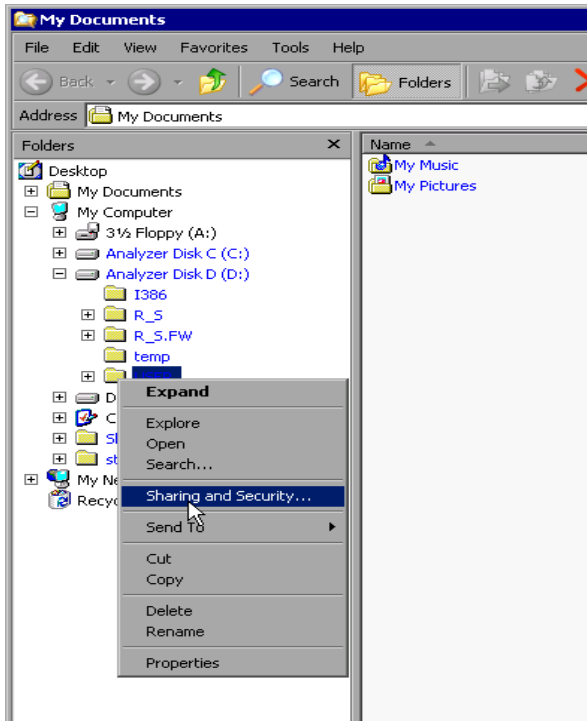

- Click the desired folder with the right mouse key.
- Click Sharing and Security.

The dialog to share the directories will be opened.

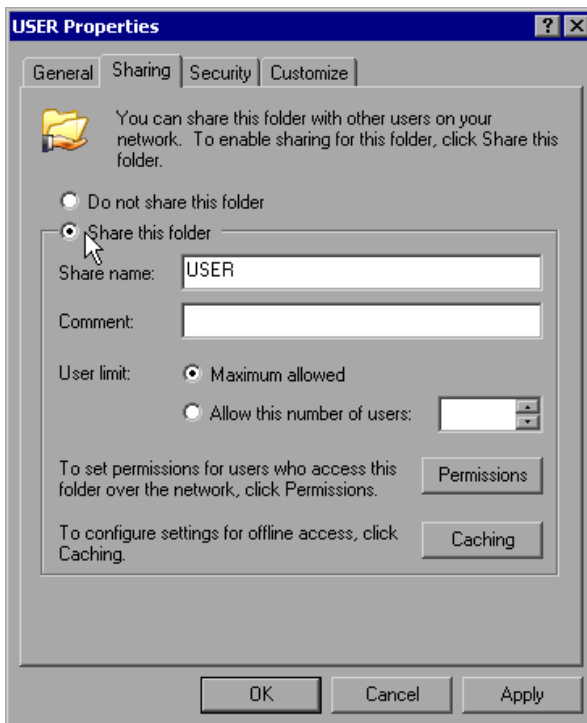

- Click *Share this folder*.
- The following settings can optionally be changed:
 - Share name:*
the name under which the directory appears in the Explorer
 - Comment:*
a comment regarding the shared directory
 - User Limit:*
the number of users that may access the directory at the same time
 - Permissions:*
the rights of the users (read only, read and write, all)
 - Caching:*
local buffering of directory contents for fast access
- Confirm settings with *OK*.

The drive is shared and this is shown in the Explorer by a hand under the directory symbol:



Remote Monitoring of R&S ESCI via XP Remote Desktop

Introduction

In production test and measurements, the question of how to centrally monitor measuring instruments that are used for remote servicing/diagnostics is often arises. With the remote desktop of Windows XP, the new Spectrum Analyzer Family R&S ESCI offers ideal preconditions for use in production:

- Access to operating functions via virtual front panel (*soft front panel*)
- Printout of measurement results directly from the controller
- Storing measurement data to the hard disk of the controller

The analyzer is connected via LAN. XP also supports the connection via data transmission (via modem). This section describes the configuration of R&S ESCI and the remote desktop client of the control PC. For details on setting up the data transmission link, see relevant XP literature.

Configuration of R&S ESCI for Using Remote Desktop

The following steps are required to allow an external PC access to the desktop of the R&S FSP.

1. Determine the IP configuration of the network link:

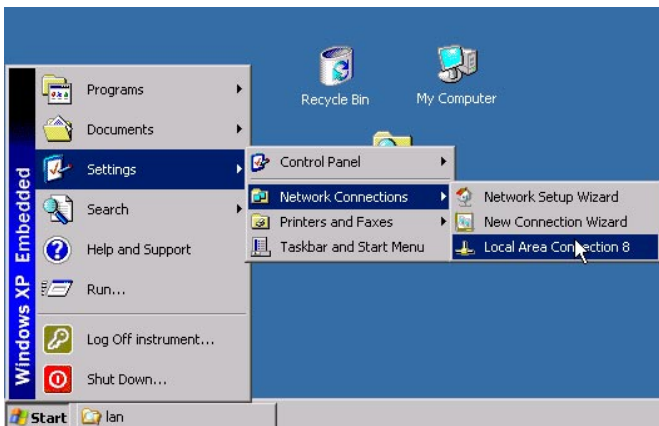

- Open the Windows XP start menu using the Windows key or *CTRL-ESC*.
- Click *Settings - Network Connections - Local Area Connection*.

The *Local Area Connection Status* dialog will be opened.

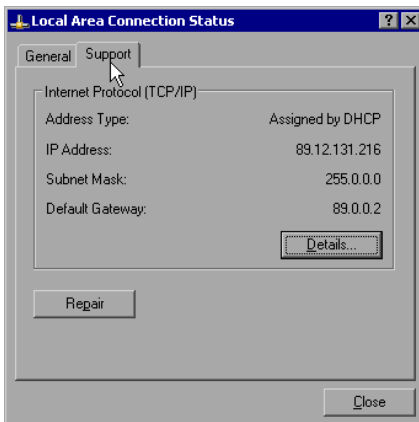

- Click the *Support* tab.

The current TCP/IP configuration will be displayed.

If the entry "Assigned by DHCP" is displayed in the *Address Type* field, continue with step 2 (Installing a fixed IP address...)

It would otherwise be sufficient to note the IP address and to continue with step 3 (Enabling the R&S ESCI...)

2. Install a fixed IP address for the TCP/IP protocol as described in the Section "Configuration of Available Network Protocols (TCP/IP Protocol)".

Note:

Operation with a fixed IP address is strongly recommended.

When a DHCP server is used, a new IP address (which has to be determined first) will be assigned any time the instrument is restarted. For this reason, a DHCP server would not be suitable for use for detached operation of the R&S ESCI.

3. Enable the R&S ESCI for operation with the remote desktop.

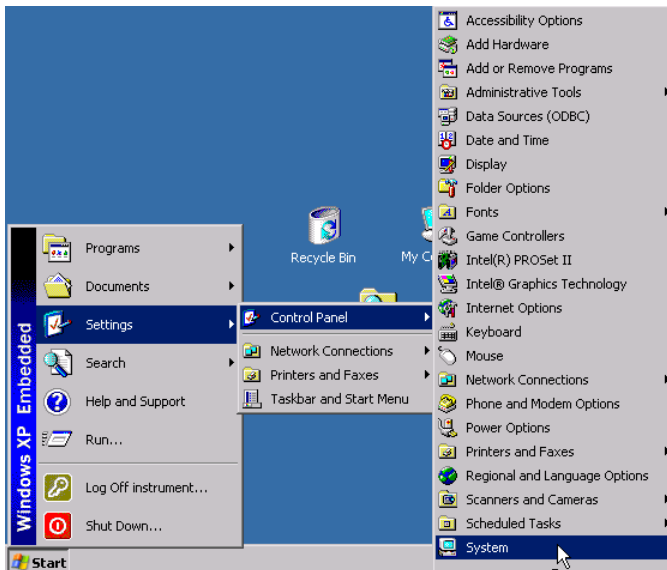

- Press the Windows key or <CTRL><ESC>.
- The Windows start menu will be opened.
- Select Settings - Control Panel - System.

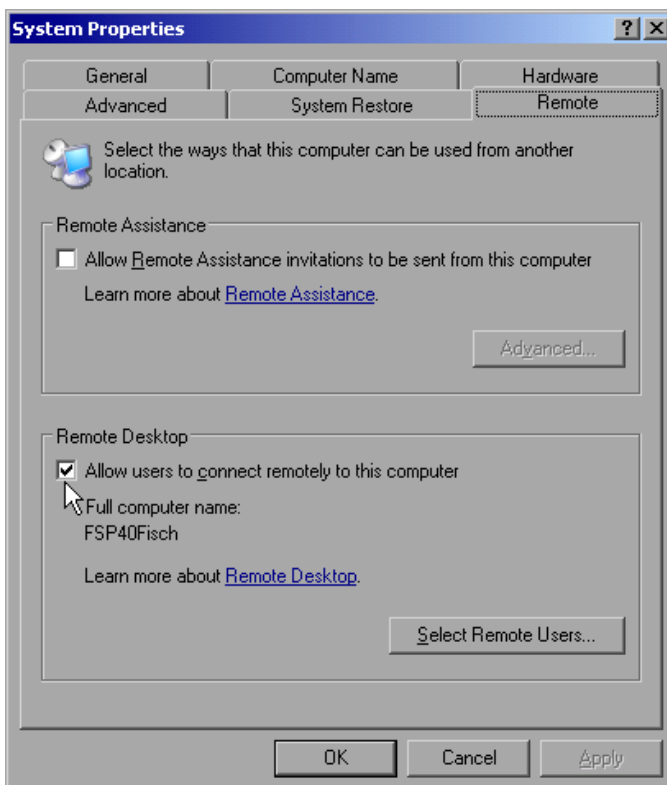

- Select the *Remote* tab.
- In the *Remote Desktop* field, tick the box in front of *Allow users to connect remotely to this computer*.
- If required, select the users installed on the R&S FSP who are to also have access to the R&S FSP via remote desktop in the *Select Remote Users...* dialog.

Note:

The user account under which the configuration is to be performed is automatically enabled for remote desktop.

- Confirm setting with *OK*.

The R&S ESCI is therefore ready for setting up the connection with the remote desktop of the controller.

Configuration of Controller

A precondition for the operation of the remote desktop is the availability of the TCP/IP protocol on the controller and the installation of the remote desktop client.

Note:

For Windows XP, the remote desktop client is part of the operating system and available under Start - Programs - Accessories - - Communications - Remote Desktop Connection.

For other Windows versions, Microsoft offers the remote client as a separate program package for subsequent installation.

The settings on the remote desktop client of the controller must be made prior to setting up the connection with the R&S FSP. The following steps are required:

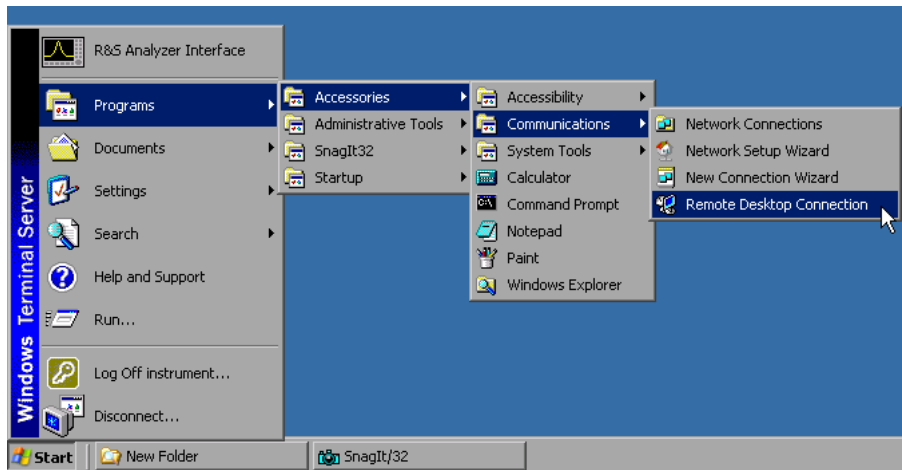

- Press the Windows key or <CTRL><ESC>.
- Select Programs - Accessories - Communications - Remote Desktop Connection.

The Remote Desktop Connection screen will be opened.

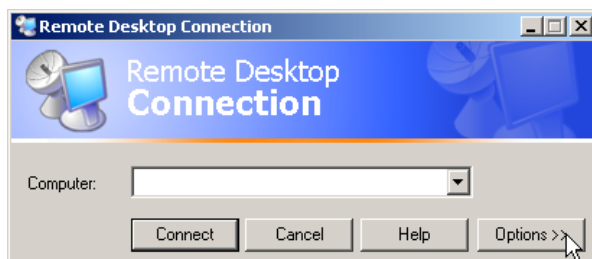

- Click the *Options >>* button.

The tabs with the configuration data will be opened.

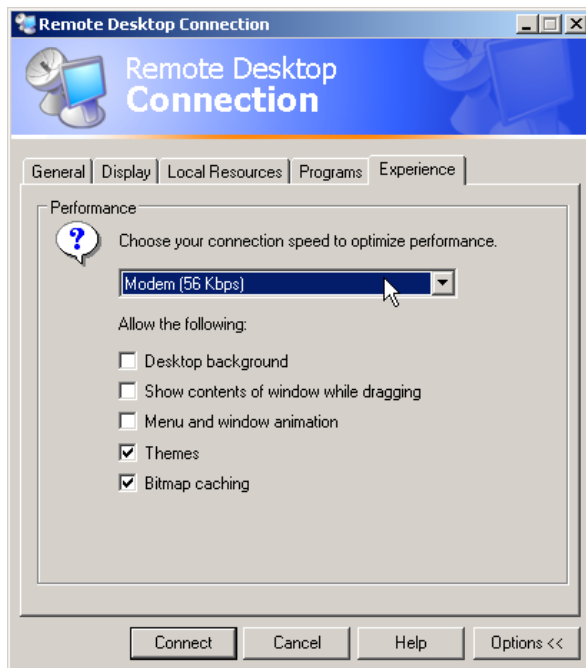

- Select the *Experience* tab.
The speed of setting up the connection will be selected and optimized.
- Click the selection list under *Choose your connection speed to optimize performance*.

The list of available configurations will be opened.

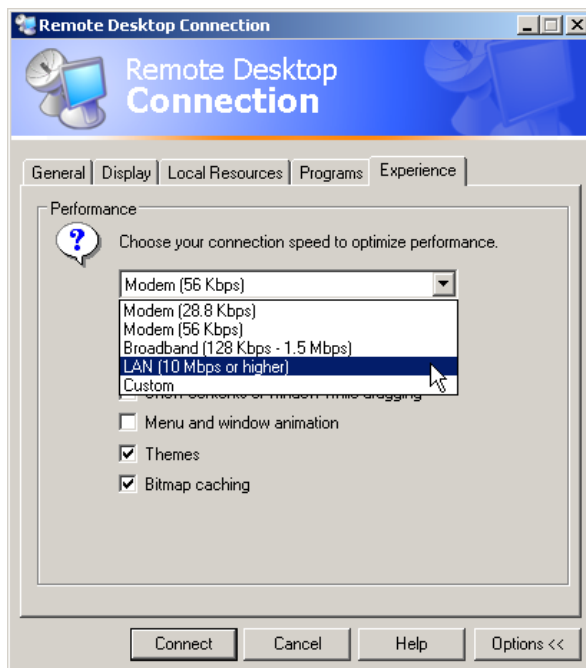

- Select the suitable connection (in the example LAN (10 Mbps or higher)).

Different boxes in the list below are activated depending on the selection and depending on the performance of the connection.

- To improve the performance, the entries "Desktop background", "Show Contents of Window while dragging" and "Menu and Window animation" can be switched off.
- Click the *Local Resources* tab.
The tab to share printers, local drives and serial interfaces will be opened.



- Click the box in front of *Disk drives* if drives of the controller are to be accessed from the R&S FSP (e.g. to save settings or to copy files from the controller to the R&S FSP).
Windows XP will then map the drives of the controller like network drives on the R&S ESCI.
- Click the box in front of *Printers* if printers connected to the controller are to be used from the R&S ESCI.
- Do not change the other settings.
- Click the *Display* tab.
The configuration of the representation of the R&S ESCI screen on the controller will be opened.

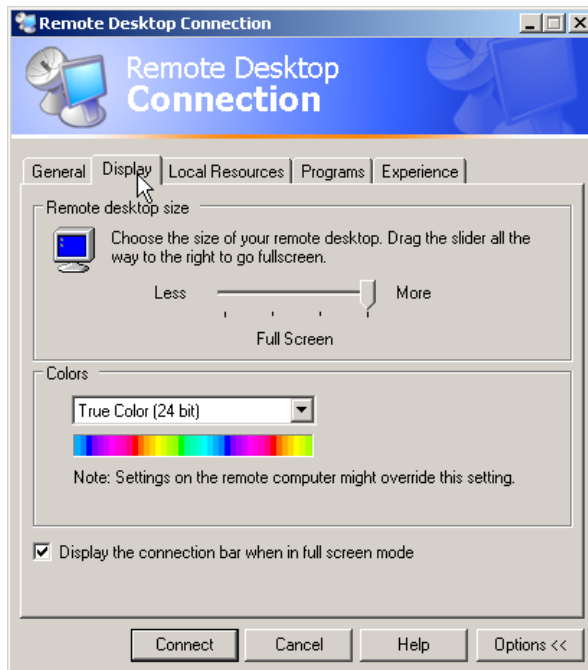

- The size of the R&S FSP window on the desktop of the controller can be changed by means of the slider. The default setup is full screen.
- Do not change the colour depth.
- *Display the connection bar when in full screen mode:*
If this box is checked, a bar will appear at the top screen margin. This bar displays the network address of the R&S ESCI and can be used to reduce, minimize or to close the window.
If the box is not checked, a return from the R&S ESCI screen to the controller desktop in the full-screen mode is possible only if "Disconnect" is selected in the start menu:

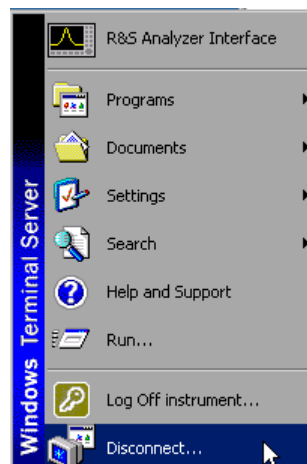

Setting up the Connection with the R&S ESCI

After configuration of the remote desktop client, the connection with the R&S ESCI has to be set up.

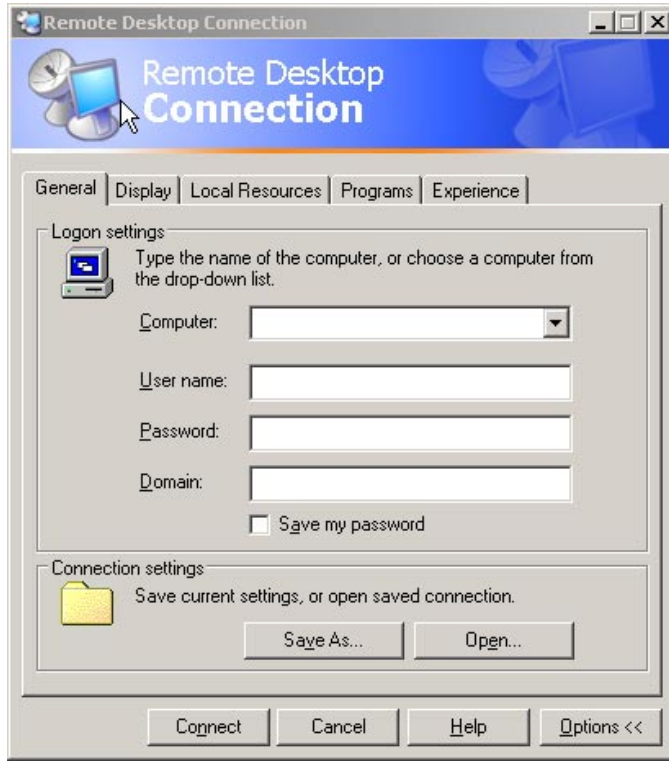

- Click the *General* tab. The connection information will be entered.
- Enter the IP address of the R&S ESCI in the *Computer* field.
- The information can be stored via the *Save As...* button for the next time. With the *Open...* button, it is possible to load an existing configuration again.
- Press the *Connect* button. The connection will be set up.

Note:

If the entry *Disk Drives* is active in the *Local Resources* tab, a warning is issued that the drives will be shared for access from the R&S ESCI:



Confirm the warning with OK. The setup will be continued.

The R&S FSP screen will appear on the controller screen with the request to log in. To allow remote control of the R&S ESCI, the following steps have to be carried out:



- Enter user name "instrument" and password "instrument".

The R&S ESCI screen will be opened in a few moments.

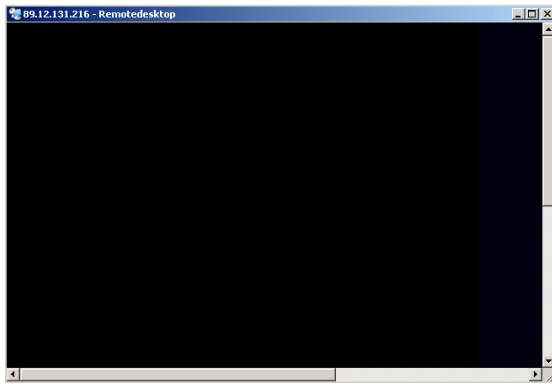

If the screen is dark or if a dark rectangle appears in the upper left corner, the R&S ESCI firmware must be restarted in order to recognize the modified screen resolution. In this case:

- Press <ALT><F4>. The R&S FSP firmware will be shut down. This may last for several seconds.

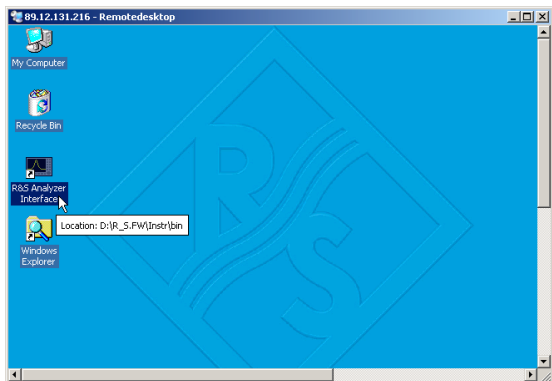

- Double-click the entry *R&S Analyzer Interface*.

The firmware will restart and will automatically open the *Soft Frontpanel*, i.e. the user interface in which all front panel buttons and the spinwheel are shown.

- If the R&S FSP application is directly displayed after setup, shutdown and restart can be omitted.

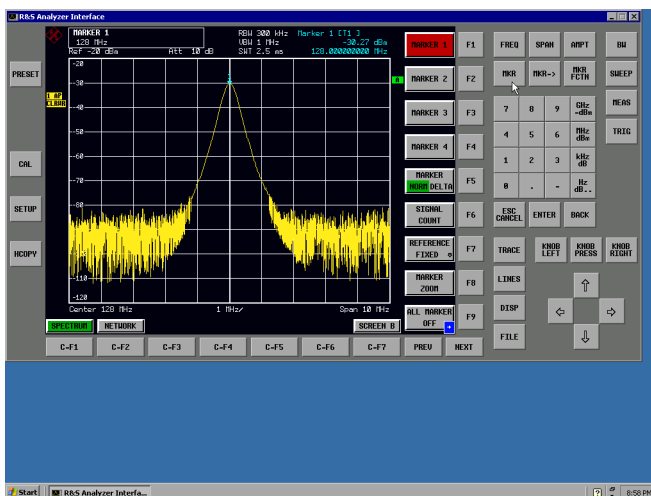

- All hardkeys, softkeys and hotkeys can be operated with the mouse.
- The spinwheel is implemented by *KNOB LEFT*, *KNOB RIGHT* and *KNOB PRESS*.
- The XP start menu is available if the remote desktop window is enlarged to full size.

Interruption and Re-setup of Remote Desktop Connection with the R&S ESCI

The connection to the R&S ESCI can be interrupted any time if the remote desktop window is connected to the controller.

To reestablish the connection, the setup with the R&S ESCI only has to be performed again as described in the section "Setting up the Connection with the R&S ESCI". The R&S ESCI will then maintain its state in case of an interruption with a subsequent re-setup.

When the connection is set up with the controller, the login entry will be displayed on the R&S ESCI screen. If the login procedure is carried out successfully, the message that a different user has assumed control of the instrument and that the connection was therefore cleared will be displayed on the screen of the controller.

Switching off the R&S ESCI from the Controller

The R&S ESCI can be switched off per remote control. For this purpose, proceed as follows:

1. Click the R&S ESCI soft front panel and close the application with <ALT><F4> .
2. Click the desktop and press <ALT><F4>.

A confirmation query with the warning that the instrument cannot be switched on again via remote control is displayed with the query to continue the shutdown process.
3. Answer the confirmation query with YES.

The connection to the controller will then be cleared and the R&S ESCI will be switched off.

Remote Data Transfer with TCP/IP Services

The protocol TCP/IP allows the transfer of files between different computer systems. This requires a program running on the two computers that controls this data transfer. It is not necessary that the same operating or file system is used by both computers. For example, a file transfer between DOS/WINDOWS and UNIX is possible. One of the two partners must be configured as Host and the other one as Client. However, they may change their roles. Usually, the system which is able to perform several processes at the same time will play the host role. The file transfer program usually used under TCP/IP is FTP (File Transfer Protocol). An FTP host is installed as standard on the majority of UNIX systems.

If the TCP/IP services are installed, a terminal connection is possible using "Start" - "Programs" - "Accessories" - "Telnet" or a data transfer via FTP by means of "Start" - "Run" "ftp" - "OK". Thus all computer systems supporting these universal protocols can be addressed (UNIX, VMS, etc).

For further information, refer to the corresponding XP literature.

File Transfer via FTP

The total scope of functions and commands is described in the FTP literature. The following table therefore only contains the major functions:

Setting up the connection

Click "Start" and then "Run" in the task bar.

The DOS command

FTP

starts the program.

The command

OPEN <xx.xx.xx.xx>

sets up the connection.

xx.xx.xx.xx = IP address e.g. 89.0.0.13

Data transfer

The command

PUT <dateiname>

transfers the data to the target system.

The command

GET <dateiname>

transfers the data from the target system.

The command

TYPE B

transfers the data in BINARY format; no conversion takes place.

The command

TYPE A

transfers the data in ASCII format, converting control characters so that text files can also be read on the target system.

Examples:

```
PUT C:\AUTOEXEC.BAT
```

sends the file AUTOEXEC.BAT to the target system.

```
LCD DATA
```

changes the current directory on the local machine to subdirectory DATA

```
CD SETTING
```

changes to the subdirectory SETTING on the target system

dateiname= File name e.g. DATA.TXT

Changing the directories

The command

```
LCD <path>
```

changes the directory on the local machine as with DOS.

The command

```
LDIR
```

shows the directory contents on the local machine.

These commands refer to the file system of the R&S ESCI. If the L is omitted ahead of the commands, they apply to the target system.

RSIB Protocol

The instrument is equipped with an RSIB protocol as standard, which allows the instrument to be controlled by means of Visual C++ and Visual Basic programs, but also by means of the Windows applications WinWord and Excel as well as National Instruments LabView, LabWindows/CVI and Agilent VEE. The control applications run on an external computer in the network.

A UNIX operating system can be installed on an external computer in addition to a Windows operating system. In this case, the control applications are created either in C or C++. The supported UNIX operating systems include:

- Sun Solaris 2.6 Sparc Station
- Sun Solaris 2.6 Intel Platform
- Red Hat Linux 6.2 x86 Processors

Remote Control via RSIB Protocol

Windows Environment

To access the measuring instruments via the RSIB protocol, the file `RSIB32.DLL` must be copied to the Windows `system32` directory or to the directory of the control applications. For 16-bit applications, the file `RSIB.DLL` must be additionally copied to the directories mentioned. The files `RSIB.DLL` and `RSIB32.DLL` are included on the instrument in directory `D:\R_S\Instr\RSIB`.

For the different programming languages, there are files available that contain the declarations of the DLL functions and the definition of the error codes.

Visual Basic (16 bit):	'RSIB.BAS'	(D:\R_S\Instr\RSIB)
Visual Basic (32 bit):	'RSIB32.BAS'	(D:\R_S\Instr\RSIB)
C:/C++:	'RSIB.H'	(D:\R_S\Instr\RSIB)

For C/C++: programs, import libraries are additionally available.

Import library for RSIB.DLL:	RSIB.LIB'	(D:\R_S\Instr\RSIB)
Import library for RSIB32.DLL:	RSIB32.LIB'	(D:\R_S\Instr\RSIB)

The control is performed using the Visual C++ or Visual Basic programs WinWord, Excel, LabView, LabWindows/CVI or Agilent VEE. Every application that can load a DLL is able to use the RSIB protocol. The programs use the IP address of the instrument or its *host name* to set up the connection.

Via VisualBasic: `ud = RSDLLibfind ("82.1.1.200", ibsta, iberr, ibcntl)`

Return to manual operation is possible via the front panel (*LOCAL* key) or via the RSIB protocol:

Via RSIB: `ud = RSDLLibloc (ud, ibsta, iberr, ibcntl);`
 `or`
 `ud = RSDLLibonl (ud, 0, ibsta, iberr, ibcntl);`

UNIX Environment

To access the measuring equipment via the RSIB interface, copy the `librsib.so.X.Y` file to a directory for which the control application has read rights. `X.Y` in the file name indicates the version number of the library, for example 1.0.

The `librsib.so.X.Y` library is created as a *shared library*. The applications using the library need not consider its version. They simply link the library with the `lrsib` option. The following instructions have to be observed so that linking can be successfully performed and the library can be found during program execution:

File link:

- Use the operating system command `ln` to create a file with the link name `librsib.so` and pointing to `librsib.so.X.Y` in a directory for which the control application has read rights. Example:

```
$ ln -s /usr/lib/librsib.so.1.0 /usr/lib/librsib.so
```

Linker options for creating applications:

- `-lrsib`: import library
- `-Lxxx`: path information where the import library can be found. This is where the above file link has been created. Example: `-L/usr/lib`.

Additional linker options for creating applications (only under Solaris):

- `-Rxxx`: path information where the library is searched for during the program run:
`-R/usr/lib`.

Run-time environment:

- Set environment variable `LD_RUN_PATH` to the directory in which the file link has been created. This is necessary only if `librsib.so` cannot be found in the default search path of the operating system and the `-R` linker option (only Solaris) was not specified.

For C/C++ programming, the declarations of the library functions and the definition of error codes are contained in:

```
C/C++:          'RSIB.H'          (D:\R_S\Instr\RSIB)
```

RSIB Interface Functions

This chapter lists all functions of the DLL "RSIB.DLL" or "RSIB32.DLL" or "librsib.so", which allow control applications to be produced.

Overview of Interface Functions

The library functions are adapted to the interface functions of National Instruments for GPIB programming. The functions supported by the libraries are listed in the following table.

Function	Description
RSDLLibfind()	Provides a handle for access to a device.
RSDLLibwrt()	Sends a zero-terminated string to a device.
RSDLLilwrt()	Sends a certain number of bytes to a device.
RSDLLibwrtf()	Sends the contents of a file to a device.
RSDLLibrd()	Reads data from a device into a string.
RSDLLilrd()	Reads a certain number of bytes from a device.
RSDLLibrdf()	Reads data from a device into a file.
RSDLLibtmo()	Sets timeout for RSIB functions.
RSDLLibsre()	Switches a device to the local or remote state.
RSDLLibloc()	Temporarily switches a device to the local state.
RSDLLibeot()	Enables/disables the END message for write operations.
RSDLLibrsp()	Performs a serial poll and provides the status byte.
RSDLLibonl()	Sets the device online/offline.
RSDLLTestSrqr()	Checks whether a device has generated an SRQ.
RSDLLWaitSrqr()	Waits until a device generates an SRQ.
RSDLLSwapBytes	Swaps the byte sequence for binary numeric display (only required for non-Intel platforms).

Variables `ibsta`, `iberr`, `ibcntl`

As with the National Instrument interface, the successful execution of a command can be checked by means of the variables `ibsta`, `iberr` and `ibcntl`. For this purpose, all RSIB functions are assigned references to these three variables.

Status word - `ibsta`

The status word `ibsta` provides information on the status of the RSIB interface. The following bits are defined:

Bit designation	Bit	Hex code	Description
ERR	15	8000	Is set when an error has occurred on calling a function. If this bit is set, <code>iberr</code> contains an error code that specifies the error in greater detail.
TIMO	14	4000	Is set when a timeout has occurred on calling a function.
CMPL	8	0100	Is set if the response of the GPIB parser has been read out completely. If a parser response is read out with the function <code>RSDLLi1rd()</code> and the length of the buffer is insufficient for the answer, the bit will be cleared.

Error variable - `iberr`

If the ERR bit (8000h) is set in the status word, `iberr` contains an error code which allows the error to be specified in greater detail. Extra error codes are defined for the RSIB protocol, independent of the National Instruments interface.

Error	Error code	Description
IBERR_CONNECT	2	Setup of the connection to the measuring instrument has failed.
IBERR_NO_DEVICE	3	A function of the interface has been called with an illegal device handle.
IBERR_MEM	4	No empty memory available.
IBERR_TIMEOUT	5	Timeout has occurred.
IBERR_BUSY	6	The RSIB protocol is blocked by a function that is still running.
IBERR_FILE	7	Error when reading or writing to a file.
IBERR_SEMA	8	Error upon creating or assigning a semaphore (only under UNIX).

Count variable - `ibcntl`

The variable `ibcntl` is updated with the number of transferred bytes each time a read or write function is called.

Description of Interface Functions

RSDLLibfind()

The function provides a handle for access to the device with the name udName.

VB format: Function RSDLLibfind (ByVal udName\$, ibsta%, iberr%, ibcntl&) As Integer

C format: short WINAPI RSDLLibfind(char far *udName, short far *ibsta, short far *iberr, unsigned long far *ibcntl)

C format (UNIX): short RSDLLibfind(char *udName, short *ibsta, short *iberr, unsigned long *ibcntl)

Parameters: udName IP address of device

Example: ud = RSDLLibfind ("89.10.38.97", ibsta, iberr, ibcntl)

The function must be called prior to all other functions of the interface.

As return value, the function provides a handle that must be indicated in all functions for access to the device. If the device with the name udName is not found, the handle has a negative value.

RSDLLibwrt

This function sends data to the device with the handle ud.

VB format: Function RSDLLibwrt (ByVal ud%, ByVal Wrt\$, ibsta%, iberr%, ibcntl&) As Integer

C format: short WINAPI RSDLLibwrt(short ud, char far *Wrt, short far *ibsta, short far *iberr, unsigned long far *ibcntl)

C format (UNIX): short RSDLLibwrt(short ud, char *Wrt, short *ibsta, short *iberr, unsigned long *ibcntl)

Parameters: ud Device handle
Wrt String sent to the device.

Example: RSDLLibwrt(ud, "SENS:FREQ:STAR?", ibsta, iberr, ibcntl)

This function allows setting and query commands to be sent to the measuring instruments. Whether the data is interpreted as a complete command can be set using the function RSDLLibeot().

RSDLLilwrt

This function sends Cnt bytes to a device with the handle ud.

VB format: Function RSDLLilwrt (ByVal ud%, ByVal Wrt\$, ByVal Cnt&, ibsta%, iberr%, ibcntl&) As Integer

C format: short WINAPI RSDLLilwrt(short ud, char far *Wrt, unsigned long Cnt, short far *ibsta, short far *iberr, unsigned long far *ibcntl)

C format (UNIX): short RSDLLilwrt(short ud, char *Wrt, unsigned long Cnt, short *ibsta, short *iberr, unsigned long *ibcntl)

Parameters: ud Device handle
Wrt String sent to the GPIB parser.
Cnt Number of bytes sent to the device.

Example: RSDLLilwrt (ud, '.....', 100, ibsta, iberr, ibcntl)

Like RSDLLibwrt() this function sends data to a device. The only difference is that binary data can be sent as well. The length of the data is not determined by a zero-terminated string, but by the indication of Cnt bytes. If the data is to be terminated with EOS (0Ah), the EOS byte must be appended to the string.

RSDLLibwrtf

This function sends the contents of a file `file$` to the device with the handle `ud`.

VB format: Function RSDLLibwrtf (ByVal ud%, ByVal file\$, ibsta%, iberr%, ibcntl&) As Integer

C format: short WINAPI RSDLLibwrt(short ud, char far *Wrt, short far *ibsta, short far *iberr, unsigned long far *ibcntl)

C format (UNIX): short RSDLLibwrt(short ud, char *Wrt, short *ibsta, short *iberr, unsigned long *ibcntl)

Parameters: ud Device handle
file File whose contents is sent to the device.

Example: RSDLLibwrtf(ud, "C:\db.sav", ibsta, iberr, ibcntl)

This function allows setting and query commands to be sent to the measuring instruments. Whether the data is interpreted as a complete command can be set using the function RSDLLibeot().

RSDLLibrd()

The function reads data from the device with the handle `ud` into the string `Rd`.

VB format: Function RSDLLibrd (ByVal ud%, ByVal Rd\$, ibsta%, iberr%, ibcntl&) As Integer

C format: short WINAPI RSDLLibrd(short ud, char far *Rd, short far *ibsta, short far *iberr, unsigned long far *ibcntl)

C format (UNIX): short RSDLLibrd(short ud, char *Rd, short *ibsta, short *iberr, unsigned long *ibcntl)

Parameters: ud Device handle
Rd String to which the read data is copied.

Example: RSDLLibrd (ud, Rd, ibsta, iberr, ibcntl)

This function fetches the responses of the GPIB parser to a query.

In the case of Visual Basic programming, a string of sufficient length must be generated beforehand. This can be done during the definition of the string or using the command `Space$()`.

Generation of a string of the length 100: - Dim Rd as String * 100
 - Dim Rd as String
 Rd = Space\$(100)

RSDLLilrd

This function reads `Cnt` bytes from the device with the handle `ud`.

VB format: Function RSDLLilrd (ByVal ud%, ByVal Rd\$, ByVal Cnt&, ibsta%, iberr%, ibcntl&) As Integer

C format: short WINAPI RSDLLilrd(short ud, char far *Rd, unsigned long Cnt, short far *ibsta, short far *iberr, unsigned long far *ibcntl)

C format (UNIX): short RSDLLilrd(short ud, char *Rd, unsigned long Cnt, short *ibsta, short *iberr, unsigned long *ibcntl)

Parameters: ud Device handle
cnt Maximum number of bytes copied from the DLL into the target string `Rd`.

Example: RSDLLilrd (ud, RD, 100, ibsta, iberr, ibcntl)

Like the function `RSDLLibrd()`, this function reads data from a device. The only difference is that in this case the maximum number of bytes to be copied to the target string `Rd` can be indicated by means of `Cnt`. This function prevents writing beyond the end of the string.

RSDLLibrdf()

Reads data from the device with the handle `ud` into the file `file`.

VB format: Function RSDLLibrdf (ByVal ud%, ByVal file\$, ibsta%, iberr%, ibcntl&) As Integer

C format: short WINAPI RSDLLibrd(short ud, char far *file, short far *ibsta, short far *iberr, unsigned long far *ibcntl)

C format (UNIX): short RSDLLibrd(short ud, char *file, short *ibsta, short *iberr, unsigned long *ibcntl)

Parameters: ud Device handle
file File to which the read data is written.

Example: RSDLLibrdf (ud, "c:\db.sav", ibsta, iberr, ibcntl)

The file name may as well include a drive or path specification.

RSDLLibtmo

This function defines the timeout for a device. The default value for the timeout is set to 5 seconds.

VB format: Function RSDLLibtmo (ByVal ud%, ByVal tmo%, ibsta%, iberr%, ibcntl&) As Integer

C format: void WINAPI RSDLLibtmo(short ud, short tmo, short far *ibsta, short far *iberr, unsigned long far *ibcntl)

C format (UNIX): short RSDLLibtmo(short ud, short tmo, short *ibsta, short *iberr, unsigned long *ibcntl)

Parameters: ud Device handle
tmo Timeout in seconds

Example: RSDLLibtmo (ud, 10, ibsta, iberr, ibcntl)

RSDLLibsre

This function sets the device to the 'LOCAL' or 'REMOTE' state.

VB format: Function RSDLLibsre (ByVal ud%, ByVal v%, ibsta%, iberr%, ibcntl&) As Integer

C format: void WINAPI RSDLLibsre(short ud, short v, short far *ibsta, short far *iberr, unsigned long far *ibcntl)

C format (UNIX): short RSDLLibsre(short ud, short v, short *ibsta, short *iberr, unsigned long *ibcntl)

Parameters: ud Device handle
v State of device

0 - local

1 - remote

Example: RSDLLibsre (ud, 0, ibsta, iberr, ibcntl)

RSDLLibloc

This function temporarily switches the device to the 'LOCAL' state.

VB format: Function RSDLLibloc (ByVal ud%, ibsta%, iberr%, ibcntl&) As Integer

C format: void WINAPI RSDLLibloc(short ud, short far *ibsta, short far *iberr, unsigned long far *ibcntl)

C format (UNIX): short RSDLLibloc(short ud, short *ibsta, short *iberr, unsigned long *ibcntl)

Parameter: ud Device handle

Example: RSDLLibloc (ud, ibsta, iberr, ibcntl)

After switchover to LOCAL state, the instrument can be manually operated via the front panel. On the next access to the instrument by means of one of the functions of the library, the instrument is switched again to the REMOTE state.

RSDLLibeot

This function enables or disables the END message after write operations.

VB format: Function RSDLLibeot (ByVal ud%, ByVal v%, ibsta%, iberr%, ibcntl&) As Integer

C format: void WINAPI RSDLLibsre(short ud, short v, short far *ibsta, short far *iberr, unsigned long far *ibcntl)

C format (UNIX): short RSDLLibsre(short ud, short v, short *ibsta, short *iberr, unsigned long *ibcntl)

Parameters: ud Device handle
v 0 - no END message
1 - send END message

Example: RSDLLibeot (ud, 1, ibsta, iberr, ibcntl)

If the END message is disabled, the data of a command can be sent with several successive calls of write functions. The END message must be enabled again before sending the last data block.

RSDLLibrsp

This function performs a serial poll and provides the status byte of the device.

VB format: Function RSDLLibrsp(ByVal ud%, spr%, ibsta%, iberr%, ibcntl&) As Integer

C format: void WINAPI RSDLLibrsp(short ud, char far* spr, short far *ibsta, short far *iberr, unsigned long far *ibcntl)

C format (UNIX): short RSDLLibrsp(short ud, char *spr, short *ibsta, short *iberr, unsigned long *ibcntl)

Parameters: ud Device handle
spr Pointer to status byte

Example: RSDLLibrsp(ud, spr, ibsta, iberr, ibcntl)

RSDLLibonl

This function switches the device to 'online' or 'offline' mode. When it is switched to 'offline' mode, the interface is released and the device handle becomes invalid. By calling RSDLLibfind again, the communication is set up again.

VB format: Function RSDLLibonl (ByVal ud%, ByVal v%, ibsta%, iberr%,
ibcntl&) As Integer

C format: void WINAPI RSDLLibonl(short ud, short v, short far *ibsta,
short far *iberr, unsigned long far *ibcntl)

C format: short RSDLLibonl(short ud, short v, short *ibsta, short
*iberr, unsigned long *ibcntl)

Parameters: ud Device handle
v Device state
0 - local
1 - remote

Example: RSDLLibonl(ud, 0, ibsta, iberr, ibcntl)

RSDLLTestSRQ

This function checks the status of the SRQ bit.

VB format: Function RSDLLTestSrq (ByVal ud%, Result%, ibsta%, iberr%,
ibcntl&) As Integer

C format: void WINAPI RSDLLTestSrq(short ud, short far *result, short
far *ibsta, short far *iberr, unsigned long far *ibcntl)

C format (UNIX): short RSDLLTestSrq(short ud, short *result, short *ibsta,
short *iberr, unsigned long *ibcntl)

Parameters: ud Device handle
result Reference to an integer value in which the library returns
the status of the SRQ bit
0 - no SRQ
1 - SRQ active, device requests service

Example: RSDLLTestSrq (ud, result%, ibsta, iberr, ibcntl)

This function corresponds to the function RSDLLWaitSrq. The only difference is that RSDLLTestSRQ immediately returns the current status of the SRQ bit, whereas RSDLLWaitSrq waits for an SRQ to occur.

RSDLLWaitSrq

This function waits until the device triggers an SRQ with the handle `ud`.

VB format: Function RSDLLWaitSrq (ByVal ud%, Result%, ibsta%, iberr%, ibcntl&) As Integer

C format: void WINAPI RSDLLWaitSrq(short ud, short far *result, short far *ibsta, short far *iberr, unsigned long far *ibcntl)

C format (UNIX): short RSDLLWaitSrq(short ud, short *result, short *ibsta, short *iberr, unsigned long *ibcntl)

Parameters:

<code>ud</code>	Device handle
<code>result</code>	Reference to an integer value in which the library returns the status of the SRQ bit
	0 - No SRQ occurred during the timeout
	1 - SRQ occurred during the timeout

Example: RSDLLWaitSrq(ud, result, ibsta, iberr, ibcntl);

The function waits until one of the following two events occurs.

- The measuring instrument triggers an SRQ.
- No SRQ occurs during the timeout defined with `RSDLLibtmo()`.

RSDLLSwapBytes

This function changes the display of binary numbers on non-Intel platforms.

VB format: Not provided at present since it is required only on non-Intel platforms.

C format: void WINAPI RSDLLSwapBytes(void far *pArray, const long size, const long count)

C format (UNIX): void RSDLLSwapBytes(void *pArray, const long size, const long count)

Parameters:

<code>pArray</code>	Array in which modifications are made
<code>size</code>	Size of a single element in <code>pArray</code>
<code>count</code>	Number of elements in <code>pArray</code>

Example: RSDLLSwapBytes(Buffer, sizeof(float), ibcntl/sizeof(float))

This function swaps the display of various elements from *Big Endian* to *Little Endian* and vice versa. It is expected that a coherent storage area of elements of the same file type (`size` byte) is transferred to `pArray`. This function has no effect on Intel platforms.

Different types of processor architecture store data in different byte sequences. For example, Intel processors store data in the reverse order of Motorola processors. Comparison of byte sequences:

Byte sequence	Use in	Display in memory	Description
Big Endian	Motorola processors, network standard	Most significant byte at least significant address	The <i>most significant</i> byte is at the left end of the word.
Little Endian	Intel processors	Least significant byte at least significant address	The <i>most significant</i> byte is at the right end of the word.

Programming via the RSIB Protocol

Visual Basic

Programming tips:

- Access to the functions of the RSIB.DLL

To create Visual Basic control applications, the file RSIB.BAS must be added to a project for 16-bit Basic programs and the file RSIB32.BAS for 32-bit Basic programs (D:\R_S\INSTR\RSIB) so that the functions of the RSIB.DLL or RSIB32.DLL can be accessed.

- Generating a response buffer

Prior to calling the functions `RSDLLibrd()` and `RSDLLilrd()`, a string of sufficient length must be generated. This is possible either by defining the string or using the command `Space$()`.

Generating a string of the length 100: - Dim Response as String * 100
 - Dim Response as String
 Response = Space\$(100)

If a response is to be output as a string from the measuring instrument, the appended blanks can be removed using the Visual Basic Function `RTrim()`.

Example:

```
Response = Space$(100)
Call RSDLLibrd(ud, Response, ibsta, iberr, ibcntl)
Response = RTrim(Response)
' Output of Response
```

- Reading out trace data in real format

Using the function declarations in the file RSIB.BAS or RSIB32.BAS the responses of the device can be assigned to one string only. If the data are to be read into an array with float values, the header and the useful data must be read out with separate function calls.

Example of a header

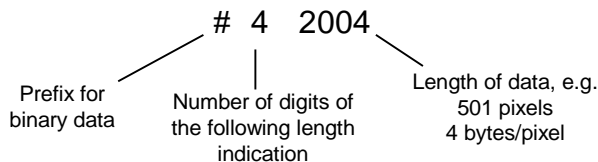

In order to enable the trace data to be directly read into a float array, a special function declaration must be created.

```
Declare Function RSDLLilrdTraceReal Lib "rsib32.dll" Alias "RSDLLilrd"
(ByVal ud%, Rd As Single, ByVal Cnt&, ibsta%, iberr%, ibcntl&) As Integer
```

Example:

```

Dim ibsta As Integer      ' Status variable
Dim iberr As Integer     ' Error variable
Dim ibcntl As Long      ' Count variable
Dim ud As Integer       ' Handle for measuring instrument
Dim Result As String    ' Buffer for simple results
Dim Digits As Byte      ' Number of digits of length indication
Dim TraceBytes As Long  ' Length of trace data in bytes
Dim TraceData(501) As Single ' Buffer for floating point
                          ' Binary data

' Set up connection to instrument
ud = RSDLLibfind("89.10.38.97", ibsta, iberr, ibcntl)

' Query trace data in real format
Call RSDLLibwrt(ud, "FORM:DATA REAL,32", ibsta, iberr, ibcntl)
Call RSDLLibwrt(ud, "TRACE? TRACE1", ibsta, iberr, ibcntl)

'Read number of digits of length indication
Result = Space$(20)
Call RSDLLilrd(ud, Result, 2, ibsta, iberr, ibcntl)
Digits = Val(Mid$(Result, 2, 1))

'Read length indication
Result = Space$(20)
Call RSDLLilrd(ud, Result, Digits, ibsta, iberr, ibcntl)
TraceBytes = Val(Left$(Result, Digits)) 'and store

' Read out trace data
Call RSDLLilrdTraceReal(ud, TraceData(0), TraceBytes, ibsta, iberr, ibcntl)

```

Programming examples:

- In this example, the start frequency of the instrument is queried.

```

Dim ibsta As Integer      ' Status variable
Dim iberr As Integer     ' Error variable
Dim ibcntl As Long      ' Count variable
Dim ud As Integer       ' Handle for measuring instrument
Dim Response As String   ' Response string

' Set up connection to measuring instrument
ud = RSDLLibfind("89.10.38.97", ibsta, iberr, ibcntl)
If (ud < 0) Then
    ' Error treatment
End If

' Send query command
Call RSDLLibwrt(ud, "FREQ:START?", ibsta, iberr, ibcntl)

' Provide space for response
Response = Space$(100)

' Read response from measuring instrument
Call RSDLLibrd(ud, Response, ibsta, iberr, ibcntl)

```

- In this example, a Save/Recall of the instrument setups is performed.

```
Dim ibsta As Integer      ' Status variable
Dim iberr As Integer      ' Error variable
Dim ibcntl As Long        ' Count variable
Dim ud As Integer         ' Handle for measuring instrument
Dim Cmd As String         ' Command string

' Set up connection to measuring instrument
ud = RSDLLibfind("89.10.38.97", ibsta, iberr, ibcntl)
If (ud < 0) Then
    ' Error treatment
End If

' Request instrument settings
Cmd = "SYST:SET?"
Call RSDLLibwrt(ud, Cmd, ibsta, iberr, ibcntl)

' Store instrument response in file
Call RSDLLibrdf(ud, "C:\db.sav", ibsta, iberr, ibcntl)

' Reset instrument
Call RSDLLibwrt(ud, "*RST", ibsta, iberr, ibcntl)

' and restore the previous settings
' to this end disable the END message
Call RSDLLibeot(ud, 0, ibsta, iberr, ibcntl)
' first send off command
Call RSDLLibwrt(ud, "SYST:SET ", ibsta, iberr, ibcntl)
' enable the END message again
Call RSDLLibeot(ud, 1, ibsta, iberr, ibcntl)
' and send the data
Call RSDLLibwrtf(ud, "C:\db.sav", ibsta, iberr, ibcntl)
```

Visual Basic for Applications (Winword and Excel)

Programming tips:

The programming language Visual Basic for Applications (VBA) is supported as a macro language by various manufacturers. The programs Winword and Excel use this language for the versions Winword 97 or Excel 5.0 and higher.

For macros created with Visual Basic for Applications, the same tips are valid as for Visual Basic Applications.

Programming example:

- Using the macro `QueryMaxPeak`, a single sweep with subsequent query of the maximum peak is performed. The result is entered in a Winword or Excel document.

```
Sub QueryMaxPeak()

    Dim ibsta As Integer      ' Status variable
    Dim iberr As Integer     ' Error variable
    Dim ibcnt1 As Long       ' transferred characters
    Dim ud As Integer        ' Unit Descriptor (handle)for instrument
    Dim Response As String   ' Response string

    ' Set up connection to measuring instrument
    ud = RSDLLibfind("89.10.38.97", ibsta, iberr, ibcnt1)
    If (ud < 0) Then
        Call MsgBox("Device with address 89.10.38.97 could" & _
            "not be found", vbExclamation)
    End
End If

    ' Determine maximum peak in the range 1-2MHZ
    Call RSDLLibwrt(ud, "*RST", ibsta, iberr, ibcnt1)
    Call RSDLLibwrt(ud, "INIT:CONT OFF", ibsta, iberr, ibcnt1)
    Call RSDLLibwrt(ud, "FREQ:START 1MHZ", ibsta, iberr, ibcnt1)
    Call RSDLLibwrt(ud, "FREQ:STOP 2MHZ", ibsta, iberr, ibcnt1)
    Call RSDLLibwrt(ud, "INIT:IMM;*WAI", ibsta, iberr, ibcnt1)
    Call RSDLLibwrt(ud, "CALC:MARK:MAX;Y?", ibsta, iberr, ibcnt1)
    Response = Space$(100)
    Call RSDLLibrd(ud, Response, ibsta, iberr, ibcnt1)
    Response = RTrim(Response) ' Cut off space

    ' Insert value in current document (Winword)
    Selection.InsertBefore (Response)
    Selection.Collapse (wdCollapseEnd)

    ' Terminate connection to measuring instrument
    Call RSDLLibonl(ud, 0, ibsta, iberr, ibcnt1)

End Sub
```

The entry of the peak value in the Winword document can be replaced as follows for Excel:

```
' Insert value in current document (Excel)
ActiveCell.FormulaR1C1 = Response
```

C / C++

Programming tips:

- Access to the functions of the RSIB32.DLL (Windows platforms)

The functions of the RSIB32.DLL are declared in the header file RSIB.H. The DLL functions can be linked to a C/C++ program in different ways.

1. Enter one of the supplied import libraries (RSIB.LIB or RSIB32.LIB) into the linker options.
2. Load the library using the function `LoadLibrary()` during runtime and determine the function pointers of the DLL functions using `GetProcAddress()`. Before the end of the program, the RSIB.DLL must be unloaded again using the function `FreeLibrary()`.

When import libraries are used, the DLL is automatically loaded immediately before the application is started. At the end of the program, the DLL is unloaded again unless it is still used by other applications.

- Access to `libsib.so` functions (UNIX platforms)

The functions of `libsib.so` are declared in the header file RSIB.H. Uppercase/lowercase characters for file names are typically observed under UNIX. The library functions are linked to a C/C++ program by entering the `-libsib` linker option.

The *shared library* `libsib.so` is automatically loaded on starting the application. The accessibility (for example via standard path) of the library must be ensured. Refer to the beginning of this main chapter under "UNIX Environment".

- Query of strings

If instrument responses are to be further processed as strings, a zero termination must be appended.

Example:

```
char buffer[100];
...
RSDLLibrd( ud, buffer, &ibsta, &iberr, &ibcntl );
buffer[ibcntl] = 0;
```

Programming example:

In the following C program example, a single sweep is started on the device with the IP address 89.10.38.97 and subsequently a marker is set to maximum level. Prior to the search for maximum, a synchronization to the end of the sweep is performed. For this purpose the command "*OPC" (Operation complete) is used to create a service request at the end of the sweep, for which the control program waits with the function RSDLLWaitSrq(). Then the maximum is determined ("CALC:MARK:MAX") and the level read out ("Y?").

```
#define MAX_RESP_LEN 100

short          ibsta, iberr;
unsigned long  ibcntl;
short         ud;
short         srq;
char          MaxPegel[MAX_RESP_LEN];
char          spr;

// Determine handle for instrument
ud = RSDLLibfind( "89.10.38.97", &ibsta, &iberr, &ibcntl );

// if instrument exists
if ( ud >= 0 )
{
    // Set timeout for RSDLLWaitSrq() to 10 seconds
    RSDLLibtmo( ud, 10, &ibsta, &iberr, &ibcntl );

    // Activate SRQ generation via event status register (ESR)
    // and enable ESB bit in SRE register
    RSDLLibwrt( ud, "*ESE 1;*SRE 32", &ibsta, &iberr, &ibcntl );

    // Set single sweep, trigger sweep and use "*OPC" to cause
    // the generation of a service request at the end of the sweep
    RSDLLibwrt( ud, "INIT:CONT off;INIT;*OPC", &ibsta, &iberr, &ibcntl );

    // Wait for SRQ (end of sweep)
    RSDLLWaitSrq( ud, &srq, &ibsta, &iberr, &ibcntl );

    // Clear RQS/MSS bit
    RSDLLibrsp( ud, &spr, &ibsta, &iberr, &ibcntl );

    // if sweep is terminated
    if (srq)
    {
        // then set marker to first maximum and query the level
        RSDLLibwrt( ud, "CALC:MARK:MAX;Y?", &ibsta, &iberr, &ibcntl );
        RSDLLilrd( ud, MaxPegel, MAX_RESP_LEN, &ibsta, &iberr, &ibcntl );
        MaxPegel[ibcntl] = 0;
    }
    // End connection to instrument
    RSDLLibonl( ud, 0, &ibsta, &iberr, &ibcntl );
}
else
{
    ; // Error Instrument not found
}
}
```

10 Index

Note: All softkeys are listed alphabetically under keyword "Softkey" with their names. The page numbers 4.xxx refer to the detailed description of the softkeys in chapter 4. Generally, the number of the page in chapter 6 containing the equivalent remote control command is given in addition. A list of softkeys and equivalent remote control commands or command sequences is given in chapter 6, section "Table of Softkeys with IEC/IEEE-Bus Command Assignment". Chapter 6 also contains an alphabetical list of all remote control commands.

*		
* (enhancement label)	3.7
* (enhancement lable)	4.106
0		
0 to 9 (key)	3.13
1		
1 - 2 (trace info)	4.116
1 - 3 (trace info)	4.116
10 dB setting	4.10
2		
20.4 MHz Out	8.12
3		
3 dB bandwidths	4.12
6		
6 dB bandwidths	4.12
7		
75 Ω (enhancement lable)	3.7
A		
Abort recording of correction data	4.118
AC supply connection	1.14
ACP measurement	4.151
Addressed command	8.5
Adjacent-channel power		
number of channels	4.158
Administrator function	1.17
AF demodulation	4.135
AF OUTPUT	8.2
AM demodulation	4.22, 4.136
AM modulation	4.285
AM modulation depth	4.178
Amplitude	4.76
Amplitude probability distribution function	4.172
Amplitude statistics	4.170
Analyzer mode	4.69
Annotation	4.200
AP (trace info)	3.6
APD function	4.172
Ascii #	5.14
ASCII file export		
final measurement data	4.27
scan data	4.66
Attenuation	4.9, 4.78
Autoppeak detector	4.113
AUX CONTROL interface	8.13
AUX CONTROL connector	8.13
AV (trace info)	3.6
Average detector	4.17, 4.18, 4.112, 4.115
Averaging	4.105, 4.149
continuous sweep	4.105
lin/log	4.107
single sweep	4.105
sweep count	4.105
AVG (trace info)	3.6
Axis adjustment	4.50
B		
BACK (key)	3.13
Band filter, digital	4.14, 4.86
Bandwidth		
occupied	4.167
resolution	4.82
video	4.82
Baud rate	4.223
Block data	5.14
Boolean parameter	5.13
Brightness	4.202
Brightness, Screen	4.261
C		
Cables EZ-xx	4.41
Calibration		
functioning	4.282, 4.297
reflection measurement	4.296
reflexion measurement	4.281
transmission measurement	4.275, 4.290

- Calibration results 4.118
 - CANCEL (key)..... 3.13
 - CCDF function..... 4.172
 - CCIR 473-4 4.101
 - CCVS signal..... 4.102
 - Center frequency..... 4.70
 - step size..... 4.70
 - Channel
 - power..... 4.161
 - bandwidth 4.159, 4.167, 4.177
 - number..... 4.158
 - spacing 4.160
 - Channel filters 4.15, 4.88
 - Channel power measurement..... 4.153
 - Characters, special 6.2
 - CISPR AVERAGE..... 6.165
 - CISPR average detector 4.17
 - Clear/Write mode 4.63, 4.104
 - CLWR (trace info) 3.6
 - Colon..... 5.14
 - Color 4.202, 4.260
 - Color printout..... 4.260
 - COM interface..... 4.223, 8.7
 - Comma 4.27, 5.14
 - Command
 - #..... 5.14
 - addressed 8.5
 - colon 5.14
 - comma 5.14
 - description 6.1
 - hp compatibility..... 6.251
 - line 5.11
 - long form..... 5.10
 - overlapping execution 5.17
 - programming examples 7.1
 - query..... 5.12
 - question mark 5.12, 5.14
 - quotation mark 5.14
 - recognition 5.16
 - sequence 5.17
 - short form..... 5.10
 - structure..... 5.8
 - suffix 5.10
 - syntax elements..... 5.14
 - universal 8.5
 - white space..... 5.14
 - Common commands 6.4
 - CONDition register part 5.19
 - Configuration..... 4.203
 - save 4.238
 - Connection cables..... 4.41
 - Continue single sweep 4.91
 - Continuous sweep..... 4.90
 - Control
 - output level 4.274
 - Control characters..... 8.9
 - Copy
 - file..... 4.252
 - limit line..... 4.186
 - trace..... 4.68, 4.110
 - Correction
 - inherent noise 4.155
 - Correction data..... 4.117
 - Correction of entry..... 3.19
 - Correction values
 - normalization..... 4.272, 4.287
 - Counter resolution..... 4.123
 - Coupling
 - bandwidths..... 4.80
 - default settings..... 4.84, 4.86
 - frequency of diagrams..... 4.199
 - IF bandwidth to frequency range..... 4.14, 4.19
 - reference level of diagrams..... 4.199
 - resolution bandwidth..... 4.83
 - sweep time 4.84
 - video bandwidth..... 4.83
 - Create directory 4.251
 - Cumulative distribution function 4.172
- ## D
- Data reduction 4.23
 - Date..... 4.200
 - input 4.226
 - DCL 5.16
 - Decimal point..... 3.13
 - Decimal separator..... 4.27
 - Default
 - coupling ratios 4.84
 - display settings..... 4.201
 - scalings of x- and y-axis 4.174
 - scan table..... 4.44
 - Delay, gate signal 4.98
 - Delete
 - file..... 4.252
 - limit line 4.186
 - line of peak list..... 4.26
 - line of transducer table 4.215
 - scan range..... 4.50
 - transducer factor/set..... 4.211
 - Demodulation..... 4.22, 4.135
 - Detector
 - autopeak..... 4.111
 - average 4.17, 4.18, 4.112
 - CISPR 4.17
 - max peak..... 4.17, 4.18, 4.111
 - min peak..... 4.17, 4.18, 4.111
 - quasipeak 4.112
 - quasi-peak..... 4.17, 4.18, 4.62, 4.64
 - RMS 4.17, 4.19, 4.112
 - sample..... 4.111
 - Device reset (overall) 4.4
 - discontinuous interferences 4.44
 - Diskette, format..... 4.254
 - Display
 - brightness..... 4.202
 - color 4.202
 - date 4.200
 - deactivation during single sweep 4.92
 - power-save mode 1.16, 4.201
 - saturation..... 4.202
 - time 4.200
 - tint 4.202
 - title..... 4.200
 - Display line 4.193
 - Display mode
 - full screen 3.9, 4.196
 - split screen 3.9, 4.197
 - Display range
 - frequency..... 4.70
 - level..... 4.9, 4.76
 - span 4.74
 - Distribution function 4.172
 - Double dagger 5.14
- ## E
- Editing
 - limit line 4.187
 - parameter 3.18

- table 3.25
 - Electrostatic discharge 1.12
 - ENABle register part 5.19
 - Enabling the front panel keys 4.3
 - Enhancement labels 3.7
 - ENTER (key) 3.13
 - Entry
 - abort 3.13
 - activate 3.16, 3.27
 - correct 3.19
 - terminate 3.13
 - ENV 4200 4.39
 - Error messages 4.233, 9.1
 - Error variable - *iberr* 4.340
 - Error-queue query 5.32
 - ESC (key) 3.13
 - ESE (event status enable register) 5.22
 - ESH2-Z5 4.39
 - ESH3-Z5 4.39
 - ESR (event status register) 5.22
 - EVENT register part 5.19
 - Event status enable register (ESE) 5.22
 - Event status register (ESR) 5.22
 - EXT (enhancement label) 3.7
 - EXT TRIGGER/GATE input 4.54, 4.94, 8.11
 - External generator 4.287
 - External noise source 4.205
 - EZ-14 4.41
 - EZ-21 4.41
 - EZ-5 4.41
 - EZ-6 4.41
- F**
- Fast power measurement 4.156
 - FFT filter 4.14, 4.86
 - Field, first or second 4.101
 - File
 - copy 4.252
 - delete 4.252
 - rename 4.252
 - sort 4.253
 - Filter
 - band filter 4.14, 4.86
 - FFT 4.14, 4.86
 - Final measurement
 - automatic routine 4.30
 - continuation 4.32
 - halt 4.32
 - interactive routine 4.31, 4.36
 - interruption 4.32
 - measurement time 4.30, 4.36
 - start 4.31
 - FINAL PHASES 4.40
 - Firmware update 4.237
 - Firmware version 4.232
 - Fixed filter 4.86
 - FM demodulation 4.22, 4.136
 - FM modulation 4.285
 - Free-run sweep 4.53, 4.93
 - Frequency
 - axis labelling 3.4
 - center 4.70
 - counter 4.123
 - coupling of diagrams 4.199
 - display window 4.74
 - Line 4.194
 - offset 4.73
 - Offset (ext. generator) 4.298
 - offset (tracking generator) 4.283
 - receiver 4.7
 - scan 4.47
 - span 4.74
 - start 4.72
 - stop 4.72
 - switching off display 4.200
 - Frequency-converting measurements 4.283, 4.298
 - FRQ (enhancement label) 3.7
 - Full screen 3.9, 4.196
 - Full span 4.74
- G**
- GAT (enhancement label) 3.7
 - Gate
 - delay 4.98
 - external/internal 4.96
 - length 4.98
 - GET (Group Execute Trigger) 5.16
 - Getting Started with the Instrument 1.12
 - GHz-dBm (key) 3.13
- H**
- Hardcopy
 - screen 4.256
 - Hardware adjustment 4.237
 - Hardware settings, indication 3.4
 - Header 5.9
 - Help line editor 3.22
 - Hold scan 4.52
 - Horizontal sync signal 4.101
 - Hotkey
 - MIXED 4.2
 - NETWORK 4.272
 - RECEIVER 4.2, 4.6, 6.112
 - SCREEN A/B 4.2, 6.94
 - SPECTRUM 4.1, 4.69, 6.112
 - Hue, Screen 4.261
 - Hz/dB. (key) 3.13
- I**
- I/Q modulation 4.286
 - IEC Bus
 - Interface 8.13
 - IEC/IEEE bus
 - address 4.220
 - command description 6.1
 - interface 8.3
 - interface functions 8.4
 - programming examples 7.1
 - IF bandwidth 4.12
 - coupling to frequency range 4.14, 4.19
 - IFOVL 3.5
 - Impedance of input 4.79
 - Indication
 - hardware settings 3.4
 - instrument settings 3.7
 - marker information 3.4
 - Inherent noise, Correction 4.155
 - Initial configuration 4.4
 - Input
 - EXT TRIGGER/GATE 4.54, 4.94, 8.11
 - REF IN 8.12
 - Input impedance 4.79

- Instrument functions 4.1
Interface functions IEC/IEEE bus 8.4
Interfaces 8.2
Intermodulation product 4.179
Interrupt 5.31
Interrupt scan 4.52
IST flag 5.22
- K**
- Key
0 to 9 3.13
AMPT 4.9, 4.76
BACK 3.13
BW 4.12, 4.81
CAL 4.117
CANCEL 3.13
DISP 4.195
ENTER 3.13
ESC 3.13, 6.20
FILE 4.238
FREQ 4.69
GHz/dBm 3.13
Hz/dB 3.13
kHz/dB 3.13
LINES 4.183, 4.193
MEAS 4.145
MHz/dBm 3.13
MKR 4.55, 4.119
MKR FCTN 4.61, 4.127
MKR to 4.56, 4.137
PRESET 4.4, 6.6, 6.221
SETUP 4.203
SPAN 4.74
spinwheel 3.14
SWEEP 4.46, 4.90
TRACE 4.62, 4.103
TRIG 4.53, 4.93
- Keyboard
connect 1.18
connector 8.2
kHz/dB (key) 3.13
- L**
- LAN Interface 4.305
Level 4.76
axis unit 4.11
display range 4.76
line 4.194
offset (phase noise) 4.131
offset (tracking generator) 4.274
range 4.76
reference 4.76
Level display 4.9
Limit
ACP measurement 4.163
evaluation range 4.148
probability range 4.174
Limit check 4.185
ACP measurement 4.163
Limit Check 4.185
Limit line
copy 4.186
delete 4.186
domain 4.188
edit 4.187
limit check 4.185
offset 4.186
save 4.192
scaling 4.189
select 4.184
shift 4.192
unit 4.190
value 4.191
- Line
Frequency (Frequency Line 1, 2) 4.194
level (Display Line 1,2) 4.194
limit 4.184
reference (tracking generator) 4.278, 4.293
threshold 4.59, 4.140
Time (Time Line 1, 2) 4.194
Line Impedance Stabilization Networks 4.39
Line system 4.102
Lines 4.194
LISN 4.39
LO exclude 4.144
Login/out (XP controller) 1.17
Logo 4.200
Lower case 6.2
LPT interface 8.6
- M**
- Maintenance 8.1
Manual operation
return to 5.4, 5.6
switch to 4.3
Margin 4.30, 4.35
Marker 4.119
center frequency to 4.138
CF stepsize to 4.58, 4.141
indication 3.4
N dB Down 4.132
normal 4.119
peak 4.57, 4.128, 4.138
reference level to 4.138
search limit 4.59, 4.139
signal track 4.73
to trace 4.55, 4.61, 4.122, 4.136
zoom 4.126
Max hold 4.63, 4.104
Max peak detector 4.17, 4.18, 4.114
MAXH (trace info) 3.6
Maximum peak value 4.149
Maximum search 4.57, 4.138
Maximum value 4.147
Mean power (GSM burst) 4.148
Mean value 4.148
Measurement
examples 2.1
frequency-converting 4.283, 4.298
reflection 4.296
reflexion 4.281
time 4.20
transmission 4.275, 4.290
Measurement converters 4.208
Measurement example
ACP with user-specific channel configuration 4.165
adjacent-channel power for a specific standard 4.164
CCDF of a IS95 BTS signal 4.175
occupied bandwidth of a PDC signal 4.169
signal/noise power density (C/No) of an IS95 CDMA
signal 4.166
Measurement of Carrier/Noise Ratio C/N and C/No 4.176
Measurement, save 4.238
Menu
call 3.12

change keys.....	3.12
Messages.....	4.233
acknowledgement.....	3.8
MHz/dBm (key).....	3.13
MI (trace info).....	3.6
Min hold.....	4.66, 4.107
Min peak detector.....	4.17, 4.18, 4.114
MINH (trace info).....	3.6
Minimum search.....	4.58, 4.141
Mobile radio standard.....	4.154
Mode	
analyzer.....	4.69
receiver.....	4.6
Modulation, external (tracking generator).....	4.284
Modulation depth.....	4.178
Monitor	
connection.....	1.20
connector.....	8.11
Mouse	
connection.....	8.12
connector.....	8.2
N	
Network.....	4.272
Noise	
source, external.....	4.205
Noise measurement.....	4.128
NOISE SOURCE.....	8.11
Noise, Correction.....	4.155
Normalization.....	4.277, 4.292
NTRansition register part.....	5.19
Numerical values (command).....	5.13
O	
Occupied bandwidth.....	4.167
Offset	
frequency.....	4.73
frequency (ext. generator).....	4.298
gate signal.....	4.98
level (tracking generator).....	4.274
limit line.....	4.186
phase noise.....	4.131
reference level.....	4.79
trigger.....	4.94
Operating mode	
analyzer.....	4.69
receiver.....	4.6
Receiver.....	4.6
Operating time.....	4.232
Option	
ESPI-B2 - PRESELECTOR.....	4.10
FSP-B10 – External Generator.....	4.287
FSP-B6 – TV and RF Trigger.....	4.100
FSP-B9 – Tracking Generator.....	4.272
Order number.....	4.231
Output	
AF OUTPUT.....	8.2
IF 20.4 MHz Out.....	8.12
noise source control.....	8.11
REF OUT.....	8.12
Output level	
control.....	4.274
OVEN.....	3.5
Overwrite mode.....	4.63, 4.104
OVLd.....	3.5, 4.282, 4.297

P

Packing.....	8.1
Parallel poll.....	5.32
Parallel poll enable register (PPE).....	5.22
Parameter	
block data.....	5.14
boolean.....	5.13
editing.....	3.18
numerical values.....	5.13
selection.....	3.15
string.....	5.14
text.....	5.14
Parameter coupling.....	4.197
Password	
service functions.....	4.235
Windows XP.....	1.17
Path.....	4.251
Peak	
detector.....	4.17, 4.64
Peak excursion.....	4.60
Peak list.....	4.25
PEAK LIST ON / OFF.....	4.65
Peak search.....	4.57, 4.128, 4.138
PHASE N.....	4.40
Phase noise measurement.....	4.130
Phase setting.....	4.40
PK (trace info).....	3.6
Polarity	
external trigger/gate.....	4.97
trigger edge.....	4.54, 4.94
video.....	4.102
Power bandwidth percentage.....	4.167
Power cables.....	8.1
Power measurement.....	4.145
CP/ACP.....	4.151
Fast.....	4.156
occupied bandwidth.....	4.167
signal amplitude statistics.....	4.170
Time domain.....	4.146
trace.....	4.163
Power, mean.....	4.148
Power-save mode	
display.....	1.16
hard disk.....	1.16
PPE (parallel poll enable register).....	5.22
Preamplification.....	4.10, 4.206, 4.207
Preparing the Instrument for Operation.....	1.12
PRESCAN PHASES.....	4.40
Preselection.....	4.206
Preset instrument.....	4.4
Pretrigger.....	4.94
PRINT SCREEN (Gate Signal).....	4.98
Printer	
configuration.....	4.255
connection.....	1.21, 4.257, 8.6
interface.....	8.6
start.....	4.256
PRN (enhancement lable).....	3.7
Probe Power connector.....	8.2
Protective earth conductor.....	4.40
Protective earth setting.....	4.40
PTRansition register part.....	5.19
Putting into operation	
AC supply connection.....	1.14

Q

QP (trace info).....	3.6
Quasi-peak detector.....	4.17, 4.18, 4.62, 4.64, 4.112
Query.....	5.12, 5.32
Question mark.....	5.12, 5.14
Quotation mark.....	5.14

R

Rackmounting.....	1.13
Receiver.....	4.6
frequency.....	4.7
frequency stepsize.....	4.8
level.....	4.9
Recording the correction data.....	4.117
Reference	
dataset (tracking generator).....	4.282
external.....	4.205
fixed.....	4.124
frequency.....	4.124
level to marker level.....	4.138
line (tracking generator).....	4.278, 4.293
position for normalization.....	4.293
Reference data set	
ext.generator.....	4.297
Reference level.....	4.76
channel power.....	4.156
coupling of diagrams.....	4.199
offset.....	4.79
position.....	4.79
to marker level.....	4.138
Reference point	
frequency.....	4.124
frequency (phase noise).....	4.132
level.....	4.124
offset.....	4.124
level (phase noise).....	4.131
offset.....	4.131
time.....	4.125
x axis.....	4.125
Reference value	
channel power.....	4.155
time domain power.....	4.149
Reflection measurement.....	4.281, 4.296
Remote control	
basics.....	5.1
IEC/IEEE bus.....	5.4
RS-232-C.....	5.5
switch over.....	5.3
Remote Control	
RSIB.....	4.337
Rename	
directory.....	4.252
file.....	4.252
Reset	
device.....	4.4
status reporting system.....	5.33
Resolution bandwidth.....	4.13, 4.82
Resolution counter.....	4.123
RF attenuation.....	4.9, 4.78
RFI reception.....	4.6
RM (trace info).....	3.6
RMS detector.....	4.17, 4.19, 4.112, 4.114
RMS value.....	4.147
RS-232-C	
configuration.....	4.223
interface.....	8.7
transmission parameters.....	8.8

S

SA (trace info).....	3.6
Sample detector.....	4.114
Sample number.....	4.173
Saturation.....	4.202
Saturation, Screen.....	4.262
Save	
configuration.....	4.238
limit line.....	4.192
measurement.....	4.238
Scalar reflection measurement.....	4.281, 4.296
Scaling.....	4.77
level axis.....	4.79
limit line.....	4.189
x- and y-axis (signal statistic).....	4.173
Scan.....	4.43
default setup.....	4.44
entry.....	4.46
hold.....	4.52
run.....	4.52
stop.....	4.52
SCPI	
conformity information.....	6.1
introduction.....	5.8
version.....	5.1
Screen.....	3.1
brightness.....	4.261
Colors.....	4.262
full screen.....	4.196
hue.....	4.261
Saturation.....	4.262
split screen.....	3.9, 4.197
subdivision.....	3.2
Screen, Colors.....	4.262
Search	
bandwidth.....	4.73
minimum.....	4.58, 4.141
peak.....	4.57, 4.128, 4.138
peak excursion.....	4.60
PEAK EXCURSION.....	4.134, 4.142
range.....	4.59, 4.139
Search method for peak list.....	4.30
Selftest.....	4.236
Sensitivity	
APD measurement.....	4.174
CCDF measurement.....	4.174
Serial interface.....	8.7
configuration.....	4.223
Serial number.....	4.231
Serial poll.....	5.31
Service functions.....	4.234
Service Pack.....	1.17
Service request (SRQ).....	5.21, 5.31
Service request enable register (SRE).....	5.21
Setting Up the Instrument.....	1.12
Settings, indication.....	3.7
Setup.....	4.203
general.....	4.220
SGL (enhancement label).....	3.7
Shutdown (NT controller).....	1.17
Sign (key).....	3.13
Signal amplitude statistics.....	4.170
Signal count.....	4.123
Signal tracking.....	4.73
search bandwidth.....	4.73
Single sweep.....	4.90
Softkey	
% POWER BANDWIDTH.....	4.167, 6.185
= CENTER.....	4.71, 4.72
= MARKER.....	4.71, 4.72
0.1 * RBW.....	4.71, 6.168, 6.169

0.1 * SPAN.....	4.70, 6.168, 6.169	CONT AT REC FREQ	4.52, 6.106
0.5 * RBW.....	4.71, 6.168, 6.169	CONT DEMOD.....	4.136, 6.52
0.5 * SPAN.....	4.70, 6.168, 6.169	CONT MEAS.....	4.175, 6.106, 6.107
1 MHz.....	4.13, 6.153	CONTINUE SGL SWEEP.....	4.91, 6.106, 6.107
10 dB MIN.....	4.78	CONTINUOUS SCAN.....	4.51, 6.106
10 DB MIN ON/OFF.....	4.10, 6.109	CONTINUOUS SWEEP.....	4.89, 4.90, 6.106, 6.107
120 kHz.....	4.13, 6.153	COPY.....	4.252, 4.253, 6.118
200 Hz.....	4.13, 6.153	COPY LIMIT LINE.....	4.186, 6.20
9 kHz.....	4.13, 6.153	COPY TRACE.....	4.68, 4.110, 6.225
ABSOLUTE PEAK/MIN.....	6.12, 6.13	COUPLING DEFAULT.....	4.86, 6.154, 6.191
ACP LIMIT CHECK.....	4.163, 6.22	COUPLING RATIO.....	4.84, 6.154
ACP REF SETTINGS.....	4.160, 6.184	COUPLING TABLE.....	4.197
ADD TO PEAK LIST.....	4.57	CP/ACP ABS/REL.....	4.161, 6.183
ADJ CHAN BANDWIDTH.....	4.159, 6.183	CP/ACP CONFIG.....	4.158, 6.22, 6.182
ADJ CHAN SPACING.....	4.160, 6.182	CP/ACP ON/OFF.....	4.153, 6.59, 6.60, 6.63
ADJUST AXIS.....	4.50	CP/ACP STANDARD.....	4.154, 6.63
ADJUST REF LVL.....	4.156, 4.168, 6.185	DATA SET CLEAR.....	4.248, 6.122
ADJUST SETTINGS.....	4.174, 4.177, 6.80, 6.185	DATA SET LIST.....	4.248
ADJUST SETTINGS (occupied bandwidth).....	4.168	DATAENTRY OPAQUE.....	4.201
ADJUST SETTINGS (power measurements).....	4.162	dBm.....	4.11, 4.77, 6.84, 6.237
ALL MARKER OFF.....	4.126, 6.10, 6.40	dBmV.....	4.77, 6.84, 6.237
AM.....	4.22, 4.136, 6.51, 6.16, 6.233	dBpT.....	4.11, 6.84, 6.237
AMPERE.....	4.77, 6.84, 6.237	dBpW.....	4.77, 6.84, 6.237
ANNOTATION ON/OFF.....	4.200, 6.92	dBµA.....	4.11, 4.77, 6.84, 6.237
APD ON/OFF.....	4.172, 6.79, 6.81	dBµV.....	4.11, 4.77, 6.84, 6.237
area.....	3.10	DECIM SEP.....	4.27, 4.68, 4.110, 4.254, 6.100
ASCII FILE EXPORT.....	4.27, 4.66, 4.108, 4.254, 6.100, 6.122	DEFAULT COLORS.....	4.201, 6.93, 6.101
AUTO COARSE.....	4.8	DEFAULT CONFIG.....	4.247, 6.125
AUTO FINE.....	4.8	DEFAULT SETTINGS.....	4.174, 6.81
AUTO RANGE ON/OFF.....	4.10	DELETE.....	4.252, 6.119, 6.121, 6.160, 6.162
AUTO SELECT.....	4.113, 6.164	DELETE (peak list).....	4.26
AUTOMATIC FINAL.....	4.30, 4.32, 4.36	DELETE FACTOR/SET.....	4.211
AUTOPREAMP ON/OFF.....	4.10, 6.111	DELETE LIMIT LINE.....	4.186, 6.21
AVERAGE.....	4.18, 4.64, 4.105, 6.98, 6.151, 6.165	DELETE RANGE.....	4.50, 4.218
AVERAGE ON/OFF.....	4.149, 6.68, 6.69, 6.71, 6.72, 6.73	DELETE VALUE.....	4.192
AVG MODE LOG/LIN.....	4.107, 6.77, 6.152	DEMOD.....	4.22
BARGRAPH MAXHOLD.....	4.198	DEMOD ON/OFF.....	4.22, 6.163
BARGRAPH RESET.....	4.199	DETECTOR.....	4.18, 4.64, 4.113, 6.164
BLANK.....	4.64, 4.106, 6.98	DETECTOR AUTOPEAK.....	4.113, 6.164
BRIGHTNESS.....	4.202, 4.261, 6.93, 6.102	DETECTOR AVERAGE.....	4.115, 6.164
C/N.....	4.176, 4.177	DETECTOR MAX PEAK.....	4.114, 6.164
C/No.....	4.177	DETECTOR MIN PEAK.....	4.114, 6.164
CAL ABORT.....	4.118, 6.85	DETECTOR QPK.....	4.115, 6.164
CAL CORR ON/OFF.....	4.118, 6.86	DETECTOR RMS.....	4.114, 6.164
CAL GEN 128 MHZ.....	4.235, 6.87	DETECTOR SAMPLE.....	4.114, 6.164
CAL REFL OPEN.....	4.281, 4.296, 6.157, 6.158	DEVICE 1/2.....	4.256, 6.103, 6.104, 6.105, 6.121, 6.217
CAL REFL SHORT.....	4.281, 4.296, 6.157, 6.158	DISABLE ALL ITEMS.....	4.198
CAL RESULTS.....	4.118, 6.86	DISPLAY LINE 1.....	4.194
CAL TOTAL.....	4.117, 6.85	DISPLAY PWR SAVE.....	4.201, 6.92
CAL TRANS.....	4.276, 4.291, 6.157	EDIT.....	4.211, 4.212, 4.216, 6.159, 6.161
CCDF ON/OFF.....	4.172, 6.79, 6.81	EDIT ACP LIMITS.....	4.163, 6.22, 6.23, 6.24, 6.25, 6.26, 6.27, 6.28, 6.29
CCVS INT / EXT.....	4.102, 6.195	EDIT COMMENT.....	4.245, 6.125
CENTER.....	4.70, 6.168	EDIT FREQUENCY.....	4.26
CENTER = MKR FREQ.....	4.138, 6.54	EDIT LIMIT LINE.....	4.188, 6.19, 6.31, 6.32, 6.34, 6.36, 6.37, 6.38
CENTER A = MARKER B.....	4.199, 6.113	EDIT PATH.....	4.245, 4.251, 6.117, 6.121
CENTER B = MARKER A.....	4.199, 6.113	EDIT PEAK LIST.....	4.26, 4.35
CF STEPSIZE.....	6.168	ENABLE ALL ITEMS.....	4.198
CHAN PWR / HZ.....	4.161, 6.62	ENABLE ALL ITEMS.....	4.247, 6.124
CHAN PWR ACP.....	4.153, 6.59	ENTER PASSWORD.....	4.235, 6.220
CHANNEL BANDWIDTH.....	4.167, 4.177, 6.183	ESH2-Z5/ENV 4200.....	4.39, 6.16, 6.109
CHANNEL SPACING.....	6.181	ESH3-Z5.....	4.39, 6.167, 6.109
CISPR AVERAGE.....	4.19	EXCLUDE LO.....	4.144, 6.43
CLEAR ALL MESSAGES.....	4.233, 6.219	EXT AM.....	4.285
CLEAR/WRITE.....	4.63, 4.104, 6.98	EXT AMFSP.....	6.196
CNT RESOL.....	4.123, 6.42	EXT FM.....	4.285, 6.197
COLOR ON/OFF.....	4.260, 6.103	EXT I/Q.....	4.286, 6.196
COLORS.....	4.257, 4.260	EXT SOURCE.....	4.299
COM INTERFACE.....	4.223, 6.216	EXT SRC ON/OFF.....	4.300, 6.199
COMMENT SCREEN A/B.....	6.105	EXTERN.....	4.54, 4.94, 6.193, 6.233
CONFIGURE NETWORK.....	4.227		
CONT AT HOLD.....	4.52		

- FAST ACP ON/OFF..... 4.156, 6.186
 FILE MANAGER..... 4.250, 6.117
 FILTER TYPE..... 4.86, 6.155
 FINAL AVERAGE..... 4.65, 6.165
 FINAL CISPR AV..... 4.65
 FINAL MAX PEAK..... 4.65, 6.165
 FINAL MEAS TIME..... 4.30, 4.36, 6.167
 FINAL MIN PEAK..... 4.65, 6.165
 FINAL PHASES..... 4.40, 6.109
 FINAL QUASIPeAK..... 4.65, 6.165
 FINAL RMS..... 4.65, 6.165
 FIRMWARE UPDATE..... 4.237, 6.219
 FM..... 4.22, 4.136, 6.51, 6.163, 6.233
 FORMAT DISK..... 4.254, 6.119
 FREE RUN..... 4.53, 4.93, 6.233
 FREQ AXIS LIN/LOG..... 4.51, 4.75, 6.95
 FREQUENCY LINE 1/2..... 4.194
 FREQUENCY OFFSET..... 4.73, 4.283, 4.298, 6.170, 6.197
 FREQUENCY SWEEP..... 4.303, 6.200, 6.201
 FSP MODE ON/OFF..... 6.221
 FULL SCREEN..... 4.196, 6.92
 FULL SIZE DIAGRAM..... 4.156
 FULL SPAN..... 4.74, 6.169
 GATE DELAY..... 4.98, 6.193
 GATE LENGTH..... 4.98, 6.193
 GATE MODE LEVEL/EDGE..... 4.97, 6.193
 GATE SETTINGS..... 4.97, 6.192
 GATED TRIGGER..... 4.96, 6.192, 6.193
 GEN REF INT/EXT..... 4.304
 GENERAL SETUP..... 4.220
 GPIB..... 4.220
 GPIB ADDRESS..... 4.220, 6.213
 GPIB LANGUAGE..... 4.221
 GRID ABS/REL..... 4.79, 6.95
 GRID MIN LEVEL..... 4.11, 6.97
 GRID RANGE LOG 100 dB..... 4.11
 GRID RANGE LOG MANUAL..... 4.11
 HARDCOPY ABORT..... 6.101
 HARDWARE INFO..... 4.231, 6.6, 6.89
 HOLD FINAL MEAS..... 4.32
 HOLD SCAN..... 4.52, 6.8
 HOR SYNC..... 4.101, 6.236
 ID STRING FACTORY..... 4.220
 ID STRING USER..... 4.221
 IF POWER..... 4.94, 6.193, 6.233, 6.235
 INPUT CAL..... 4.234, 4.235, 6.87, 6.88
 INPUT RF..... 4.234, 4.235, 6.87
 INS AFTER RANGE..... 4.50, 4.218
 INS BEFORE RANGE..... 4.50, 4.218
 INSERT (peak list)..... 4.26
 INSERT VALUE..... 4.191
 INSTALL OPTION..... 4.229
 INTERACTIVE..... 4.31, 4.32, 4.36
 ITEMS TO SAVE/RECALL..... 4.246, 6.123
 LAST SPAN..... 4.75
 LEFT LIMIT..... 4.59, 4.134, 4.140, 6.40, 6.41
 LIMIT ON/OFF..... 4.148, 6.40
 LINES 625 / 525..... 4.102, 6.236
 LISN..... 4.39
 LOCAL..... 4.3, 5.6
 LOGO ON/OFF..... 4.200, 6.92
 MAIN PLL BANDWIDTH..... 4.89
 MAKE DIRECTORY..... 4.251, 6.120
 MANUAL..... 4.71
 MARGIN..... 4.30, 4.35
 MARKER 1 to 44.55, 4.120, 6.10, 6.11, 6.39, 6.40, 6.43
 MARKER DEMOD..... 4.135, 6.51
 MARKER NORM/DELTA..... 4.55, 4.120, 6.9
 MARKER TRACK..... 4.57, 6.42
 MARKER ZOOM..... 4.61, 4.126, 6.51
 MAX HOLD..... 4.63, 4.104, 6.98
 MAX HOLD ON/OFF..... 4.149, 6.68, 6.70, 6.71, 6.73
 MAX PEAK..... 4.18, 4.64, 6.165
 MAX-MIN THRESHOLD..... 6.166
 MEAN..... 4.148, 6.70
 MEAS TIME..... 4.20
 MEASURE..... 4.32
 MIN..... 4.58, 4.141, 6.12, 6.45
 MIN HOLD..... 4.66, 4.107, 6.98
 MIN PEAK..... 4.64, 6.165
 MIXER LOW NOISE..... 4.78
 MKR -> CF STEPSIZE..... 4.58, 4.141, 6.55
 MKR -> STEPSIZE..... 6.55
 MKR -> TRACE.....
 4.55, 4.58, 4.61, 4.122, 4.136, 4.140, 6.10, 6.40
 MKR DEMOD ON/OFF..... 4.135, 6.52
 MKR STOP TIME..... 4.136, 6.52
 MODULATION..... 4.284
 MODULATION DEPTH..... 4.178, 6.53
 MODULATION OFF..... 4.286, 6.196, 6.197
 mult carr ACP..... 4.153
 N dB DOWN..... 4.132, 6.49, 6.50
 NAME..... 4.188, 6.19, 6.20, 6.21, 6.31, 6.32, 6.35, 6.37
 NETWORK..... 4.288
 NETWORK..... 4.288
 NETWORK LOGIN..... 4.228
 NEW..... 4.211, 4.212, 4.216, 6.160
 NEW LIMIT LINE.....
 4.188, 6.19, 6.20, 6.21, 6.31, 6.32, 6.34, 6.36
 NEXT MIN..... 4.58, 4.141, 6.13, 6.45, 6.46
 NEXT MIN LEFT..... 4.58, 4.142
 NEXT MIN RIGHT..... 4.58, 4.142
 NEXT PEAK..... 4.57, 4.139, 6.12, 6.13, 6.44
 NEXT PEAK LEFT..... 4.139
 NEXT PEAK RIGHT..... 4.139
 NO OF PEAKS..... 4.30, 4.35, 6.78
 NO OF SAMPLES..... 4.173, 6.79
 NO. OF ADJ CHAN..... 4.158, 6.182
 NO. OF TX CHAN..... 4.158, 6.182
 NOISE CORR ON/OFF..... 4.155, 6.186
 NOISE MEAS..... 4.128, 6.51
 NOISE SRC ON/OFF..... 4.205, 6.88
 NORMALIZE..... 4.277, 4.292, 6.157
 NUMBER OF SWEEPS..... 4.150, 6.192
 OCCUP BW ON/OFF..... 4.167, 6.59, 6.60, 6.63
 OCCUPIED BANDWIDTH..... 4.167, 6.59
 OPTIMIZED COLORS..... 4.261
 OPTIONS..... 4.229
 PARAM COUPLING..... 4.197
 PE FLOATING..... 4.40, 6.110, 6.167
 PE GROUNDED..... 4.40, 6.110, 6.167
 PEAK..... 4.57, 4.128, 4.138, 4.147, 6.11, 6.44, 6.67
 PEAK EXCURSION..... 4.60, 4.134, 4.142, 6.46
 PEAK LIST..... 4.133, 6.47
 PEAK LIST OFF..... 4.134, 6.47
 PEAK LIST ON/OFF..... 4.65, 6.98
 PEAK SEARCH..... 4.25, 4.132, 4.134, 6.78
 PEAKS/SUBRANGES..... 4.30, 6.78
 PERCENT MARKER..... 4.172, 6.44
 PH NOISE ON/OFF..... 4.131, 6.15, 6.16
 PHASE L1/L2/L3..... 4.40, 6.109, 6.167
 PHASE N..... 4.40, 6.109, 6.167
 PHASE NOISE..... 4.130, 6.15
 POLARITY POS/NEG..... 4.54, 4.94, 4.97, 6.193, 6.236
 PORT 0 0/1..... 4.222, 6.126
 POWER ABS/REL..... 4.149, 6.74, 6.198
 POWER ON/OFF..... 4.147, 6.67, 6.69, 6.70, 6.72, 6.74
 PREAMP ON/OFF..... 4.10, 4.207, 6.110
 PREDEFINED COLORS..... 4.202, 4.262, 6.94, 6.103
 PRESCAN PHASES..... 4.40, 6.109
 PRESELECT ON/OFF..... 4.207, 6.111
 PREVIOUS ZOOM..... 4.61
 PRINT SCREEN..... 4.98, 4.256, 6.104, 6.121
 PRINT TABLE..... 4.256, 6.104, 6.105, 6.121

PRINT TRACE	4.256, 6.104, 6.105, 6.121
PULSE FREQ	6.90
PULSE xx	4.235, 6.87
PWR OFFSET	4.274, 4.289
QP RBW UNCOUPLED	4.14, 4.19, 6.154
QUASISPEAK	4.18, 4.64, 6.165
RANGE	4.218
RANGE LINEAR	4.77, 6.97
RANGE LOG 100 dB	4.76, 6.97
RANGE LOG MANUAL	4.77, 6.97
RANGES 1-5/6-10	4.50
RBW / VBW MANUAL	4.85, 6.155
RBW / VBW NOISE [10]	4.85, 6.155
RBW / VBW PULSE [1]	4.85, 6.155
RBW / VBW SINE [1/3]	4.84, 6.155
RECALL	4.244, 4.295, 6.119, 6.158
RECEIVER FREQUENCY	4.7, 6.168
REF FXD ON/OFF	4.124, 6.14
REF LEVEL	4.76, 6.96
REF LEVEL = MKR LVL	4.138, 6.55
REF LEVEL COUPLED	4.199, 6.113
REF LEVEL OFFSET	4.79, 6.96
REF LEVEL POSITION	4.79, 6.97
REF POINT FREQUENCY	4.124, 4.132, 6.15
REF POINT LEVEL	4.124, 4.131, 6.14
REF POINT LVL OFFSET	4.124, 4.131, 6.15
REF POINT TIME	4.125, 6.15
REF POINT x-LEVEL	4.125, 6.15
REF VALUE	4.279, 4.294, 6.96
REF VALUE POSITION	4.278, 4.293, 6.97
REFERENCE FIXED	4.124, 6.14
REFERENCE INT/EXT	4.205, 6.187
REMOVE OPTION	4.229
RENAME	4.252, 6.120
RES BW	4.13, 4.173, 6.153
RES BW AUTO	4.83, 6.154
RES BW MANUAL	4.82, 6.153, 6.154
RESTORE FIRMWARE	4.237
RF ATTEN AUTO	4.78, 6.109
RF ATTEN MANUAL	4.9, 4.78, 6.108
RF INPUT 50 Ω / 75 Ω	4.79, 6.110
RF INPUT AC/DC	4.11, 4.78
RF POWER	4.100, 6.233, 6.235
RIGHT LIMIT	4.59, 4.134, 4.140, 6.40, 6.41
RMS	4.19, 4.64, 4.147, 6.69, 6.165
RUN FINAL MEAS	4.31, 4.36, 4.37
RUN SCAN	4.52, 6.107
SATURATION	4.202, 4.262, 6.93, 6.102
SAVE	4.243, 6.121
SAVE LIMIT LINE	4.192
SAVE TRD FACTOR	4.215
SAVE TRD SET	4.219
SCALING	4.173, 6.80
SCAN COUNT	4.64, 6.191, 6.192
SCREEN COLORS	4.261
SCREEN TITLE	4.200, 6.94, 6.95
SEARCH LIMIT OFF	4.60, 4.140, 6.40
SEARCH LIMITS	4.59, 4.139, 6.40
SEARCH NEXT LEFT	6.12, 6.13, 6.46
SEARCH NEXT PEAK LEFT	4.57
SEARCH NEXT PEAK RIGHT	4.57
SEARCH NEXT RIGHT	6.12, 6.13, 6.44, 6.46
SELECT GENERATOR	4.300, 6.214, 6.215
SELECT ITEMS	4.247, 6.123, 6.124
SELECT LIMIT LINE	4.184, 6.19, 6.20, 6.34, 6.37
SELECT MARKER	4.57, 4.128, 4.137, 4.181, 6.39
SELECT OBJECT	4.201, 4.261
SELECT TRACE	4.63, 4.73, 4.104, 4.163, 6.65, 6.186
SELFTEST	4.236, 6.7
SELFTEST RESULTS	4.236, 6.88
SERVICE	4.234, 6.87
SET CP REFERENCE	4.155, 6.184
SET REFERENCE	4.149, 6.74
SET TO DEFAULT	4.262
SETTINGS COUPLED	4.59, 6.43
SGL SWEEP DISP OFF	4.92, 6.107
SHIFT X LIMIT LINE	4.192, 6.32
SHIFT Y LIMIT LINE	4.192, 6.38
SIGNAL COUNT	4.123, 6.42
SIGNAL STATISTIC	4.172
SIGNAL TRACK	4.73, 6.64
SINGLE MEAS	4.175, 6.106, 6.107
SINGLE SCAN	4.51, 6.106
SINGLE SWEEP	4.90, 6.106, 6.107
SOFT FRONT PANEL	4.230
SORT BY DELTA LIMIT	4.27
SORT BY FREQUENCY	4.26
SORT MODE	4.253
SORT MODE FREQ/LEVEL	4.134
SOURCE CAL	4.275, 4.290
SOURCE ON/OFF	4.273
SOURCE POWER	4.274, 4.288, 6.197, 6.201
SPAN MANUAL	4.74, 6.169
SPAN/RBW AUTO [50]	4.85, 6.154
SPAN/RBW MANUAL	4.86, 6.154
SPLIT SCREEN	4.197, 6.92
STANDARD DEVIATION	4.148, 6.72
START	4.8, 4.72, 6.169
START LIMIT	4.148, 4.149, 6.41
STARTUP RECALL	4.249, 6.120
STATISTICS	4.232, 6.5
STEPSIZE	4.8
STEPSIZE = FREQ	4.8
STEPSIZE MANUAL	4.8, 4.72, 6.168
STOP	4.8, 4.72, 6.169
STOP FINAL MEAS	4.32
STOP LIMIT	4.148, 4.149, 6.41
STOP SCAN	4.52, 6.8
SWEEP COUNT	4.91, 4.106, 6.192
SWEEP POINTS	4.92, 6.194
SWEPTIME AUTO	4.84, 4.91, 6.191
SWEPTIME MANUAL	4.74, 4.83, 4.91, 6.191
SYSTEM INFO	4.231
SYSTEM MESSAGES	4.233, 6.219
T1-T2	4.116, 6.76
T1-T3	4.116, 6.76
THRESHOLD	4.59, 4.134, 4.140, 6.82, 6.83
THRESHOLD ON/OFF	4.35
THRESHOLD SCAN	6.166
TIME DOM POWER	4.146, 6.67, 6.69, 6.70, 6.72
TIME DOMAIN	4.51
TIME LINE 1/2	4.194
TIME+DATE	4.226, 6.218, 6.221
TIME+DATE ON/OFF	4.200, 6.95
TINT	4.202, 4.261, 6.93, 6.102
TOI	4.180, 6.54
TRACE MATH	4.116, 6.76
TRACE MATH OFF	4.116, 6.77
TRACE POSITION	4.116, 6.76
TRACK BW	4.73, 6.64
TRACK ON/OFF	4.73, 6.64
TRACK THRESHOLD	4.73, 6.65
TRACKING	4.273
TRANSDUCER	4.209, 6.158
TRANSDUCER FACTOR	4.210, 6.158, 6.159
TRANSDUCER SET	4.210, 6.160, 6.162
TRIGGER OFFSET	4.94, 6.235
TUNE TO MARKER	4.57, 6.54
TV TRIG SETTINGS	4.101
TV TRIGGER ON/OFF	4.101, 6.195
UNIT	4.11, 4.77, 6.84, 6.237
USE CURR SETTINGS	4.51
USE SCAN TABLE	4.47, 6.188, 6.189, 6.190
USER DEFINED	4.261

USER PORT	4.222
USER PORT IN/OUT	4.222, 6.110
VALUES	4.191, 6.31, 6.33, 6.36
VBW LIN LOG	4.89, 6.156
VERT SYNC	4.101, 6.236
VERT SYNC EVEN FIELD	4.101, 6.236
VERT SYNC ODD FIELD	4.101, 6.236
VIDEO	4.53, 4.93, 6.233, 6.235
VIDEO BW AUTO	4.83, 6.155
VIDEO BW MANUAL	4.82, 6.155
VIDEO POL POS / NEG	4.102, 6.236
VIEW	4.63, 4.106, 6.98
VIEW TRANSDUCER	4.211
VOLT	4.77, 6.84, 6.237
WATT	4.77, 6.84, 6.237
X * RBW	4.71, 6.168, 6.169
X * SPAN	4.70, 6.168, 6.169
X OFFSET	4.186, 6.32
X-AXIS RANGE	4.174, 6.80
X-AXIS REF LEVEL	4.173, 6.80
Y OFFSET	4.186, 6.34, 6.37
Y-AXIS MAX VALUE	4.174, 6.80
Y-AXIS MIN VALUE	4.174, 6.81
ZERO SPAN	4.74, 6.169
ZOOM OFF	4.61
ZOOM x-AXIS	4.98
Span	4.74
Special characters	6.2
Spectrum analyzer mode	4.69
Spinwheel	3.14
Split screen	3.9, 4.197
Squelch	4.135
SRE (service request enable register)	5.21
SRQ (service request)	5.21, 5.31
Standard deviation	4.148
Standard, mobile radio	4.154
Start frequency	4.72
Statistics	4.170
Status byte (STB)	5.21
Status information	3.5
IFOVL	3.5
OVEN	3.5
OVL	3.5
UNCAL	3.5
STATus OPERation register	5.23
STATus QUESTionable register	5.24
ACPLimit register	5.25
FREQUENCY register	5.26
LIMit register	5.27
LMARgin register	5.28
POWer register	5.29
TRANsducer	5.30
Status register	
CONDition part	5.19
ENABLE part	5.19
ESE	5.22
ESR	5.22
EVENT part	5.19
NTRansition part	5.19
overview	5.20
PPE	5.22
PTRansition part	5.19
SRE	5.21
STATus OPERation	5.23
STATus QUESTionable ACPLimit	5.25
STATus QUESTionable FREQUENCY	5.26
STATus QUESTionable LIMit	5.27
STATus QUESTionable LMARgin	5.28
STATus QUESTionable POWer	5.29
STATus QUESTionable TRANsducer	5.30
STB	5.21
structure	5.18
sum bit	5.19
Status reporting system	5.18
resetting values	5.33
STB (status byte)	5.21
Stepsize	4.72
center frequency	4.70
coupling	4.72
receiver frequency	4.8
Stop frequency	4.72
Store trace	4.254
Storing	8.1
String	5.14
Subrange maxima list	4.25
Suffix	5.10
Sum bit	5.19
Supply voltage, external noise source	4.205
Sweep	
continue single sweep	4.91
continuous	4.90
count	4.91
coupling	4.80
free run	4.53, 4.93
gated	4.95, 4.96
settings	4.90
single	4.90
time	4.74, 4.91
coupling	4.84
Switching cycles	4.232
Switching on/off	1.14
Sync signal	4.101
Syntax elements of commands	5.14
System messages	4.233
T	
T1-T2 (trace info)	3.6
T1-T3 (trace info)	3.6
Table	
operation	3.25
scrolling	3.27
TDF (enhancement table)	3.7
TDS (enhancement table)	3.7
Test	
functional	1.16
selftest	4.236
Test receiver	4.6
Text parameter	5.14
Third Order Intercept	4.179
Threshold	
line	4.59, 4.140
signal tracking	4.73
Time	4.200
input	4.226
Line	4.194
Time axis	4.74
time domain analysis	4.44
Tint	4.202
Title for the active diagram	4.200
TOI	4.179
Trace	4.62, 4.63, 4.103, 4.104
average	4.105
averaging	4.107
blank	4.64, 4.106
Clear/Write	4.63, 4.104
copy	4.68, 4.110
freeze	4.63, 4.106
math	4.116
max hold	4.63, 4.104
min hold	4.66, 4.107
position for 0 difference	4.116

power measurement	4.163
select	4.62, 4.103
signal tracking.....	4.73
Trace info.....	3.6
Tracking generator	4.272
Transducer.....	4.208
entry.....	4.212
set.....	4.216
switch on.....	4.209
Transmission measurement	4.275, 4.290
Transmission parameters RS-232-C/COM	8.8
TRG (enhancement table)	3.7
Trigger	
external.....	4.53, 4.54, 4.94
external gate	4.96
free run	4.53, 4.93
gated sweep	4.97
IF power.....	4.94
offset.....	4.94
RF power	4.100
scan.....	4.53
slope.....	4.54, 4.94
sweep	4.93
video.....	4.93
TUNE TO MARKER.....	4.57
TV trigger	4.101

U

UNCAL.....	3.5
Unit	
level axis.....	4.77
limit line.....	4.190
Unit (key).....	3.13
Universal command.....	8.5
Upper case.....	6.2
USB connection	8.12
User interface.....	4.222
User Interface.....	8.10
User port	
configuration	4.222

V

Vertical sync signal	4.101
Video bandwidth.....	4.82
Video polarity	4.102
Video triggering	4.93
VIEW (trace info).....	3.6
View trace	4.106
V-networks	4.39

W

Weighting modes	4.20
White space	5.14
Windows XP.....	1.17
administrator	1.17
login	1.17
password	1.17
shutdown	1.17
Windows-XP Servicepacks	1.17

X

XP computer.....	1.17
------------------	------

Z

Zero span	4.74
Zoom	4.126
amplitude.....	4.63, 4.106
x-AXIS (gate signal).....	4.98